

# CSD Series Current Devices—Split Core with Relay

## Installation Instructions

CSD-CF0J1-1  
CSD-CA1G1-1

Part No. 24-10345-42, Rev. E  
Issued March 31, 2014  
Supersedes April 5, 2013

Refer to the [QuickLIT website](#) for the most up-to-date version of this document.

### Applications

The Current Switch Device (CSD) Series of digital output switches are nonintrusive devices designed to detect current flowing through a cable or wire. A cost effective solution for monitoring on and off status or proof of operation, these units are ideal for monitoring small current loads on motors driving fans and blowers, heating coils, and lighting.

The CSD models with command relays not only monitor current flowing through the cable but also facilitate starting and stopping the motor.

These units provide a universal solid state output. Power for the current sensing circuit is derived from the current induced from the monitored cable or line. The command relay requires a separate 24 VAC/VDC supply.

**IMPORTANT:** The Current Switch Device (CSD) Series Current Devices are intended to provide an input to equipment under normal operating conditions. Where failure or malfunction of the CSD could lead to personal injury or property damage to the controlled equipment or other property, additional precautions must be designed into the control system. Incorporate and maintain other devices, such as supervisory or alarm systems or safety or limit controls, intended to warn of or protect against failure or malfunction of the CSD.

**IMPORTANT :** Le Current Switch Device (CSD) Series Current Devices est destiné à transmettre des données entrantes à un équipement dans des conditions normales de fonctionnement. Lorsqu'une défaillance ou un dysfonctionnement du CSD risque de provoquer des blessures ou d'endommager l'équipement contrôlé ou un autre équipement, la conception du système de contrôle doit intégrer des dispositifs de protection supplémentaires. Veiller dans ce cas à intégrer de façon permanente d'autres dispositifs, tels que des systèmes de supervision ou d'alarme, ou des dispositifs de sécurité ou de limitation, ayant une fonction d'avertissement ou de protection en cas de défaillance ou de dysfonctionnement du CSD.

**IMPORTANT:** Install the CSD Series Current Devices **only** on the **input** side of a variable speed drive. Otherwise excessive wear may occur on the controlled equipment, as well as premature failure of the CSD Series Current Devices.

### Installation



**WARNING: Risk of Electric Shock.**

Disconnect the power supply before making electrical connections. Contact with components carrying hazardous voltage can cause electric shock and may result in severe personal injury or death.

**AVERTISSEMENT : Risque de décharge électrique.**

Débrancher l'alimentation avant de réaliser tout branchement électrique. Tout contact avec des composants conducteurs de tensions dangereuses risque d'entraîner une décharge électrique et de provoquer des blessures graves, voire mortelles.



**WARNING: Risk of Personal Injury.**

Do not touch the relay while power is applied to the relay. The relay surface is hot during use, and may cause a serious burn upon contact.

**AVERTISSEMENT : Risque de blessure.**

Ne pas toucher le relais lorsque le relais est sous tension. La surface du relais devient extrêmement chaude durant son utilisation et risque de provoquer des brûlures graves en cas de contact.

## Dimensions

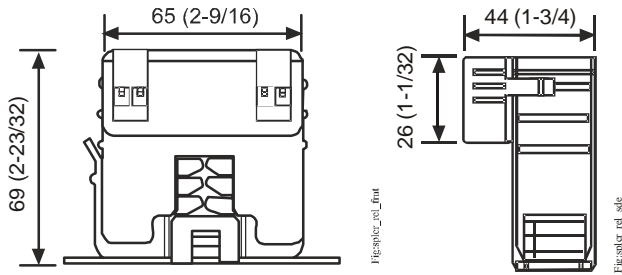

Figure 1: CSD Dimensions, mm (in.)

## Mounting

1. Using the two screws (included), attach the mounting bracket to the back of the electrical enclosure.
2. Snap the CSD into place on the mounting bracket.

## Wiring

1. Disconnect the power to the conductor cable from the power source.
2. Snap the split core around the power conductor cable to be monitored and close the core until the core snaps shut.
3. Wire the CSD/Command Relay as shown in Figure 2.
4. Reconnect the power to the conductor cable.

**Note:** The switch contacts are solid state and they work like dry contacts. When the switch is closed, less than 1 ohm is present; when the switch is open, more than 1 megohm is present.

5. Calibrate Model CSD-CA1G1-1 (see Setup and Adjustments).

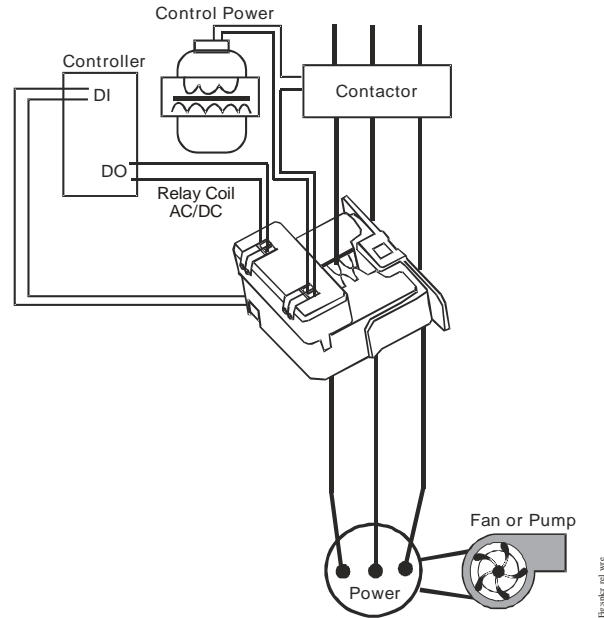

Figure 2: Models CSD-CF0J1-1/CSD-CA1G1-1

If the measured current is too low to be detected or higher than the maximum current rating of the CSD, use the appropriate method to increase or decrease current.

### ***If Measured Current Is Too Low to Be Detected***

Wrap the conductor (wire) through the sensing hole and around the CSD body to produce multiple turns to increase the measured current.

Measured current = actual current multiplied by the number of turns (see Figure 3).

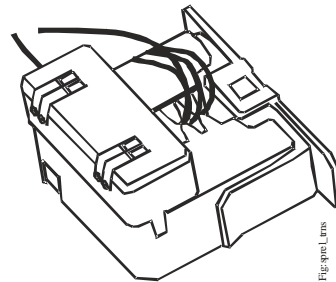

Figure 3: CSD Shown with Four Turns

**IMPORTANT:** Failure to derate the current capacity may result in damage to the CSD when using multiple turns to increase measured current. Use the following formula to determine the new maximum current:

New Maximum Current = CSD Current Rating/  
number of turns. For example, a Model  
CSD-CA1G1-1 with 4 turns =  $135 \text{ A}/4 = 33.8 \text{ A}$ , new  
maximum current.

### To Monitor Currents Exceeding the Maximum Current Rating of the CSD

For currents > 200 A (Model CSD-CF0J1-1)  
or > 135 A (Model CSD-CA1G1-1).

Use a 5 A Current Transformer (CT) to reduce the current passing through the CSD (see Figure 4). Run the current transformer secondary wire through the sensing hole. Terminate the two secondary wires of the 5 A current transformer to each other, and then install the 5 A current transformer on the monitored conductor.

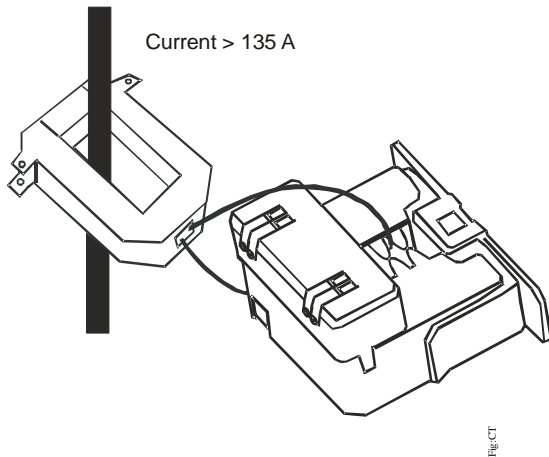

Figure 4: CSD with CT Transformer

## Setup and Adjustments

### Calibration

#### CSD Series Model CSD-CA1G1-1

Position the CSD so the status output panel faces you. Confirm the monitored load (for example, a motor or heater) is running, and use the following methods to calibrate the CSD.

### Under Current Status Condition (Belt Loss, Coupling Shear, Fan, and Pump Status)

1. Turn the setpoint screw clockwise until the Status Closed Light-Emitting Diode (LED) turns off and the Status Open LED turns on.

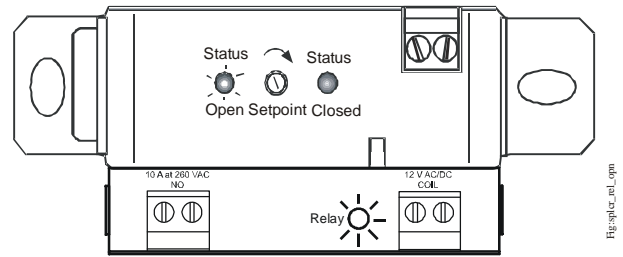

Figure 5: Status Open, LED On

2. Slowly turn the setpoint screw counterclockwise until the Status Closed LED turns on and the Status Open LED turns off.

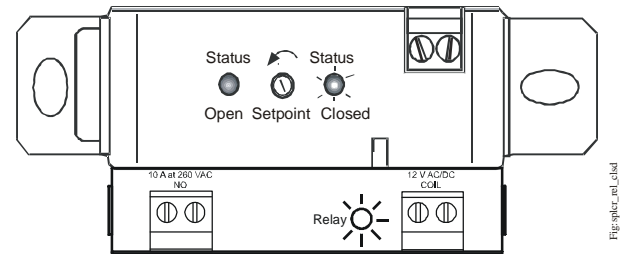

Figure 6: Status Open, LED Off

3. Turn the setpoint screw an additional 1/4 turn counterclockwise to create a deadband to prevent hunting.

The CSD is now calibrated to signal current flows below normal full load amperes.

Output Status:

- Normal: Output Closed
- Alarm: Output Open

### Over Current Status Condition (Locked Rotor, Seized Impeller)

1. Turn the setpoint screw counterclockwise until the Status Open LED turns off and the Status Closed LED turns on.

**Note:** This is the default factory setting.

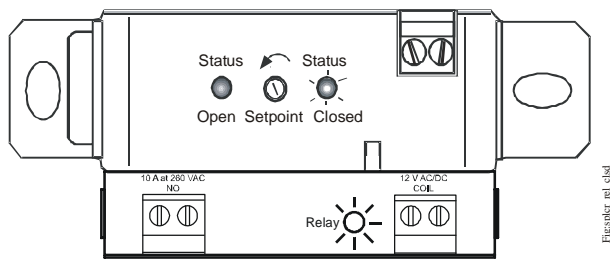

**Figure 7: Status Closed, LED On**

2. Slowly turn the setpoint screw clockwise until the Status Closed LED turns off and the Status Open LED turns on.

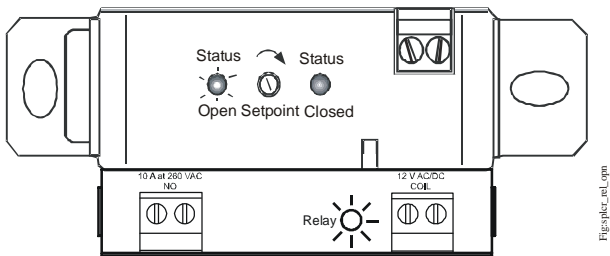

**Figure 8: Status Open, LED On**

3. Turn the setpoint screw an additional 1/4 turn clockwise to create a deadband to prevent hunting.

## Troubleshooting

**Table 2: Troubleshooting**

Symptom	Action
<b>CSD solid state output does not function.</b>	Verify the maximum amperage range has not been exceeded. Voltages or currents above the rated levels may damage the CSD.
<b>Setpoint screw keeps turning.</b>	The setpoint screw has a slip clutch to prevent damage at either end. To return the LED to its original setting, turn the setpoint screw 20 full turns counterclockwise and start the calibration procedure again.
<b>Motor is turned on and switch does not close.</b>	Insufficient current to the load leads (for example, a motor or heater) to reach the setpoint threshold. To turn the switch on, wrap the cable multiple times through the sensing hole (see Figure 3).

The CSD is now calibrated to signal current flows above normal load amperes.

Output Status:

- Normal: Output Open
- Alarm: Output Closed

## Accessories

See Table 1 for accessories.

**Table 1: CR-01200-0 and CR-02400-0 Command Relays**

Product Code	Product Description
<b>CR-01200-0</b>	12 VAC/VDC Single-Pole, Single-Throw (SPST), Normally Open (N.O.) Relay
<b>CR-02400-0</b>	24 VAC/VDC Single-Pole, Single-Throw (SPST), N.O. Relay

## Repair Information

If the CSD Series Current Device fails to operate within its specifications, replace the unit. For a replacement CSD, contact the nearest Johnson Controls® representative.

## Technical Specifications

### Split Core Models CSD-CF0J1-1 and CSD-CA1G1-1

Product Code	CSD-CF0J1-1	CSD-CA1G1-1
Amperage Range	1.5–200 A	1.25–135 A
Switch Setpoint	Fixed	Adjustable
Output Relay	SPST, N.O., 10 A at 260 VAC, 5 A at 30 VDC	
Actuation Coil	20–30 VAC/VDC, 40–85 mA Maximum	
Switch LED Indication	No	Yes
Relay LED Indication	Yes	
Trip Setpoint Value	1.5 A	1.25–135 A
Current Switching Mode	Under Current Sensing	Over/Under Current Sensing
Sensor Supply Voltage	Induced from power conductor cable.	
Wire Size	2.1–0.6 mm (12–22 AWG) Diameter Recommended	
Status Output	Switch Normally Open.	
Switch Load Capacity	1 A at 30 VAC/42 VDC Maximum	
Isolation Voltage	600 VAC rms	
Temperature Range	-15 to 60°C (5 to 140°F)	
Frequency Range	50/60 Hz	
Humidity Range	0–95% Noncondensing	
Screw Torque	0.5 N·m (4 lb·in.)	
Dimension	69 x 65 x 44 mm (2-23/32 x 2-9/16 x 1-3/4 in.)	
Aperture (Sensing Hole) Size	18 x 20 mm Diameter (0.72 x 0.78 in. Diameter)	
<b>Compliance</b>  	<b>United States</b>	UL Listed, File E310692, CCN NRNT, Under UL 508, Industrial Control Equipment
	<b>Canada</b>	UL Listed, File E310692, CCN NRNT7, Under CAN/CSA C22.2 No. 14-M91 Industrial Control Equipment
	<b>Europe</b>	CE Mark – Johnson Controls, Inc. declares that this product is in compliance with the essential requirements and other relevant provisions of the EMC Directive 2004/108/EC and the Low Voltage Directive 2006/95/EC.
Shipping Weight	0.16 kg (0.35 lb)	

The performance specifications are nominal and conform to acceptable industry standards. For application of conditions beyond these specifications, consult the local Johnson Controls office. Johnson Controls, Inc. shall not be liable for damages resulting from misapplication or misuse of its products.



**Building Efficiency**

507 E. Michigan Street, Milwaukee, WI 53202

Metasys® and Johnson Controls® are registered trademarks of Johnson Controls, Inc. All other marks herein are the marks of their respective owners. © 2014 Johnson Controls, Inc.