
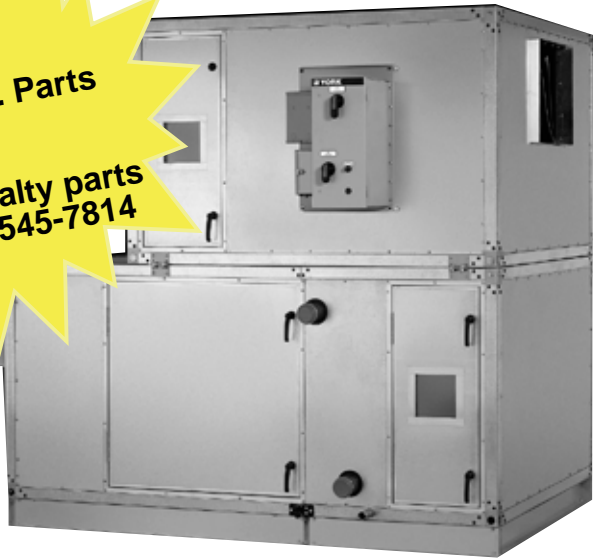


| | | |
|---|---|------------------------|
|  BY JOHNSON CONTROLS | YORK SOLUTION AIR HANDLING UNITS | |
| INSTALLATION, OPERATION & MAINTENANCE | Supersedes 102.20-NOM1 (105) | Form 102.20-NOM1 (909) |

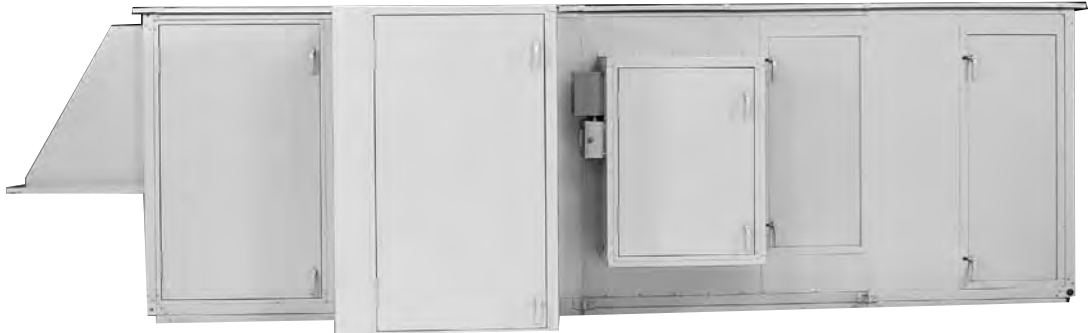
**YORK SOLUTION INDOOR AND OUTDOOR MODELS
27X27 THROUGH 132X138**

Renewal Parts
 Form 102.20-RP1
 With P/N contact Balt. Parts
 (800) 932-1701
 Manufactured or specialty parts
 contact Airside (800) 545-7814



LD09624

INDOOR UNIT



LD09688

OUTDOOR UNIT

IMPORTANT!

READ BEFORE PROCEEDING!

GENERAL SAFETY GUIDELINES

This equipment is a relatively complicated apparatus. During installation, operation, maintenance or service, individuals may be exposed to certain components or conditions including, but not limited to: refrigerants, oils, and materials under pressure, rotating components, and both high and low voltage. Each of these items has the potential, if misused or handled improperly, to cause bodily injury or death. It is the obligation and responsibility of operating/service personnel to identify and recognize these inherent hazards, protect themselves, and proceed safely in completing their tasks. Failure to comply with any of these requirements could result in serious damage to the equipment and the property in which it is situated, as well as severe personal injury or death to themselves and people at the site.

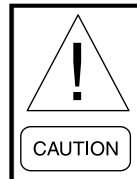
This document is intended for use by owner-authorized operating/service personnel. It is expected that this individual possesses independent training that will enable them to perform their assigned tasks properly and safely. It is essential that, prior to performing any task on this equipment, this individual shall have read and understood this document and any referenced materials. This individual shall also be familiar with and comply with all applicable governmental standards and regulations pertaining to the task in question.

SAFETY SYMBOLS

The following symbols are used in this document to alert the reader to areas of concern:



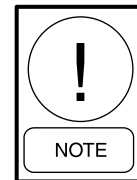
DANGER indicates an imminently hazardous situation, which if not avoided, will result in death or serious injury.



CAUTION identifies a hazard which could lead to damage to the machine, damage to other equipment and/or environmental pollution. Usually an instruction will be given, together with a brief explanation.



WARNING indicates a potentially hazardous situation, which if not avoided, could result in death or serious injury.



NOTE is used to highlight additional information that may be helpful to you.



Consider for IAQ compliance per ASHRAE STANDARD 62-2001



External wiring, unless specified as an optional connection in the manufacturer's product line, is NOT to be connected inside the control panel cabinet. Devices such as relays, switches, transducers and controls may NOT be installed inside the control panel. NO external wiring is allowed to run through the control panel. All wiring must be in accordance with Johnson Controls published specifications and must be performed ONLY by qualified Johnson Controls personnel. Johnson Controls will not be responsible for damages/problems resulting from improper connections to the controls or application of improper control signals. Failure to follow this will void the manufacturer's warranty and cause serious damage to property or injury to persons.

***NOTICE TO CUSTOMER/CONTRACTOR
PROTECT YOUR WARRANTY PRIOR TO STARTUP.***

- Read and follow the Installation & Start-up Instructions provided with this equipment.
- Storage of this equipment ***MUST*** be on a flat surface and protected from the weather.
- Protect this equipment from damage, construction dirt, debris and water.

DO NOT OPERATE DOORS WHEN UNIT IS NOT ON A FLAT SURFACE.

- Isolate this equipment from pressure testing of water, steam, gas and air piping.
- Do not test, clean and flush piping through coils in this equipment.
- Isolate this equipment from temporary building power.
- Contact local Johnson Controls Service for purchase of Startup Service with two weeks advance notice. Provide current job site contact.
- To perform a careful and thorough startup, verify the following:
 - Reliable power will be available for startup.
 - Ductwork is complete.

- Controls are complete.
- Shipping splits completely re-assembled, sealed and wired.
- Filters are installed and secured.
- All shipping materials have been removed.

METAL TAB USED TO SECURE DOOR IS A SAFETY DEVICE. DO NOT DISCARD IT.

- Start-up will be performed according to that outlined in Section 3 of the Installation and Start-up Instructions provided.
- Temporary use of air handler requires startup performed according to that outlined in Section 3 of the Installation and Start-up Instructions provided.
- A qualified startup technician must complete the “***AIR HANDLING UNITS START-UP CHECK LIST***” Form 100.00-CL1 and file a copy at the local YORK Service Office. ► This form is provided in the information package with each air handler.
- Rotate fans every four (4) weeks beginning upon arrival.

CHANGEABILITY OF THIS DOCUMENT

In complying with Johnson Controls policy for continuous product improvement, the information contained in this document is subject to change without notice. While Johnson Controls makes no commitment to update or provide current information automatically to the manual owner, that information, if applicable, can be obtained by contacting the nearest Johnson Controls Service office.

It is the responsibility of operating/service personnel to verify the applicability of these documents to the equipment in question. If there is any question in the mind of operating/service personnel as to the applicability of these documents, then prior to working on the equipment, they should verify with the owner whether the equipment has been modified and if current literature is available.

TABLE OF CONTENTS

| | |
|--|-----|
| GENERAL SAFETY GUIDELINES..... | 2 |
| CHANGEABILITY OF THIS DOCUMENT | 3 |
| TABLE OF CONTENTS | 4 |
| LIST OF FIGURES..... | 16 |
| LIST OF TABLES..... | 25 |
| SERVICE TASK REFERENCE | 26 |
| INTRODUCTION..... | 29 |
| GENERAL..... | 29 |
| TYPICAL YORK SOLUTION OPERATION IN “HVAC” SYSTEM..... | 29 |
| VENTILATION SYSTEM..... | 29 |
| ECONOMIZER SYSTEM - TYPICAL | 30 |
| HEATING OPERATION | 30 |
| COOLING OPERATION | 30 |
| HAND IDENTIFICATION | 30 |
| SEGMENT IDENTIFICATION..... | 31 |
| UNIT IDENTIFICATION | 33 |
| UNIT ID LABEL | 33 |
| SKID ID LABEL..... | 33 |
| SEGMENT IDENTIFICATION BOX..... | 33 |
| FILTER ID LABEL | 34 |
| LOOSE COMPONENT ID LABEL | 34 |
| DIRECTION OF AIRFLOW..... | 34 |
| 1.0 PRE-INSTALLATION | 1-1 |
| RECEIVING | 1-1 |
| RIGGING OF INDOOR AND OUTDOOR UNITS | 1-1 |
| OFF-LOADING | 1-2 |
| CRANE AND SPREADER BARS..... | 1-2 |
| FORK LIFT | 1-2 |
| COME-A-LONGS OR POWER PULL | 1-2 |
| SHACKLES | 1-3 |
| INSPECTION | 1-4 |
| CHECK FOR DAMAGE..... | 1-4 |
| RECEIVER RESPONSIBILITY..... | 1-4 |
| INDOOR UNITS..... | 1-4 |
| OUTDOOR UNITS..... | 1-4 |
| CHECKING FOR NON MOUNTED PARTS | 1-4 |
| STORAGE | 1-4 |
| SHORT-TERM STORAGE..... | 1-4 |
| LONG-TERM STORAGE..... | 1-5 |
| PREVENTIVE MAINTENANCE PRIOR TO LONG TERM STORAGE..... | 1-5 |
| PERIODIC FAN CHECK..... | 1-5 |

TABLE OF CONTENTS (CONT.)

| | |
|--|-------------|
| 2.0 INSTALLATION..... | 2-1 |
| SITE PREPARATION | 2-1 |
| OUTDOOR UNITS (SITE PREP)..... | 2-1 |
| MOUNTING | 2-2 |
| CURB | 2-2 |
| Curb Assembly & Installation Instructions | 2-3 |
| STEEL FRAME | 2-3 |
| INDOOR UNITS (SITE PREP)..... | 2-5 |
| CLEARANCE | 2-5 |
| MOUNTING | 2-5 |
| FLOOR | 2-5 |
| HOUSEKEEPING PAD | 2-5 |
| CEILING SUSPENDED UNITS..... | 2-6 |
| General Requirements | 2-6 |
| Structure Positioned Perpendicular to Airflow..... | 2-6 |
| Structure Positioned In the Direction of Airflow | 2-6 |
| UNIT INSTALLATION..... | 2-7 |
| TOOLS NEEDED..... | 2-7 |
| SHIP LOOSE PARTS | 2-8 |
| ASSEMBLY OF OUTDOOR UNIT..... | 2-13 |
| INSTALLING SINGLE PIECE OUTDOOR UNIT..... | 2-13 |
| INSTALLING MULTIPLE PIECE OUTDOOR UNIT | 2-13 |
| ASSEMBLY OF INDOOR UNIT..... | 2-17 |
| INSTALLING MULTIPLE PIECE INDOOR UNIT | 2-17 |
| INSTALLATION OF TIERED UNIT..... | 2-21 |
| ASSEMBLY OF END CHANNEL SHIPPING SPLIT | 2-23 |
| HOOD INSTALLATION WITH OPTIONAL MIST ELIMINATORS..... | 2-24 |
| OUTDOOR AIR TEMPERATURE AND/OR HUMIDITY SENSORS | 2-24 |
| ACTUATOR INSTALLATION | 2-25 |
| INSTALLATION OF MULTIZONE (MZ) DAMPERS..... | 2-26 |
| DAMPER INSTALLATION..... | 2-26 |
| ACTUATOR INSTALLATION MULTIZONE (MZ) - FIELD SUPPLIED | 2-27 |
| INERTIA FAN BASE FILL INSTRUCTION | 2-27 |
| HUMIDIFIERS..... | 2-27 |
| UVC EMITTER LIGHTS | 2-28 |
| AIR MEASURING DEVICE CONNECTIONS (WHEN PROVIDED)..... | 2-29 |
| AIR MEASURING AT THE FAN INLETS | 2-29 |
| AIR MEASURING AT UNIT INLETS | 2-29 |
| PIPE CHASE INSTALLATION | 2-30 |
| TOOLS REQUIRED..... | 2-30 |
| MATERIALS REQUIRED | 2-30 |
| PROCEDURE | 2-30 |
| CONDENSATE DRAIN ARRANGEMENT | 2-35 |

TABLE OF CONTENTS (CONT.)

| | |
|---|-------------|
| ELECTRICAL - GENERAL | 2-36 |
| POWER CONNECTIONS | 2-37 |
| SINGLE POINT POWER | 2-37 |
| MOTORS FOR SUPPLY FAN, RETURN FAN, EXHAUST FAN | 2-37 |
| ENERGY RECOVERY WHEEL OPTION | 2-37 |
| GAS HEAT OPTION | 2-38 |
| ELECTRIC HEAT OPTION | 2-39 |
| AVAILABLE POWER OPTIONS | 2-39 |
| ELECTRIC HEAT DISCONNECT SWITCH OPTIONS | 2-39 |
| AVAILABLE CONTROL OPTIONS | 2-40 |
| INSTALLATION | 2-40 |
| HUMIDIFIER OPTION (ELECTRIC) | 2-43 |
| HUMIDIFIER OPTION | 2-43 |
| PIPING CONNECTIONS | 2-44 |
| COIL PIPING | 2-45 |
| STAGGERED COILS | 2-45 |
| WATER | 2-46 |
| WATER COILS - HOT WATER & CHILLED WATER | 2-46 |
| HOT AND CHILLED WATER COIL PERFORMANCE | 2-46 |
| WATER TREATMENT | 2-48 |
| Freeze Protection | 2-48 |
| STEAM | 2-48 |
| STEAM COILS | 2-48 |
| STEAM DISTRIBUTING COILS | 2-48 |
| STEAM CONTROL | 2-48 |
| STEAM TRAPS | 2-49 |
| VIFB & IFB | 2-50 |
| Shipping Bolts (VIFB Only) | 2-51 |
| Piping Suggestions (VIFB & IFB) | 2-51 |
| Flexible Connectors (VIFB Only) | 2-51 |
| Freezing Conditions | 2-51 |
| REFRIGERATION | 2-54 |
| DIRECT EXPANSION COILS (DX) | 2-54 |
| DX COIL TYPES | 2-55 |
| Interlaced | 2-55 |
| Row Split | 2-55 |
| Face Split | 2-55 |
| COMBINED COIL TYPES | 2-55 |
| DX COIL CIRCUITING | 2-55 |
| DX COIL CIRCUITING AND STAGING | 2-57 |
| THERMOSTATIC EXPANSION VALVES (TXV) | 2-59 |

TABLE OF CONTENTS (CONT.)

| | |
|---|------|
| HOT GAS BYPASS | 2-59 |
| MAINTAINING ADEQUATE AIRFLOW | 2-59 |
| VAV SYSTEMS..... | 2-59 |
| DRAINS AND TRAPS..... | 2-61 |
| CONDENSATE DRAIN PIPING | 2-61 |
| CONDENSATE DRAIN TRAP..... | 2-61 |
| ELEVATING UNIT FOR GRAVITY FLOOR DRAIN CONNECTIONS | 2-62 |
| DUCT CONNECTIONS | 2-62 |
| DUCT CONNECTION GUIDELINES..... | 2-62 |
| SOUND AND VIBRATION TRANSMISSION | 2-64 |
| FRONT AND REAR DISCHARGE OUTDOOR UNIT DUCT INSTALLATION..... | 2-64 |
| AIR FILTERS | 2-65 |
| FILTER TYPES..... | 2-65 |
| MAINTENANCE AND REPLACEMENT..... | 2-65 |
| FILTER LATCHES | 2-66 |
| INSTALLATION OF 2" PERFECTPLEAT, PREMIUM OR PREMIUM HM..... | 2-68 |
| INSTALLATION OF 4" AMAIR 300X PLEATED FILTER..... | 2-69 |
| INSTALLATION OF SH SINGLE HEADERED FILTERS | 2-70 |
| INSTALLATION OF A 2" PREFILTER IN COMBINATION WITH A SINGLE HEADER FINAL FILTER | 2-70 |
| INSTALLATION OF A VARICEL DH DOUBLE HEADERED FILTER..... | 2-71 |
| INSTALLATION OF A 2" & 4" PREFILTER IN COMBINATION WITH A DOUBLE HEADER FINAL FILTER | 2-72 |
| HEPA FILTERS..... | 2-74 |
| WELDED BEVEL SEAL FRAME | 2-74 |
| Extruded Aluminum Frames for Gasketed HEPA Filter Installations..... | 2-74 |
| Two Stage Gasket Compression Prevents Leakage..... | 2-74 |
| VISUAL CONTROL FILTER CLAMPS..... | 2-74 |
| HEPA Filter Applications..... | 2-74 |
| Easy Clamp Installation | 2-74 |
| 3.0 STARTUP..... | 3-1 |
| PRE START-UP | 3-2 |
| PRE START UP FAN ASSEMBLY INSPECTION | 3-3 |
| MOTORS - ODP VS. TEFC | 3-3 |
| ISOLATORS..... | 3-4 |
| START-UP | 3-5 |
| CHECK OPERATION OF FANS..... | 3-5 |
| CHECK OPERATION OF DAMPERS | 3-5 |
| AIRFLOW CONTROL DAMPERS | 3-5 |
| TYPICAL ACTUATORS LOCATIONS..... | 3-6 |

TABLE OF CONTENTS (CONT.)

| | |
|---|------|
| BASIC ACTUATORS INSTALLATION..... | 3-6 |
| DAMPER BLADE ORIENTATION..... | 3-6 |
| Return Air and Mixing Dampers with Power Off..... | 3-6 |
| Outside Air and Exhaust Air Dampers..... | 3-6 |
| ENERGIZE FAN MOTOR(S) | 3-7 |
| VARIABLE SPEED DRIVE (VSD)..... | 3-7 |
| SET UP OF A NON- FACTORY MOUNTED VFD | 3-7 |
| CHECK DOORS AND LATCHES FOR PROPER ADJUSTMENT..... | 3-8 |
| SHEAVES | 3-8 |
| ENERGY RECOVERY WHEEL | 3-9 |
| UNIT CONFIGURATION | 3-9 |
| START-UP PROCEDURE FOR ENERGY RECOVERY WHEEL..... | 3-9 |
| INDIRECT FIRED GAS HEAT START UP - ECLIPSE GAS BURNER START UP 10:1 - 25:1 TURNDOWN & POWERFLAME GAS BURNER START UP 3:1 - 10:1 TURNDOWN.... | 3-11 |
| INTRODUCTION | 3-11 |
| IDENTIFY THE UNIT TYPE..... | 3-11 |
| PRELIMINARY COORDINATION | 3-12 |
| TOOLS RECOMMENDED..... | 3-12 |
| AIR HANDLER PRE START CHECKS..... | 3-12 |
| BURNER PRE START CHECKS | 3-12 |
| BURNER START-UP PROCEDURE | 3-14 |
| CONDENSATE DRAIN ARRANGEMENT | 3-15 |
| ELECTRIC HEAT STARTUP | 3-25 |
| AIRFLOW REQUIREMENTS | 3-25 |
| 4.0 OPERATION & MAINTENANCE | 4-1 |
| OPERATION..... | 4-1 |
| TEST AND BALANCE..... | 4-1 |
| AIR BALANCE | 4-1 |
| DYNAMIC BALANCE..... | 4-1 |
| TEMPERATURE LIMITS | 4-3 |
| STATIC PRESSURE LIMITS | 4-3 |
| MOTORS | 4-3 |
| BELTS..... | 4-3 |
| SHEAVES | 4-3 |
| MAINTENANCE | 4-3 |
| INTRODUCTION..... | 4-3 |
| AIR HANDLER CABINET | 4-3 |
| HARDWARE CHECK | 4-3 |
| GASKETS..... | 4-3 |
| PANELS..... | 4-3 |
| HOODS AND LOUVERS..... | 4-4 |
| BIRD SCREENS..... | 4-4 |

TABLE OF CONTENTS (CONT.)

| | |
|--|------|
| MIST ELIMINATORS | 4-4 |
| CLEANING/REPLACEMENT | 4-4 |
| FAN SEGMENT (SUPPLY, RETURN, EXHAUST) - FAN ASSEMBLY | 4-4 |
| ADJUSTABLE MOTOR BASE OPERATION (STANDARD) | 4-5 |
| ADJUSTABLE MOTOR BASE OPERATION..... | 4-5 |
| (TOP MOUNT) | 4-5 |
| BELTS | 4-7 |
| SHEAVES ALIGNMENT | 4-7 |
| ALIGNMENT USING A STRAIGHTEDGE | 4-8 |
| ALIGNMENT USING A STRING | 4-8 |
| LUBRICATION | 4-10 |
| VERIFY TYPES OF BEARINGS | 4-10 |
| Sealed (not to be re-lubricated in the field)..... | 4-10 |
| Standard Pillow Block..... | 4-10 |
| Split Pillow Block..... | 4-10 |
| FAN BEARING LUBRICATION | 4-11 |
| CHECK CONDITION OF EXTENDED LUBRICATION LINES WHEN PRESENT | 4-11 |
| RECOMMENDED LUBRICANT FOR FAN BEARINGS | 4-11 |
| PROPER INTERVAL AND QUANTITY | 4-11 |
| FAN SEGMENT-FAN MOTOR..... | 4-12 |
| MOTOR CONDITION (VISUAL)..... | 4-12 |
| ELECTRICAL CHECKS | 4-12 |
| LUBRICATION | 4-13 |
| MOTOR BEARING LUBRICANT | 4-13 |
| FILTER SEGMENTS (PRE FILTER AND FINAL FILTER) | 4-15 |
| FILTER TYPES | 4-15 |
| MAINTENANCE AND REPLACEMENT | 4-15 |
| INSERTING FILTERS INTO SIDE LOAD FILTER TRACKS FOR ANGLE AND FLAT FILTER SEGMENTS..... | 4-15 |
| INSTALLATION OF 2" PERFECTPLEAT, PREMIUM OR PREMIUM HM..... | 4-18 |
| INSTALLATION OF 4" AMAIR 300X PLEATED FILTER | 4-19 |
| INSTALLATION OF SH SINGLE HEADERED FILTERS..... | 4-20 |
| INSTALLATION OF A 2" PREFILTER IN COMBINATION WITH A SINGLE HEADER FINAL FILTER | 4-21 |
| INSTALLATION OF A VARICEL DH DOUBLE HEADERED FILTER | 4-22 |
| INSTALLATION OF A 2" & 4" PREFILTER IN COMBINATION WITH A DOUBLE HEADER FINAL FILTER..... | 4-23 |
| HEPA FILTERS..... | 4-26 |
| WELDED BEVEL SEAL FRAME | 4-26 |
| EXTRUDED ALUMINUM FRAMES FOR GASKETED HEPA FILTER INSTALLATIONS..... | 4-26 |
| TWO STAGE GASKET COMPRESSION PREVENTS LEAKAGE | 4-26 |

TABLE OF CONTENTS (CONT.)

| | |
|---|------|
| VISUAL CONTROL FILTER CLAMPS..... | 4-26 |
| HEPA FILTER APPLICATIONS | 4-26 |
| EASY CLAMP INSTALLATION | 4-26 |
| ECONOMIZER SEGMENT (DAMPERS)..... | 4-28 |
| CLEANING OF DAMPERS | 4-28 |
| HARDWARE CHECK..... | 4-28 |
| COIL SEGMENT..... | 4-28 |
| COIL CLEANING PROCEDURE..... | 4-28 |
| SUGGESTED TOOLS, EQUIPMENT & MATERIALS LIST | 4-28 |
| CLEANING PROCEDURE | 4-28 |
| CONDENSATE DRAIN PAN, TRAP AND DRAIN LINE CLEANING PROCEDURE..... | 4-29 |
| TOOLS AND MATERIALS | 4-29 |
| CLEANING PROCEDURE | 4-30 |
| FREEZE PROTECTION | 4-30 |
| WINTERIZING DRAIN TRAPS..... | 4-30 |
| ENERGY RECOVERY WHEEL | 4-31 |
| TOOLS | 4-31 |
| MATERIALS | 4-31 |
| CLEANING | 4-31 |
| WHEEL | 4-31 |
| ADJUSTMENT OF AIR SEALS | 4-31 |
| WHEEL DRIVE COMPONENTS | 4-32 |
| 5.0 SERVICE AND REPAIR..... | 5-1 |
| SERVICE TOOLS AND EQUIPMENT..... | 5-1 |
| SERVICE INFORMATION | 5-2 |
| TROUBLESHOOTING | 5-2 |
| PITOT TUBE..... | 5-3 |
| INCLINED MANOMETER..... | 5-3 |
| MINIHELIC FILTER GAUGE | 5-3 |
| “U” TUBE MANOMETER..... | 5-4 |
| DUCT PRESSURES AND HOW THEY WORK..... | 5-5 |
| VELOCITY | 5-5 |
| STATIC PRESSURE..... | 5-5 |
| TOTAL PRESSURE..... | 5-5 |
| TROUBLE SHOOTING TIPS..... | 5-6 |
| REQUESTING ASSISTANCE | 5-6 |
| COMPONENT REPLACEMENT, ADJUSTMENT & REPAIR | 5-6 |
| FAN REPLACEMENT & ADJUSTMENT..... | 5-6 |
| TOOLS REQUIRED..... | 5-6 |
| MATERIALS REQUIRED | 5-6 |
| PROCEDURE..... | 5-6 |

TABLE OF CONTENTS (CONT.)

| | |
|--|-------------|
| FAN REPAIR..... | 5-7 |
| TOOLS REQUIRED..... | 5-7 |
| MATERIALS REQUIRED | 5-7 |
| FORWARD CURVED FAN WHEEL REPLACEMENT..... | 5-7 |
| AIRFOIL FAN WHEEL REPLACEMENT | 5-8 |
| FAN BEARING REPLACEMENT | 5-9 |
| SEALED BEARINGS | 5-9 |
| TOOLS REQUIRED | 5-9 |
| MATERIAL REQUIRED..... | 5-9 |
| PROCEDURE..... | 5-9 |
| STANDARD PILLOW BLOCK BEARINGS | 5-10 |
| TOOLS REQUIRED | 5-10 |
| MATERIAL REQUIRED..... | 5-10 |
| ABOUT THIS DEVICE | 5-10 |
| PROCEDURE..... | 5-11 |
| PILLOW BLOCK BEARINGS WITH ECCENTRIC LOCKING COLLAR | 5-12 |
| TOOLS REQUIRED | 5-12 |
| MATERIAL REQUIRED..... | 5-12 |
| ABOUT THIS DEVICE | 5-12 |
| PROCEDURE..... | 5-12 |
| SPLIT PILLOW BLOCK BEARINGS..... | 5-14 |
| TOOLS REQUIRED | 5-14 |
| MATERIAL REQUIRED..... | 5-14 |
| ABOUT THIS DEVICE | 5-14 |
| PROCEDURE..... | 5-15 |
| SHEAVE REPLACEMENT AND ADJUSTMENT | 5-18 |
| FIXED PITCH SHEAVES | 5-18 |
| TOOLS REQUIRED | 5-18 |
| MATERIAL REQUIRED..... | 5-18 |
| SHEAVE REMOVAL..... | 5-18 |
| SHEAVE INSTALLATION | 5-18 |
| Standard Mounting..... | 5-18 |
| Reverse Mounting | 5-19 |
| SHEAVE ADJUSTMENT..... | 5-20 |
| ADJUSTABLE PITCH SHEAVES | 5-20 |
| T.B. WOODS MODEL JVS..... | 5-20 |
| Tools Required..... | 5-20 |
| Material Required | 5-20 |
| Sheave Removal | 5-20 |
| Sheave Installation | 5-20 |
| Sheave Adjustment | 5-21 |

TABLE OF CONTENTS (CONT.)

| | |
|---|------|
| T.B. WOODS MODEL FHP..... | 5-21 |
| Tools Required..... | 5-21 |
| Material Required | 5-21 |
| Sheave Removal | 5-21 |
| Sheave Installation | 5-22 |
| Sheave Adjustment | 5-22 |
| MOTOR REPLACEMENT | 5-23 |
| FAN MOTOR | 5-23 |
| TOOLS REQUIRED | 5-23 |
| MATERIAL REQUIRED..... | 5-23 |
| PROCEDURE..... | 5-23 |
| MOTOR REPAIR | 5-24 |
| TOOLS REQUIRED..... | 5-24 |
| MATERIALS REQUIRED | 5-24 |
| COIL REPLACEMENT | 5-25 |
| TOOLS REQUIRED..... | 5-25 |
| MATERIALS REQUIRED | 5-26 |
| PROCEDURE..... | 5-26 |
| DOOR REPLACEMENT..... | 5-28 |
| TOOLS REQUIRED..... | 5-28 |
| MATERIALS REQUIRED | 5-28 |
| PROCEDURE..... | 5-28 |
| DOOR GASKET REPLACEMENT | 5-29 |
| TOOLS REQUIRED..... | 5-29 |
| MATERIALS REQUIRED | 5-29 |
| PROCEDURE..... | 5-29 |
| REMOVE OLD GASKET..... | 5-29 |
| REMOVE SEALANT | 5-29 |
| INSTALL NEW MITERED GASKET (BEFORE JAN 2006)..... | 5-29 |
| INSTALL NEW GASKET ON DOOR PRODUCED JAN 2006 THROUGH OCTOBER 2008) .. | 5-34 |
| INSTALL NEW GASKET ON DOOR PRODUCED AFTER OCT 2008 | 5-40 |
| PREPARATION..... | 5-40 |
| GASKET INSTALLATION..... | 5-40 |
| Examples of a Good Gasket Corner | 5-41 |
| Examples of Unacceptable Corners | 5-42 |
| Examples of Unacceptable Gasket Fit | 5-42 |
| Examples of Good Finished Joints | 5-44 |
| Examples of Unacceptable Joints | 5-44 |
| SPLICING..... | 5-45 |
| DOOR HANDLE/LATCH REPLACEMENT AND ADJUSTMENT | 5-46 |
| STANDARD OUT SWING DOOR | 5-46 |
| TOOLS REQUIRED | 5-46 |
| MATERIALS REQUIRED | 5-46 |
| PROCEDURE..... | 5-46 |

TABLE OF CONTENTS (CONT.)

| | |
|---|------|
| STANDARD OUT SWING DOOR WITH MULTI-POINT LATCH | 5-46 |
| TOOLS REQUIRED | 5-46 |
| MATERIALS REQUIRED | 5-46 |
| PROCEDURE | 5-46 |
| STANDARD IN SWING DOOR | 5-48 |
| TOOLS REQUIRED | 5-48 |
| MATERIALS REQUIRED | 5-48 |
| PROCEDURE | 5-48 |
| STANDARD IN SWING DOOR WITH MULTI-POINT LATCH | 5-48 |
| TOOLS REQUIRED | 5-48 |
| MATERIALS REQUIRED | 5-48 |
| PROCEDURE | 5-48 |
| ISOLATOR SPRING REPLACEMENT AND ADJUSTMENT | 5-49 |
| TOOLS REQUIRED | 5-49 |
| MATERIAL REQUIRED | 5-49 |
| PROCEDURE | 5-49 |
| ISOLATOR SPRING REPLACEMENT | 5-49 |
| ISOLATOR ADJUSTMENT (LEVEL WITH PROPER CLEARANCES) | 5-49 |
| THRUST RESTRAINT REPLACEMENT AND ADJUSTMENT | 5-50 |
| REAR DISCHARGE ORIENTATION | 5-50 |
| TOOLS REQUIRED | 5-50 |
| MATERIAL REQUIRED | 5-50 |
| PROCEDURE | 5-50 |
| THRUST RESTRAINT REPLACEMENT | 5-50 |
| THRUST RESTRAINT ADJUSTMENT | 5-51 |
| FIELD CUT OPENINGS FOR DUCTS, DAMPERS AND SPECIAL ACCESS FOR YORK SOLUTION DOUBLE WALL 2" PANELS | 5-52 |
| TOOLS REQUIRED | 5-52 |
| MATERIAL REQUIRED | 5-52 |
| PROCEDURE | 5-52 |
| PANEL REPLACEMENT | 5-53 |
| TOOLS REQUIRED | 5-53 |
| MATERIAL REQUIRED | 5-53 |
| PROCEDURE | 5-54 |
| PRESSURE TAPE REMOVAL AND INSTALLATION INSTRUCTIONS ON XTO ROOF PANELS | 5-54 |
| TOOLS REQUIRED | 5-54 |
| MATERIAL REQUIRED | 5-54 |
| SEAM SEALING STRIP ORDERING INFORMATION | 5-55 |
| PROCEDURE | 5-55 |
| FIELD PENETRATIONS FOR PIPING & ELECTRICAL CONNECTIONS | 5-56 |
| TOOLS REQUIRED | 5-56 |
| MATERIAL REQUIRED | 5-56 |
| PROCEDURE | 5-56 |

TABLE OF CONTENTS (CONT.)

| | |
|--|-------------|
| FIELD MODIFICATION TO ADD DOORS..... | 5-58 |
| TOOLS REQUIRED..... | 5-58 |
| MATERIAL REQUIRED..... | 5-58 |
| PROCEDURE..... | 5-58 |
| LIGHT BULB REPLACEMENT | 5-60 |
| TOOLS REQUIRED..... | 5-60 |
| MATERIALS REQUIRED | 5-60 |
| PROCEDURE..... | 5-60 |
| LIGHT ASSEMBLY REPLACEMENT..... | 5-60 |
| TOOLS REQUIRED..... | 5-60 |
| MATERIALS REQUIRED | 5-60 |
| PROCEDURE..... | 5-60 |
| FILTER GAGE REPLACEMENT..... | 5-61 |
| TOOLS REQUIRED..... | 5-61 |
| MATERIALS REQUIRED | 5-61 |
| PROCEDURE..... | 5-61 |
| FILTER GAGE INSTALLATION (FIELD CUT)..... | 5-62 |
| TOOLS REQUIRED..... | 5-62 |
| MATERIALS REQUIRED | 5-62 |
| INSTALLATION CONSIDERATIONS..... | 5-62 |
| PROCEDURE..... | 5-62 |
| ENERGY RECOVERY WHEEL | 5-64 |
| TOOLS REQUIRED..... | 5-64 |
| MATERIALS REQUIRED | 5-64 |
| REPLACING WHEEL SEGMENTS..... | 5-64 |
| REMOVAL OF SEGMENTS..... | 5-64 |
| INSTALLATION OF SEGMENTS..... | 5-65 |
| WHEEL DRIVE MOTOR & PULLEY REPLACEMENT..... | 5-65 |
| BELT REPLACEMENT | 5-66 |
| INSTALLING DOOR SAFETY CHAIN..... | 5-70 |
| TOOLS REQUIRED..... | 5-70 |
| MATERIAL REQUIRED..... | 5-70 |
| PROCEDURE..... | 5-70 |
| DIRECT COUPLED DAMPER ACTUATOR REPLACEMENT AND ADJUSTMENT | 5-71 |
| TOOLS REQUIRED..... | 5-71 |
| MATERIALS REQUIRED | 5-71 |
| PROCEDURE..... | 5-71 |
| DAMPER BLADE ORIENTATION..... | 5-71 |
| Return Air and Mixing Dampers:..... | 5-71 |
| Outside Air and Exhaust Air Dampers: | 5-71 |
| ACTUATOR REMOVAL | 5-72 |
| ACTUATOR REPLACEMENT..... | 5-72 |

TABLE OF CONTENTS (CONT.)

| | |
|--|------|
| MIXING DAMPER WALL REPAIR | 5-72 |
| TOOLS REQUIRED..... | 5-72 |
| MATERIALS REQUIRED | 5-72 |
| PROCEDURE..... | 5-73 |
| POWER FLAME / ECLIPSE INDUCER FAN GASKET REPLACEMENT | 5-75 |
| TOOLS REQUIRED..... | 5-75 |
| MATERIALS REQUIRED | 5-75 |
| PROCEDURE..... | 5-75 |
| 6.0 WIRING SCHEMATICS..... | 6-1 |

LIST OF FIGURES

| | |
|---|------|
| FIG. 1 – CUTAWAY OF YORK SOLUTION SHOWING VARIOUS SEGMENTS..... | 29 |
| FIG. 2 – UNIT AND COIL HAND IDENTIFICATION..... | 30 |
| FIG. 3 – UNIT ID LABEL | 33 |
| FIG. 4 – SKID ID LABEL | 33 |
| FIG. 5 – SEGMENT ID BOX EXAMPLE | 33 |
| FIG. 6 – LOOSE COMPONENT ID LABELS | 34 |
| FIG. 7 – FILTER LABELS | 34 |
| FIG. 1-1 – RECOMMENDED LIFTING WITH FOUR LIFTING POINTS | 1-1 |
| FIG. 1-2 – RECOMMENDED LIFTING WITH MULTIPLE POINTS..... | 1-1 |
| FIG. 1-3 – TYPICAL COME-A-LONG TYPES..... | 1-2 |
| FIG. 1-4 – PROPER LIFTING WITH SHACKLE AT CORNER | 1-3 |
| FIG. 1-5 – PROPER LIFTING WITH SHACKLE AT LIFTING LUG | 1-3 |
| FIG. 1-6 – RECOMMENDED LIFTING WITH BASERAIL | 1-3 |
| FIG. 2-1 – MINIMUM SERVICE CLEARANCES..... | 2-1 |
| FIG. 2-2 – TYPICAL CURB ASSEMBLY..... | 2-4 |
| FIG. 2-3 – NO BASERAIL – HOUSEKEEPING PAD REQUIRED TO ACCOMMODATE TRAP HEIGHT | 2-5 |
| FIG. 2-4 – NO HOUSEKEEPING PAD – BASERAIL REQUIRED TO ACCOMMODATE TRAP HEIGHT | 2-5 |
| FIG. 2-5 – WITH BASERAIL AND HOUSEKEEPING PAD | 2-5 |
| FIG. 2-6 – CEILING SUSPENDED UNIT | 2-6 |
| FIG. 2-7 – TOOLS TYPICALLY USED FOR ASSEMBLY OF SHIPPING SPLITS | 2-7 |
| FIG. 2-8 – SECOND TIER TIE-DOWN FASTENER PACK P/N 386-03419-000..... | 2-8 |
| FIG. 2-9 – BOTTOM RACEWAY SHIPPING SPLIT FASTENER PACK P/N 386-03418-000 | 2-8 |
| FIG. 2-10 – BASERAIL SHIPPING SPLIT FASTENER PACK P/N 386-03417-000 | 2-8 |
| FIG. 2-11 – TOP RACEWAY SPLIT FASTENER PACK | 2-8 |
| FIG. 2-12 – PIPE CHASE, HOODS & SEAM CAPS..... | 2-9 |
| FIG. 2-13 – MISCELLANEOUS PARTS FOR OPTIONS..... | 2-10 |
| FIG. 2-14 – HARDWARE, GASKETING, CAULK, PAINT AND TAPE | 2-11 |
| FIG. 2-15 – SHIPPING SPLIT EXAMPLES..... | 2-12 |
| FIG. 2-16 – SHIPPING SPLIT EXAMPLES FOR EXPANDED CABINET | 2-12 |
| FIG. 2-17 – APPLYING GASKET | 2-14 |
| FIG. 2-18 – ELECTRICAL CONNECTIONS..... | 2-14 |
| FIG. 2-19 – REMOVE AND REPOSITION SHIPPING SPLIT ANGLE..... | 2-15 |
| FIG. 2-20 – BRINGING SECTIONS TOGETHER | 2-16 |
| FIG. 2-21 – APPLYING GASKET TO SHIPPING SPLIT..... | 2-17 |
| FIG. 2-22 – APPLYING GASKET TO DOOR FRAME WHEN AT SHIPPING SPLIT..... | 2-17 |
| FIG. 2-23 – ASSEMBLY OF END CHANNEL SHIPPING SPLIT ((EXPANDED CABINET)..... | 2-18 |
| FIG. 2-24 – REMOVE AND REPOSITION SHIPPING SPLIT ANGLE..... | 2-18 |
| FIG. 2-25 – PLACING & ANCHORING FIRST SECTION AND ATTACHING COME-A-LONGS..... | 2-19 |
| FIG. 2-26 – REMOVE LIFTING LUGS AND SAVE HARDWARE | 2-19 |
| FIG. 2-27 – ELECTRICAL CONNECTIONS..... | 2-19 |
| FIG. 2-28 – INSTALLING BOLTS AFTER PULLING UNITS TIGHT TOGETHER | 2-20 |
| FIG. 2-29 – TIERED UNIT | 2-21 |
| FIG. 2-30 – TIERED UNIT SECURED WITH BRACKETS | 2-21 |

LIST OF FIGURES (CONT.)

| | |
|---|------|
| FIG. 2-31 – APPLY GASKETS TO TOP PANEL BOTTOM TIER | 2-21 |
| FIG. 2-32 – GUIDING BRACKETS TOGETHER..... | 2-22 |
| FIG. 2-33 – ASSEMBLY OF END CHANNEL SHIPPING SPLIT | 2-23 |
| FIG. 2-34 – HOOD INSTALLATION WITH OPTIONAL MIST ELIMINATORS | 2-24 |
| FIG. 2-35 – DIRECT COUPLED ON JACKSHAFT..... | 2-25 |
| FIG. 2-36 – MZ DAMPER/ACTUATOR ASSEMBLY..... | 2-26 |
| FIG. 2-37 – DAMPER SHAFT EXTENSION KIT..... | 2-27 |
| FIG. 2-38 – V-MOD INSTALLATION | 2-28 |
| FIG. 2-39 – V-RAY INSTALLATION | 2-28 |
| FIG. 2-40 – V-FLEX INSTALLATION | 2-28 |
| FIG. 2-41 – INSTALL GASKET UNDER ROOF OVERHANG | 2-30 |
| FIG. 2-42 – APPLY GASKET TO PIPE CHASE..... | 2-31 |
| FIG. 2-43 – PIPE CHASE BASERAIL TO UNIT BASERAIL INSTALLATION | 2-31 |
| FIG. 2-44 – SCREW PIPE CHASE TOP AND BOTTOM INTERNAL FLANGES TO AIR HANDLER | 2-31 |
| FIG. 2-45 – BASERAIL CAULK APPLICATION..... | 2-32 |
| FIG. 2-46 – PIPE CHASE TO ROOF INSTALLATION..... | 2-32 |
| FIG. 2-47 – PIPE CHASE TO AIR HANDLER CAULK APPLICATION..... | 2-32 |
| FIG. 2-48 – INSTALL COVER ANGLE..... | 2-32 |
| FIG. 2-49 – PROPER POSITIONING OF COVER ANGLE WITH NOTCH ON AIR HANDLER SIDE..... | 2-33 |
| FIG. 2-50 – PROPER PATTERN FOR INSTALLING SELF-DRILLING SCREWS TO COVER ANGLE | 2-33 |
| FIG. 2-51 – BASERAIL COVER APPLICATION..... | 2-33 |
| FIG. 2-52 – GAS FURNACE FUEL VENTING SYSTEM | 2-34 |
| FIG. 2-53 – GAS FURNACE CONDENSATE DRAIN TRAP | 2-35 |
| FIG. 2-54 – TYPICAL MOTOR DATA / NAMEPLATE..... | 2-37 |
| FIG. 2-55 – TYPICAL POWER WIRING OF ENERGY RECOVERY WHEEL | 2-37 |
| FIG. 2-56 – GAS BURNER COMPONENT LOCATIONS | 2-38 |
| FIG. 2-57 – MAIN POWER AND CONTROL PANEL W/ COVER OPEN | 2-38 |
| FIG. 2-58 – TYPICAL ELECTRIC HEAT CONTROL PANEL INTERIOR WIRING AND COMPONENTS..... | 2-39 |
| FIG. 2-59 – TYPICAL FIELD CONTROL AND POWER CONNECTIONS..... | 2-39 |
| FIG. 2-60 – PRESSURE PROBE DIRECTION | 2-41 |
| FIG. 2-61 – AIRFLOW SWITCH CONNECTIONS | 2-41 |
| FIG. 2-62 – TYPICAL HUMIDIFIER PANEL LAYOUT | 2-43 |
| FIG. 2-63 – SUPPLY POWER KNOCKOUTS | 2-43 |
| FIG. 2-64 – HUMIDIFIER POINTS | 2-43 |
| FIG. 2-65 – PIPE CHASE ENCLOSURE | 2-44 |
| FIG. 2-66 – FACTORY COIL CONNECTIONS..... | 2-44 |
| FIG. 2-67 – STAGGERED COIL CONFIGURATIONS | 2-45 |
| FIG. 2-68 – CHILLED WATER COIL CONNECTIONS | 2-46 |
| FIG. 2-69 – HOT WATER PIPING - 2 WAY VALVE..... | 2-47 |
| FIG. 2-70 – HOT WATER PIPING WITH DIVERTING VALVE | 2-47 |
| FIG. 2-71 – STEAM COIL PIPING ARRANGEMENTS..... | 2-49 |
| FIG. 2-72 – INTEGRAL FACE & BYPASS COIL (HORIZONTAL; TUBES, STEAM SHOWN)..... | 2-50 |
| FIG. 2-73 – VERTICAL INTEGRAL FACE & BYPASS COIL | 2-50 |

LIST OF FIGURES (CONT.)

| | |
|---|------|
| FIG. 2-74 – HOT WATER PIPING FOR 2 ROW COIL VIFB | 2-52 |
| FIG. 2-75 – HOT WATER PIPING FOR IFB | 2-52 |
| FIG. 2-76 – STEAM PIPING FOR VIFB COIL..... | 2-53 |
| FIG. 2-77 – TYPICAL PIPING AND SUNDRIES AT THE DX COIL..... | 2-54 |
| FIG. 2-78 – DX COIL CIRCUITING TYPES | 2-55 |
| FIG. 2-79 – NON-STACKED COIL DESIGN - SQ SPECIAL | 2-56 |
| FIG. 2-80 – NON-STACKED COIL DESIGN - STANDARD | 2-56 |
| FIG. 2-81 – STACKED COIL DESIGN - STANDARD | 2-57 |
| FIG. 2-82 – STACKED COIL DESIGNS - SQ SPECIAL | 2-57 |
| FIG. 2-83 – STACKED COIL CIRCUITING | 2-57 |
| FIG. 2-84 – ONE COIL CIRCUIT PERREFRIGERANT CIRCUIT | 2-58 |
| FIG. 2-85 – TWO COIL CIRCUITS PERREFRIGERANT CIRCUIT | 2-58 |
| FIG. 2-86 – DO NOT USE THE ABOVE CONFIGURATION. | 2-58 |
| FIG. 2-87 – THREE COMPRESSOR YCUL | 2-58 |
| FIG. 2-88 – DO NOT USE THE ABOVE CONFIGURATION. | 2-58 |
| FIG. 2-89 – SIX COMPRESSOR YCUL | 2-59 |
| FIG. 2-90 – DRAIN TRAP SHOWING WATER LOCATION DURING DRAW THROUGH OPERATION STAGES | 2-61 |
| FIG. 2-91 – TRAP DETAIL FOR DRAW THROUGH APPLICATION..... | 2-61 |
| FIG. 2-92 – TRAP DETAIL FOR BLOW THROUGH APPLICATION..... | 2-61 |
| FIG. 2-93 – COMBINING DRAIN LINES..... | 2-62 |
| FIG. 2-94 – RECOMMENDED DISCHARGE DUCT ARRANGEMENT WHEN TURNS ARE REQUIRED..... | 2-62 |
| FIG. 2-95 – RECOMMENDED DISCHARGE DUCT ARRANGEMENT WHEN TURNS ARE REQUIRED..... | 2-63 |
| FIG. 2-96 – DUCT PENETRATION OF ROOF | 2-64 |
| FIG. 2-97 – ROOF TO DUCT INSTALLATION - HORIZONTAL DISCHARGE..... | 2-64 |
| FIG. 2-97A – TYPICAL FILTERS | 2-65 |
| FIG. 2-98 – FILTER LATCHES..... | 2-66 |
| FIG. 2-99 – CORRECTLY INSTALLED LATCH P/N 026-35778-000..... | 2-68 |
| FIG. 2-100 – FULLY INSTALLED FILTER | 2-68 |
| FIG. 2-101 – CORRECTLY INSTALLED LATCH P/N 026-35778-007..... | 2-69 |
| FIG. 2-102 – PLACE THE END OF THE LATCH OVER THE FILTER FRAME, SECURING THE FILTER TO THE FRAME..... | 2-69 |
| FIG. 2-103 – INSTALLED CARTRIDGE FILTER | 2-70 |
| FIG. 2-104 – INSTALL LATCH P//N 026-35778-007..... | 2-70 |
| FIG. 2-105 – INSTALLED CARTRIDGE W/PLEATS..... | 2-70 |
| FIG. 2-106 – CORRECT USE OF KNOCKOUTS | 2-71 |
| FIG. 2-107 – CORRECT LATCH/KNOCKOUT CONFIGURATION. | 2-71 |
| FIG. 2-108 – FRAME WITH 4 LATCHES INSTALLED. | 2-71 |
| FIG. 2-109 – SPRING LATCH SHOULD BE PULLED AND FASTENED IN HOLE IN THE HEADER OF THE FILTER. | 2-71 |
| FIG. 2-110 – CORRECT LATCH/KNOCKOUT CONFIGURATION. P/N 026-35778-006 | 2-72 |

LIST OF FIGURES (CONT.)

| | |
|--|------|
| FIG. 2-111 – FRAME WITH 4 LATCHES INSTALLED | 2-72 |
| FIG. 2-112 – PREFILTER LATCH AFTER INSTALLATION ONTO FILTER HEADER..... | 2-72 |
| FIG. 2-113 – POSITION PREFILTER IN FRONT OF THE FINAL FILTER. (2" W/026-36339-000 LATCH SHOWN) | 2-73 |
| FIG. 2-114 – SPRING THE END OF THE LATCH SO THAT IT FITS OVER THE EDGE OF THE PREFILTER. (4" W/026-36339-000 LATCH SHOWN) | 2-73 |
| FIG. 2-115 – COMPLETED ASSEMBLY | 2-73 |
| FIG. 2-116 – HEPA FILTER FRAME CROSS SECTION VIEW | 2-74 |
| FIG. 2-117 – VISUAL CONTROL FILTER CLAMPS..... | 2-74 |
| FIG. 2-118 – HEPA FILTER INSTALLATION | 2-75 |
| FIG. 2-119 – WELDED BEVEL SEAL FILTER INSTALLATION..... | 2-75 |
| FIG. 3-1 – TERMINATION CHART INSIDE ENCLOSURE DOOR | 3-2 |
| FIG. 3-2 – FAN AND MOTOR ISOLATOR SUPPORT FRAME | 3-3 |
| FIG. 3-3 – ODP (OPEN DRIP PROOF) | 3-3 |
| FIG. 3-4 – TEFC (TOTALLY ENCLOSED FAN COOLED)..... | 3-4 |
| FIG. 3-5 – SPRING ISOLATOR..... | 3-4 |
| FIG. 3-6 – SEISMIC SNUBBER | 3-4 |
| FIG. 3-7 – EXAMPLE OF SWEEP BALANCE RESULTS | 3-7 |
| FIG. 3-8 – TYPICAL DRIVE KIT DATA TAG | 3-8 |
| FIG. 3-9 – INDOOR UNIT - VERTICAL WHEEL | 3-9 |
| FIG. 3-10 – OUTDOOR UNIT - HORIZONTAL WHEEL..... | 3-9 |
| FIG. 3-11 – ENERGY RECOVERY WHEEL - PULLEY SIDE | 3-10 |
| FIG. 3-12 – SEGMENT RETAINER | 3-10 |
| FIG. 3-13 – DIAMETER SEAL ADJUSTMENT | 3-10 |
| FIG. 3-14 – OPEN FUSE DISCONNECTS | 3-12 |
| FIG. 3-15 – SET ID FAN DAMPER | 3-13 |
| FIG. 3-16 – CHECK MAIN GAS SUPPLY PRESSURE | 3-13 |
| FIG. 3-17 – DRAFT OVER FIRE TEST PORT | 3-14 |
| FIG. 3-18 – FLUE (STACK) COMBUSTION TEMPERATURE AND EFFICIENCY TEST PORT | 3-14 |
| FIG. 3-19 – DAMPER ACTUATOR..... | 3-15 |
| FIG. 3-20 – CONDENSATE DRAIN | 3-15 |
| FIG. 3-21 – GAS FURNACE CONDENSATE DRAIN TRAP | 3-16 |
| FIG. 3-22 – GAS FURNACE FUEL VENTING SYSTEM | 3-20 |
| FIG. 3-23 – GAS FURNACE FUEL VENTING SYSTEM | 3-21 |
| FIG. 3-24 – TYPICAL WIRING DIAGRAM | 3-22 |
| FIG. 3-25 – MINIMUM AIR VELOCITY REQUIRED FOR SAFE OPERATION | 3-25 |
| FIG. 3-26 – PRESSURE PROBE DIRECTION | 3-26 |
| FIG. 3-27 – AIRFLOW SWITCH CONNECTIONS | 3-26 |
| FIG. 4-1 – MIST ELIMINATOR REMOVAL..... | 4-4 |
| FIG. 4-2 – TYPICAL DRIVE KIT DATA TAG | 4-4 |
| FIG. 4-3 – ADJUSTABLE MOTOR BASE (STANDARD) | 4-5 |
| FIG. 4-4 – ADJUSTABLE MOTOR BASE (TOP MOUNT)..... | 4-6 |
| FIG. 4-5 – BELT TENSIONING | 4-7 |

LIST OF FIGURES (CONT.)

| | |
|---|------|
| FIG. 4-6 – BELT TENSIONING GAUGE | 4-7 |
| FIG. 4-7 – SHEAVE ALIGNMENT | 4-8 |
| FIG. 4-8 – BELT REPLACEMENT TENSIONING AND ALIGNMENT (TOP MOUNT) | 4-9 |
| FIG. 4-9 – SEALED BEARING..... | 4-10 |
| FIG. 4-10 – BEARING WITH SETSCREW TYPE LOCKING DEVICE | 4-10 |
| FIG. 4-11 – BEARING WITH ECCENTRIC CAM | 4-10 |
| FIG. 4-12 – SPLIT BEARING | 4-10 |
| FIG. 4-13 – LUBRICATION LINES (OPTIONAL)..... | 4-11 |
| FIG. 4-14 – ODP (OPEN DRIP PROOF) | 4-13 |
| FIG. 4-15 – TEFC (TOTALLY ENCLOSED FAN COOLED)..... | 4-13 |
| FIG. 4-16 – GREASE FITTINGS | 4-14 |
| FIG. 4-17 – TYPICAL FILTERS..... | 4-15 |
| FIG. 4-18 – ANGLE FILTER INSTALLATION. | 4-15 |
| FIG. 4-19 – SIDE LOAD FILTER INSTALLATION. | 4-15 |
| FIG. 4-20 – FILTER LATCHES..... | 4-16 |
| FIG. 4-21 – CORRECTLY INSTALLED LATCH P/N 315-004-003..... | 4-18 |
| FIG. 4-22 – FULLY INSTALLED FILTER | 4-18 |
| FIG. 4-23 – CORRECTLY INSTALLED LATCH P/N 315-004-000..... | 4-19 |
| FIG. 4-24 – PLACE THE END OF THE LATCH OVER THE FILTER FRAME, SECURING THE FILTER TO THE FRAME..... | 4-19 |
| FIG. 4-25 – FULLY INSTALLED FILTER | 4-20 |
| FIG. 4-26 – INSTALL LATCH P//N 315-004-000..... | 4-21 |
| FIG. 4-27 – FULLY INSTALLED FILTERS | 4-21 |
| FIG. 4-28 – CORRECT USE OF KNOCKOUTS | 4-22 |
| FIG. 4-29 – CORRECT LATCH/KNOCKOUT CONFIGURATION. | 4-22 |
| FIG. 4-30 – FRAME WITH 4 LATCHES INSTALLED. | 4-22 |
| FIG. 4-31 – SPRING LATCH SHOULD BE PULLED AND FASTENED IN HOLE IN THE HEADER OF THE FILTER. | 4-23 |
| FIG. 4-32 – CORRECT LATCH/KNOCKOUT CONFIGURATION. P/N 315-004-001 | 4-23 |
| FIG. 4-33 – FRAME WITH 4 LATCHES INSTALLED | 4-24 |
| FIG. 4-34 – PREFILTER LATCH AFTER INSTALLATION ONTO FILTER HEADER..... | 4-24 |
| FIG. 4-35 – POSITION PREFILTER IN FRONT OF THE FINAL FILTER. (2" W/315-003-002 LATCH SHOWN) | 4-24 |
| FIG. 4-36 – SPRING THE END OF THE LATCH SO THAT IT FITS OVER THE EDGE OF THE PREFILTER. (4" W/315-003-004 LATCH SHOWN) | 4-25 |
| FIG. 4-37 – COMPLETED ASSEMBLY..... | 4-25 |
| FIG. 4-38 – HEPA FILTER FRAME CROSS SECTION VIEW | 4-26 |
| FIG. 4-39 – VISUAL CONTROL FILTER CLAMPS | 4-26 |
| FIG. 4-40 – HEPA FILTER INSTALLATION | 4-27 |
| FIG. 4-42 – RINSE SEGMENTS WITH CLEAN WATER | 4-31 |
| FIG. 4-43 – DIAMETER SEAL ADJUSTMENT | 4-31 |
| FIG. 4-44 – ENERGY RECOVERY WHEEL, BEARING SUPPORT BEAM SIDE | 4-32 |
| FIG. 4-45 – MAINTENANCE REQUIREMENTS FOR YORK SOLUTION HANDLER | 4-33 |

LIST OF FIGURES (CONT.)

| | |
|---|------|
| FIG. 5-1 – CONSTRUCTION OF PITOT TUBE..... | 5-2 |
| FIG. 5-2 – PITOT TUBE..... | 5-3 |
| FIG. 5-3 – INCLINED MANOMETER | 5-3 |
| FIG. 5-4 – MINIHILIC FILTER GAUGE | 5-3 |
| FIG. 5-5 – “U” TUBE MANOMETERS..... | 5-4 |
| FIG. 5-6 – SLACK-TUBE MANOMETER | 5-4 |
| FIG. 5-7 – STATIC PRESSURE - AIR SYSTEM..... | 5-5 |
| FIG. 5-8 – TYPES OF CENTRIFUGAL FAN IMPELLERS..... | 5-7 |
| FIG. 5-9 – FC FAN SHAFT AND WHEEL MARKING | 5-7 |
| FIG. 5-10 – AIRFOIL WITH CONE ASSEMBLY..... | 5-8 |
| FIG. 5-11 – SEALED BEARING | 5-9 |
| FIG. 5-12 – BEARING WITH SETSCREW TYPE LOCKING DEVICE | 5-10 |
| FIG. 5-13 – BEARING WITH ECCENTRIC CAM..... | 5-12 |
| FIG. 5-14 – BEARING INSTALLATION – ECCENTRIC LOCKING COLLAR..... | 5-12 |
| FIG. 5-15 – SPLIT BEARING | 5-14 |
| FIG. 5-16 – SPLIT BEARING ASSEMBLY..... | 5-15 |
| FIG. 5-17 – INSERTION OF CAPSCREWS..... | 5-18 |
| FIG. 5-18 – STANDARD MOUNTING | 5-18 |
| FIG. 5-19 – REVERSE MOUNTING | 5-18 |
| FIG. 5-20 – ADJUSTABLE PITCH SHEAVE (JVS)..... | 5-20 |
| FIG. 5-21 – ADJUSTABLE PITCH SHEAVE (FHP) | 5-21 |
| FIG. 5-22 – ASSEMBLY OF CONNECTORS..... | 5-23 |
| FIG. 5-23 – MOTOR WIRE CONNECTIONS..... | 5-23 |
| FIG. 5-24 – DETERMINING LEFT - OR RIGHT-HAND COIL CONNECTION / DRIVE SIDE | 5-25 |
| FIG. 5-25 – DOOR REPLACEMENT..... | 5-28 |
| FIG. 5-26 – OLD STYLE DOOR WITH MITERED CORNER GASKET | 5-29 |
| FIG. 5-27 – CUTTING END OF GASKET | 5-29 |
| FIG. 5-28 – MARKING GASKET FOR FIRST CUT | 5-30 |
| FIG. 5-29 – MAKING FIRST CUT ON GASKET | 5-30 |
| FIG. 5-30 – MAKING SECOND CUT ON GASKET | 5-30 |
| FIG. 5-31 – CUT BACK STEM | 5-30 |
| FIG. 5-32 – APPLY SEALANT TO OVERLAPPING SPLICE AREA | 5-30 |
| FIG. 5-33 – APPLY SEALANT TO CORNER..... | 5-31 |
| FIG. 5-34 – PLACE ANGLE CUT IN CORNER AND APPLY SEALANT TO NOTCHED AREA..... | 5-31 |
| FIG. 5-35 – MARK LOCATION FOR CUTTING NEXT CORNER..... | 5-31 |
| FIG. 5-36 – MARK GASKET FOR OVERLAP LOCATION..... | 5-32 |
| FIG. 5-37 – APPLY SEALANT TO EDGE AND AROUND “IN PLACE” GASKET..... | 5-32 |
| FIG. 5-38 – OVERLAP CUT PIECE WITH “IN PLACE” GASKET | 5-32 |
| FIG. 5-39 – APPLY SEALANT TO SPLICE BASE | 5-32 |
| FIG. 5-40 – ENSURE ALL CORNERS HAVE ADEQUATE SEALANT..... | 5-33 |
| FIG. 5-41 – CORRECT MITERED FOAM GASKET CORNER..... | 5-33 |
| FIG. 5-42 – INCORRECT MITERED FOAM GASKET CORNER | 5-33 |

LIST OF FIGURES (CONT.)

| | |
|---|-------------|
| FIG. 5-43 – NEW STYLE DOOR WITH BUT CORNER JOINT GASKET (UNITS PRODUCED JAN 2006 THROUGH OCT 2008) | 5-34 |
| FIG. 5-44 – CUT IN 1/8" UNDER HARD PORTION OF GASKET. | 5-34 |
| FIG. 5-45 – SNIP OFF HARD PORTION OF GASKET. | 5-34 |
| FIG. 5-46 – FINISHED CUT | 5-34 |
| FIG. 5-47 – APPLY FIRST PIECE OF HORIZONTAL GASKET | 5-35 |
| FIG. 5-48 – APPLY SEALANT IN CORNERS. | 5-35 |
| FIG. 5-49 – ATTACH GASKET TO ONE CORNER | 5-35 |
| FIG. 5-50 – ROLL GASKET TO OTHER CORNER | 5-35 |
| FIG. 5-51 – APPLY SEALANT FOR FIRST VERTICAL GASKET | 5-36 |
| FIG. 5-52 – APPLY SEALANT END OF FIRST VERTICAL GASKET | 5-36 |
| FIG. 5-53 – POSITION FIRST VERTICAL GASKET | 5-36 |
| FIG. 5-54 – GOOD VERTICAL TO HORIZONTAL BUT JOINT | 5-36 |
| FIG. 5-55 – ROLL GASKET TO WITHIN 5 TO 6" OF OPPOSITE END | 5-37 |
| FIG. 5-56 – TRIM GASKET END | 5-37 |
| FIG. 5-57 – MARK VERTICAL GASKET | 5-37 |
| FIG. 5-58 – POSITION VERTICAL GASKET | 5-38 |
| FIG. 5-59 – PROPER PLACEMENT OF VERTICAL TO HORIZONTAL GASKET | 5-38 |
| FIG. 5-60 – ROLL VERTICAL GASKET INTO PLACE AND SECURE | 5-38 |
| FIG. 5-61 – ROLL TOWARDS OPPOSITE END OF VERTICAL GASKET | 5-38 |
| FIG. 5-62 – WIPE OFF EXCESS SEALANT | 5-38 |
| FIG. 5-63 – APPLY CLAMP TO CORNER AS NECESSARY | 5-39 |
| FIG. 5-64 – UNACCEPTABLE BUT JOINT, STEP-OFF BETWEEN GASKET SURFACES | 5-39 |
| FIG. 5-65 – UNACCEPTABLE BUT JOINT, VERTICAL GASKET NOT PUSHED IN FAR ENOUGH ... | 5-39 |
| FIG. 5-66 – STEEL FRAME DOOR WITH BUT CORNER JOINT GASKET (UNITS PRODUCED AFTER OCT 2008) | 5-40 |
| FIG. 5-67 – CUT GASKET AND PEEL BACKER | 5-40 |
| FIG. 5-68 – PLACE GASKET ON LATCH SIDE OF FRAME | 5-41 |
| FIG. 5-69 – APPLY GASKET TO CORNER | 5-41 |
| FIG. 5-70 – START CORNER | 5-41 |
| FIG. 5-71 – EXAMPLE OF A GOOD GASKET CORNER | 5-41 |
| FIG. 5-72 – UNACCEPTABLE CORNER - TOO TIGHT | 5-42 |
| FIG. 5-73 – UNACCEPTABLE CORNER - GASKET EDGE NOT TOUCHING CORNER OF ANTICOMPRESSION LEG. | 5-42 |
| FIG. 5-74 – LAY GASKET ON GASKET LEG | 5-42 |
| FIG. 5-75 – UNACCEPTABLE GASKET FIT - GAP TOO BIG | 5-42 |
| FIG. 5-76 – UNACCEPTABLE GASKET FIT - GASKET OVERHANGS ANTICOMPRESSION LEG. ... | 5-43 |
| FIG. 5-77 – CUT GASKET AT STARTING POINT | 5-43 |
| FIG. 5-78 – POSITION GASKET FOR SECURING | 5-43 |
| FIG. 5-79 – PUSH GASKET INTO SECURED POSITION | 5-43 |
| FIG. 5-80 – FINAL POSITIONING | 5-44 |
| FIG. 5-81 – EXAMPLE OF A GOOD FINISHED JOINT | 5-44 |
| FIG. 5-82 – EXAMPLE OF AN UNACCEPTABLE JOINT - OPEN JOINT | 5-44 |

LIST OF FIGURES (CONT.)

| | |
|--|------|
| FIG. 5-83 – EXAMPLE OF AN UNACCEPTABLE JOINT - LESS OBVIOUS OPEN JOINT | 5-44 |
| FIG. 5-84 – EXAMPLE OF AN UNACCEPTABLE JOINT - OFFSET JOINT | 5-44 |
| FIG. 5-85 – EXAMPLE OF AN UNACCEPTABLE JOINT - POOR JOINT | 5-45 |
| FIG. 5-86 – GASKET SPLICE REQUIREMENTS..... | 5-45 |
| FIG. 5-87 – STANDARD DOOR LATCHES, IN SWING, OUT SWING & MULTI PT. LATCH | 5-47 |
| FIG. 5-88 – ISOLATOR MOUNTING | 5-49 |
| FIG. 5-89 – SUPPLY FAN RESTRAINT | 5-50 |
| FIG. 5-90 – THRUST RESTRAINT ASSEMBLY | 5-51 |
| FIG. 5-91 – C-CHANNEL..... | 5-52 |
| FIG. 5-92 – REMOVE COMPONENTS PRIOR TO REMOVING PANELS. | 5-54 |
| FIG. 5-93 – INSTALL PANELS..... | 5-54 |
| FIG. 5-94 – APPLY CENTERED OVER SEAM | 5-55 |
| FIG. 5-95 – UNDER DRIP AND OVERHANG | 5-55 |
| FIG. 5-96 – DO NOT STRETCH..... | 5-55 |
| FIG. 5-97 – APPLY PRESSURE - ROLLER RECCOMENDED..... | 5-56 |
| FIG. 5-98 – PENETRATIONS AND GROMMET DETAILS | 5-57 |
| FIG. 5-99 – C-CHANNEL..... | 5-58 |
| FIG. 5-100 – INSTALL PANELS..... | 5-59 |
| FIG. 5-101 – DOOR REPLACEMENT..... | 5-59 |
| FIG. 5-102 – LIGHT ASSEMBLY PULL SWITCH SHOWN)..... | 5-60 |
| FIG. 5-103 – REMOVE ELECTRICAL CONNECTORS | 5-60 |
| FIG. 5-104 – MINIHASIC GAGE..... | 5-61 |
| FIG. 5-105 – ASSEMBLY OF GAGE TO LINER COVER PLATE..... | 5-61 |
| FIG. 5-106 – FILTER GAGE DIAGRAMS | 5-63 |
| FIG. 5-107 – ENERGY RECOVERY WHEEL, PULLEY SIDE | 5-64 |
| FIG. 5-108 – SEGMENT RETAINER | 5-64 |
| FIG. 5-109 – SEGMENT INSTALLATION | 5-65 |
| FIG. 5-110 – PULLEY LOCATION | 5-65 |
| FIG. 5-111 – ATTACHING THE HOOK END OF BELT TO WHEEL RIM WITH TAPE | 5-66 |
| FIG. 5-112 – CROSS SECTIONAL VIEW OF HOOK END OF BELT ATTACHED TO WHEEL RIM WITH TAPE | 5-66 |
| FIG. 5-113 – LINK BELT ENDS TOGETHER..... | 5-66 |
| FIG. 5-114 – INSERT RIGHT ANGLE BELT RETAINING CLIP | 5-67 |
| FIG. 5-115 – RETAINING CLIP WITHIN A FEW INCHES OF THE BEARING SUPPORT BEAM..... | 5-67 |
| FIG. 5-116 – STRETCHING BELT OVER PULLEY | 5-68 |
| FIG. 5-117 – SECURING DOOR CHAIN ASSEMBLY | 5-70 |
| FIG. 5-118 – DIRECT COUPLED ACTUATOR ON JACKSHAFT | 5-71 |
| FIG. 5-119 – MIXING DAMPER WALL PUSHED OUT OF PLACE..... | 5-72 |
| FIG. 5-120 – SECURE MIXING DAMPER WALL TO SIDE PANEL | 5-73 |
| FIG. 5-121 – INSTALL BRACING TO MIXING DAMPER WALL ON EITHER SIDE OF DAMPERS..... | 5-73 |
| FIG. 5-122 – CENTER AND INSTALL BRACING BETWEEN DAMPERS..... | 5-74 |
| FIG. 5-123 – INSTALL ANGLE BRACKETS..... | 5-74 |

LIST OF FIGURES (CONT.)

| | |
|--|------|
| FIG. 5-124 – ID FAN ASSEMBLY COMPONENT CALL OUT | 5-75 |
| FIG. 5-125 – OPEN FUSE DISCONNECTS | 5-75 |
| FIG. 5-126 – REMOVE ID FAN WIRES AND ID AIRFLOW SWITCH WIRES..... | 5-75 |
| FIG. 5-127 – REMOVE WIRING AND CONDUIT FROM CONTROL PANEL..... | 5-76 |
| FIG. 5-128 – REMOVE EXHAUST VENT LOCKING COLLAR COVER AND LOCKING COLLAR..... | 5-76 |
| FIG. 5-129 – REMOVE CONDENSATE DRAIN TRAP | 5-76 |
| FIG. 5-130 – REMOVE ID FAN FLANGE FROM HEAT EXCHANGER..... | 5-76 |
| FIG. 5-131 – REMOVE ID FAN HOUSING FROM HEAT EXCHANGER..... | 5-77 |
| FIG. 5-132 – REMOVE OLD GASKET..... | 5-77 |
| FIG. 5-133 – TRIM GASKET | 5-77 |
| FIG. 5-134 - CAULK BETWEEN HEAT EXCHANGER AND SHEET METAL COVER SPANEL | 5-77 |
| FIG. 5-135 – INSTALL NEW GASKET AND CAULK GASKET INNER EDGE | 5-78 |
| FIG. 5-136 – INSTALL ID FAN FLANGE ONTO HEAT EXCHANGER..... | 5-78 |
| FIG. 5-137 – APPLY SEALANT TO LOCKING COLLAR GROOVES..... | 5-78 |
| FIG. 6-1 – FULL VOLTAGE STARTER (204194)..... | 6-2 |
| FIG. 6-2 – FULL VOLTAGE STARTER WITH SINGLE POINT POWER CONNECTION (204195) | 6-4 |
| FIG. 6-3 – OUTSIDE AIR DAMPER KIT - RELAY INSTALLATION..... | 6-6 |
| FIG. 6-4 – TERMINATION CHART INSIDE ENCLOSURE DOOR | 6-7 |
| FIG. 6-5 – YORK SOLUTION FPC WIRING (204197)..... | 6-8 |
| FIG. 6-6 – TRANSFORMER ENCLOSURE WIRING DETAIL SHOWN OPEN | 6-9 |
| FIG. 6-7 – TRANSFORMER WIRING DIAGRAM | 6-10 |
| FIG. 6-8 – UV CONTROL PANEL WIRING - 8A | 6-11 |
| FIG. 6-9 – UV CONTROL PANEL WIRING - >8A | 6-12 |
| FIG. 6-10 – GAS HEAT, SINGLE PHASE, 1500VA TRANSFORMER, WIRING DIAGRAM..... | 6-14 |
| FIG. 6-11 – GAS HEAT, (1) THREE PHASE MOTOR, 1000VA TRANSFORMER, WIRING DIAGRAM | 6-15 |
| FIG. 6-12 – GAS HEAT, (2) THREE PHASE MOTORS, 500VA TRANSFORMER, WIRING DIAGRAM | 6-16 |

LIST OF TABLES

| | |
|---|-------------|
| TABLE 1 – SEGMENT IDENTIFICATION | 31 |
| TABLE 2 – UNIT NOMENCLATURE..... | 32 |
| TABLE 1-1 - SPACING REQUIREMENTS FOR OFFLOADING LONG UNITS | 1-2 |
| TABLE 3-1 – TORQUE FOR TIGHTENING SETSCREWS | 3-3 |
| TABLE 3-2 – NATURAL GAS PRESSURE REQUIREMENTS (INCHES WC) | 3-18 |
| TABLE 3-3 – PIPE SIZE REQUIRED..... | 3-19 |
| TABLE 3-4 – BURNER TEPERATURE RISE | 3-23 |
| TABLE 3-5 – INSPECTION REQUIREMENTS | 3-29 |
| TABLE 4-1 – MINIMUM MAINTENANCE ACTIVITY AND FREQUENCY (ASHRAE STANDARD 62-2001 FOR INDOOR AIR QUALITY). | 4-2 |
| TABLE 4-2 – FAN BEARING – LUBRICATION INTERVALS - BALL BEARING PILLOW BLOCKS | 4-12 |
| TABLE 4-3 – FAN BEARING – LUBRICATION INTERVALS - SPHERICAL ROLLER BEARING SOLID PILLOW BLOCKS..... | 4-12 |
| TABLE 4-4 – FAN BEARING – LUBRICATION INTERVALS - SPHERICAL ROLLER BEARING-SPLIT PILLOW BLOCKS..... | 4-12 |
| TABLE 4-5 – MOTOR BEARING – LUBRICATION INTERVALS..... | 4-14 |
| TABLE 4-6 – MOTOR BEARING – SERVICE CONDITIONS..... | 4-14 |
| TABLE 4-7 – MOTOR BEARING – LUBRICATION INTERVAL MULTIPLIER..... | 4-14 |
| TABLE 5-1 – TORQUE FOR TIGHTENING SET SCREWS | 5-8 |
| TABLE 5-2 – RECOMMENDED CLEARANCE REDUCTION VALUES OF SKF TAPERED BORE BEARINGS (IN INCHES)..... | 5-17 |
| TABLE 5-3 – RECOMMENDED CAP BOLT TORQUE VALUES FOR SPLIT PILLOW BLOCK..... | 5-17 |
| TABLE 5-4 – CAPSCREW TORQUE VALUES FOR FIXED PITCH SHEAVES..... | 5-19 |
| TABLE 5-5 – CONNECTORS & SLEEVES WITH STRIP LENGTHS | 5-24 |
| TABLE 5-6 – TORQUE CHART - TIGHTENING TORQUE IN INCH POUNDS..... | 5-24 |
| TABLE 5-7 – CROSS REFERENCE; CONTINUOUS TO SINGLE LINK BELT/BELT PULLEY KITS ... | 5-69 |
| TABLE 5-8 – TROUBLESHOOTING TIPS..... | 5-79 |

SERVICE TASK REFERENCE

| | |
|--|------|
| Adjustable Motor Base | |
| Operation | 4-5 |
| Air Hood, Outside and/or Relief Air | |
| Installation | 2-24 |
| Orientation | 2-24 |
| Inspection | 2-24 |
| Air Louvers | |
| Inspection | 4-4 |
| Air Modulator | |
| Start-up | 3-7 |
| Belts | |
| Checking Tension | 4-7 |
| Bird Screen | |
| Installation | 2-24 |
| Inspection | 4-4 |
| Cabinet Maintenance | |
| Cleaning | 4-3 |
| Clearance | |
| Outdoor Unit | 2-1 |
| Indoor Unit | 2-5 |
| Coils | |
| Piping | 2-45 |
| Water | 2-46 |
| Freeze Protection | 2-48 |
| Steam | 2-49 |
| Vertical Interface & Bypass (VIFB) | 2-50 |
| Horizontal Interface & Bypass (IFB) | 2-50 |
| Direct Expansion (DX) | 2-54 |
| Cleaning | 4-28 |
| Replacement | 5-25 |
| Controls | |
| Control Wiring | 3-2 |
| Humidifier | 2-43 |
| Curb | |
| Assembly & Installation | 2-3 |
| Dampers | |
| Installation of Multizone Dampers | 2-26 |
| Checking Operation | 3-5 |
| Blade Orientation | 3-6 |
| Cleaning | 4-28 |
| Hardware Check | 4-28 |
| Mixing Damper Wall Repair | 5-72 |
| Damper Actuator | |
| Installation | |
| Multizone Actuators | 2-26 |
| Direct Coupled Mounting | 3-6 |
| Maintenance | |
| Multizone Actuators | 2-27 |
| Direct Coupled Replacement & Adjustment | 5-71 |

| | |
|---|------|
| Doors | |
| Start-up Inspection | 3-8 |
| Door Replacement | 5-28 |
| Gasket Replacement | 5-29 |
| Handle / Latch Replacement & Adjustment | 5-46 |
| Field Modification to Add Doors | 5-58 |
| Add Door Safety Chain | 5-70 |
| Drain Lines | |
| Combining | 2-62 |
| Cleaning | 4-29 |
| Freeze Protection | 4-30 |
| Drain Pan | |
| Cleaning | 2-61 |
| Field Testing | 4-29 |
| Freeze Protection | 4-30 |
| Drain Trap | |
| Installation | 2-61 |
| Cleaning | 4-29 |
| Freeze Protection | 4-30 |
| Drive Kit | |
| Inspection | 4-4 |
| Duct Connections | |
| Effective Duct Length | 2-62 |
| Turns | 2-62 |
| Front Discharge Outdoor Duct Installation | 2-64 |
| Sound & Vibration | 2-64 |
| Electrical Connections | 2-36 |
| Requirements | 2-36 |
| Penetrations | 5-56 |
| Power Connections | |
| Energy Recovery Wheel | 2-37 |
| Gas Heat | 2-38 |
| Electric Heat | 2-39 |
| Humidifier | 2-43 |
| Electric Heat | |
| Power Connections | 2-39 |
| Control Wiring | 3-2 |
| Energy Recovery Wheel | |
| Power Connections | 2-37 |
| Control Wiring | 3-2 |
| Start-up | 3-9 |
| Replacing Wheel Segments | 5-64 |
| Wheel Drive Motor & Pulley Replacement | 5-65 |
| Belt Replacement | 5-56 |
| External Lube Lines | 4-11 |
| Fan Assembly | |
| Pre Start-up Inspection | 3-3 |
| Cleaning | 4-4 |
| Maintenance Inspection | 4-4 |

SERVICE TASK REFERENCE (CONT.)

| | |
|--|------|
| Fan Bearing | |
| Types | 4-10 |
| Lubrication | 4-11 |
| Replacement | 5-9 |
| Fan Motor | |
| Energizing at Start-up | 3-7 |
| Inspection & Maintenance | 4-12 |
| Bearing Lubrication | 4-13 |
| Replacement | 5-23 |
| Fan | |
| Cleaning | 4-4 |
| Inspection | 4-4 |
| Replacement & Adjustment | 5-6 |
| Repair | 5-7 |
| Gas Heat | |
| Power Connections | 2-38 |
| Control Wiring | 3-2 |
| Inducer Fan Gasket Replacement | 5-75 |
| Wiring Diagrams | 6-1 |
| UNIT INSTALLATION | 2-7 |
| Tools & Materials | 2-7 |
| Ship Loose Parts | 2-8 |
| Indoor Unit | |
| Multiple Piece | 2-7 |
| Tiered or Stacked | 2-21 |
| Outdoor Unit | |
| Single Piece | 2-13 |
| Multiple Piece | 2-13 |
| Shipping Splits | |
| Examples | 2-12 |
| End Channel | 2-23 |
| Filters (AF, FF, RF) | |
| Types | 4-15 |
| Maintenance And Replacement | 4-15 |
| Inserting into Side Load Filter Tracks | 4-15 |
| Filters (HEPA) | |
| Installation | 4-27 |
| Isolators | |
| Preparing for operation | 3-4 |
| Isolator Spring Replacement and Adjustment | 5-49 |
| Humidifiers | |
| Power Connections | 2-43 |
| Control Wiring | 2-43 |
| Latches (Door) | |
| Start-up Inspection | 3-8 |
| Replacement & Adjustment | 5-46 |
| Long Term Storage | 1-5 |
| Fan Check | 1-5 |
| Preventive Maintenance | 1-5 |
| Mist Eliminator | |
| Installation | 2-24 |
| Inspection | 2-24 |

| | |
|---|------|
| Motors | |
| Check Amperage after Air Balancing | 4-3 |
| Repair | 5-24 |
| Replacement | 5-23 |
| Mounting | |
| Ceiling Suspended Unit | 2-26 |
| Outdoor Unit | 2-5 |
| Indoor Unit | 2-5 |
| Pipe Chase | |
| Installation | 2-30 |
| Caulking Pipe Chase to Air Handler | 2-32 |
| Caulking & Installation of Cover Angle | 2-32 |
| Caulking & Installation of Baserail Covers | 2-33 |
| Panels | |
| Field Cut Openings (Ducts, Dampers etc.) | 5-52 |
| Replacement | 5-53 |
| Field Modification for Doors | 5-58 |
| Pressure Tape Removal and Installation on XTO Roof Panels | 5-54 |
| Piping | |
| Connections | 2-45 |
| Condensate Drain | 2-61 |
| Drain Trap | 2-61 |
| Penetrations | 5-57 |
| Receiving Inspection | 1-4 |
| Rigging | |
| Indoor & Outdoor Units | 1-1 |
| Spacing Requirements for Offloading Long Units | 1-2 |
| Sheaves | |
| Replacing after Air Balancing | 3-8 |
| Alignment | 4-7 |
| Replacement & Adjustment | 5-18 |
| Short Term Storage | 1-4 |
| Start-up | 3-1 |
| Start-up Checklist | 3-27 |
| Steel Frame Assembly | 2-3 |
| Test & Balance | |
| Air Balance | 3-31 |
| Dynamic Balance | 3-31 |
| Thrust Restraint | |
| Replacement & Adjustment | 5-51 |
| Tiered Unit | |
| Installation | 2-21 |
| Variable Frequency Drive (VFD) | |
| Set Up of Non Factory Mounted VFD | 3-7 |

THIS PAGE INTENTIONALLY LEFT BLANK

INTRODUCTION

GENERAL

This manual has been prepared as a guide for installing, operating and maintaining YORK Solution Air Handling Units. Johnson Controls has produced a quality product that is adaptable to almost any comfort or industrial application. However, proper installation, operation and maintenance must be followed to realize the full capacity and life of the units.

This instruction contains general recommendations, but specific requirements may apply to the individual installation. Such requirements are outlined in federal, state and local safety codes. Strict compliance with these codes and strict adherence to these instructions are the responsibility of the user. Particular attention should be given to electrical wiring and other safety elements such as design working pressures and requirements of the Government Clean Air Act Amendments as it applies to refrigerant types and charges. General safety practices are covered in AMCA Publication 410-90.

Read the entire instruction before installing or operating the air handler. Specific details and requirements apply that require careful consideration to avoid damage to the equipment and injury to the installer or operator.

The YORK Solution features segmented construction and is factory assembled. Segment arrangements will vary to suit job application (*see Fig. 1*). Heavy gauge galvanized steel is used on the exterior and interior of the unit. Access doors are provided for accessibility to the various sections. Removable access panels are standard in lieu of doors on Commercial Performance units. Panels and doors are double wall construction. Panels, doors and structural frame are insulated with spray-injected foam.

TYPICAL YORK SOLUTION OPERATION IN "HVAC" SYSTEM

The operation of these units can be divided into systems:

1. Ventilation system.
2. Economizer system (return air/mixing box section).
3. Heating system.
4. Cooling system.

VENTILATION SYSTEM

A ventilation system simply replaces the air in a given space. Usually the purpose is to remove air that is substandard to creature comfort or a process and replace it with suitable air. Depending on the application the system will operate at various specified rates, volumes and conditions. A ventilation system may employ an air handler with a supply fan working in conjunction with other remote exhaust fan(s). A more effective method would employ both a supply fan and an exhaust fan in the air handler.

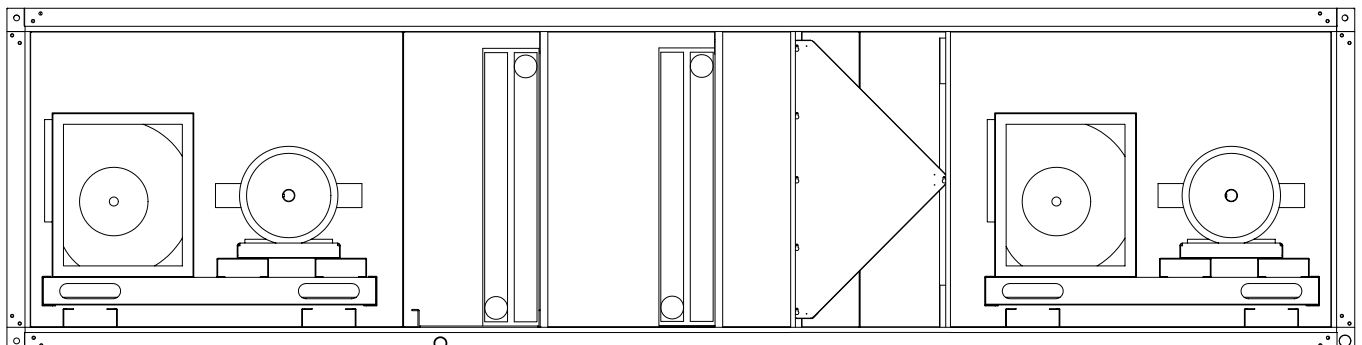


FIG. 1 – CUTAWAY OF YORK SOLUTION SHOWING VARIOUS SEGMENTS

ECONOMIZER SYSTEM - TYPICAL

The Economizer system could typically consist of:

- Outdoor and return air dampers.
- Damper actuator.
- Enthalpy control.
- Minimum outdoor air adjustment.
- Exhaust air control.

The Economizer system provides the first stage of cooling whenever the outdoor air is cool and dry enough to satisfy the internal cooling demand. The outdoor and the return air dampers are operated by individual actuators. As the outdoor air dampers are opened by the damper actuator, the return air dampers are closed.

If the economizer operation cannot satisfy the space demand for cooling, stages can be energized as needed.

HEATING OPERATION

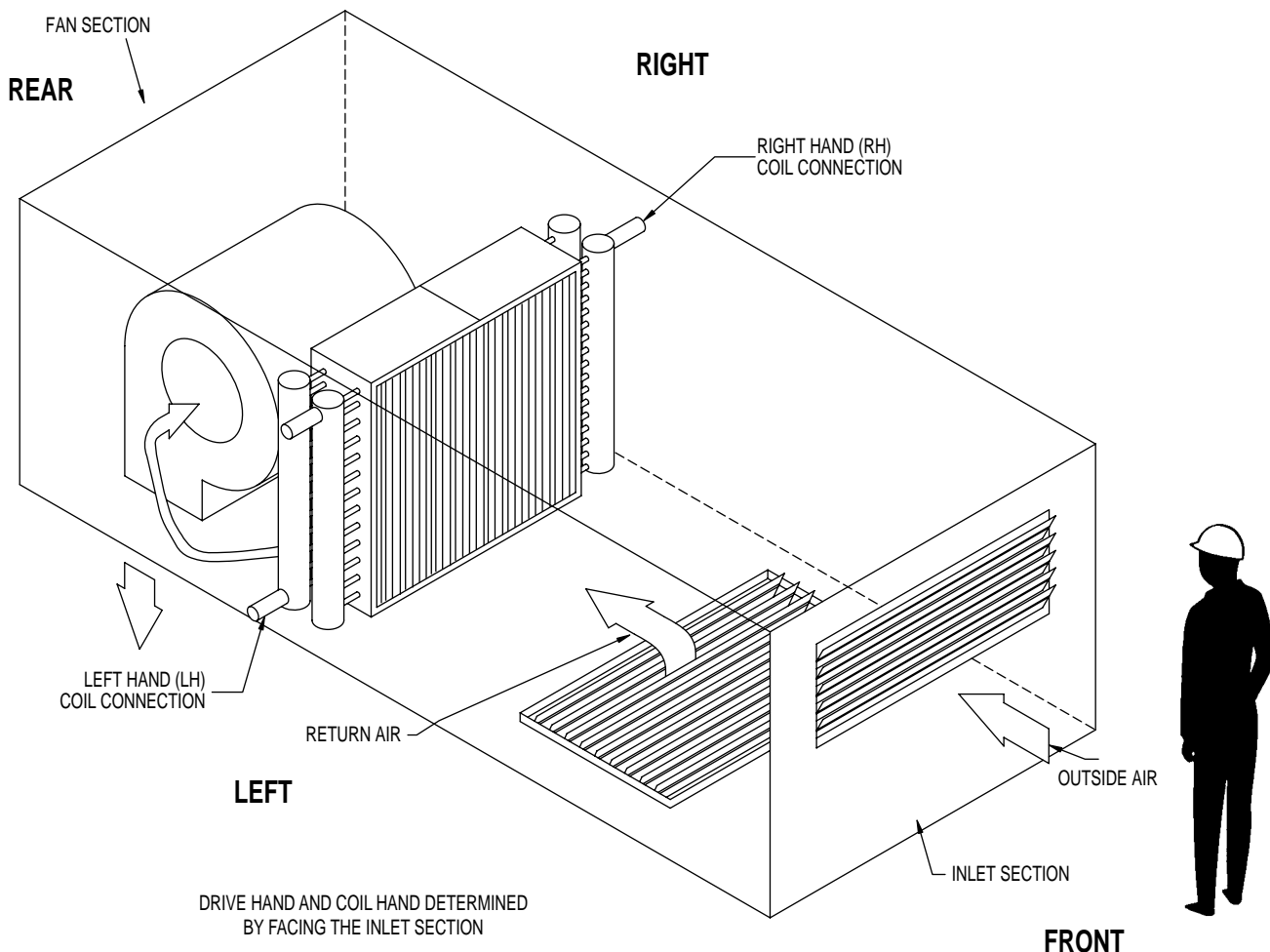
Various types of heating may be applied. Hot water or steam coils maybe specified typically. Electric heat and fuel burner heat are available.

COOLING OPERATION

Various types of cooling may be utilized. Factory mounted chilled water coils or direct expansion refrigerant coils may be specified for the YORK Solution unit.

HAND IDENTIFICATION

Coil connections and other components are located and described as left or right hand. The proper orientation to describe the proper hand is when airflow is at your back, as shown in Fig. 2.



LD08004

FIG. 2 – UNIT AND COIL HAND IDENTIFICATION

SEGMENT IDENTIFICATION

Refer to Tables 1 and 2 for segment identification and nomenclature.

TABLE 1 – SEGMENT IDENTIFICATION

FAN SEGMENTS

- FS – SUPPLY
 - FORWARD CURVED
 - AIRFOIL
 - INDUSTRIAL AIRFOIL
 - SWSI PLENUM
(BELT AND DIRECT DRIVE)
- FR – RETURN
 - FORWARD CURVED
 - AIRFOIL
 - INDUSTRIAL AIRFOIL
 - SWSI PLENUM
(BELT AND DIRECT DRIVE)
- FE – EXHAUST
 - FORWARD CURVED
 - AIRFOIL
 - INDUSTRIAL AIRFOIL
 - SWSI PLENUM
(BELT AND DIRECT DRIVE)

COIL SEGMENTS

- CC – COOLING COIL
- HC – HEATING COIL
- VC – VERTICAL COIL
- MZ - MULTIZONE

HEAT SEGMENTS

- IC – INTEGRAL FACE & BYPASS COIL
- IG – INDIRECT GAS FIRED FURNACE
- EH – ELECTRIC HEATER

ENERGY RECOVERY

- ER – ENERGY RECOVERY

FILTER SEGMENTS

- FF – FLAT FILTER (2" OR 4")
- AF – ANGLE FILTER (2" & 4")
- RF – HIGH EFFICIENCY FILTER
 - RIGID FILTER (12")
 - BAG FILTER (21")
 - MINI-PLEAT FILTER (4")
- HF – HEPA FILTER

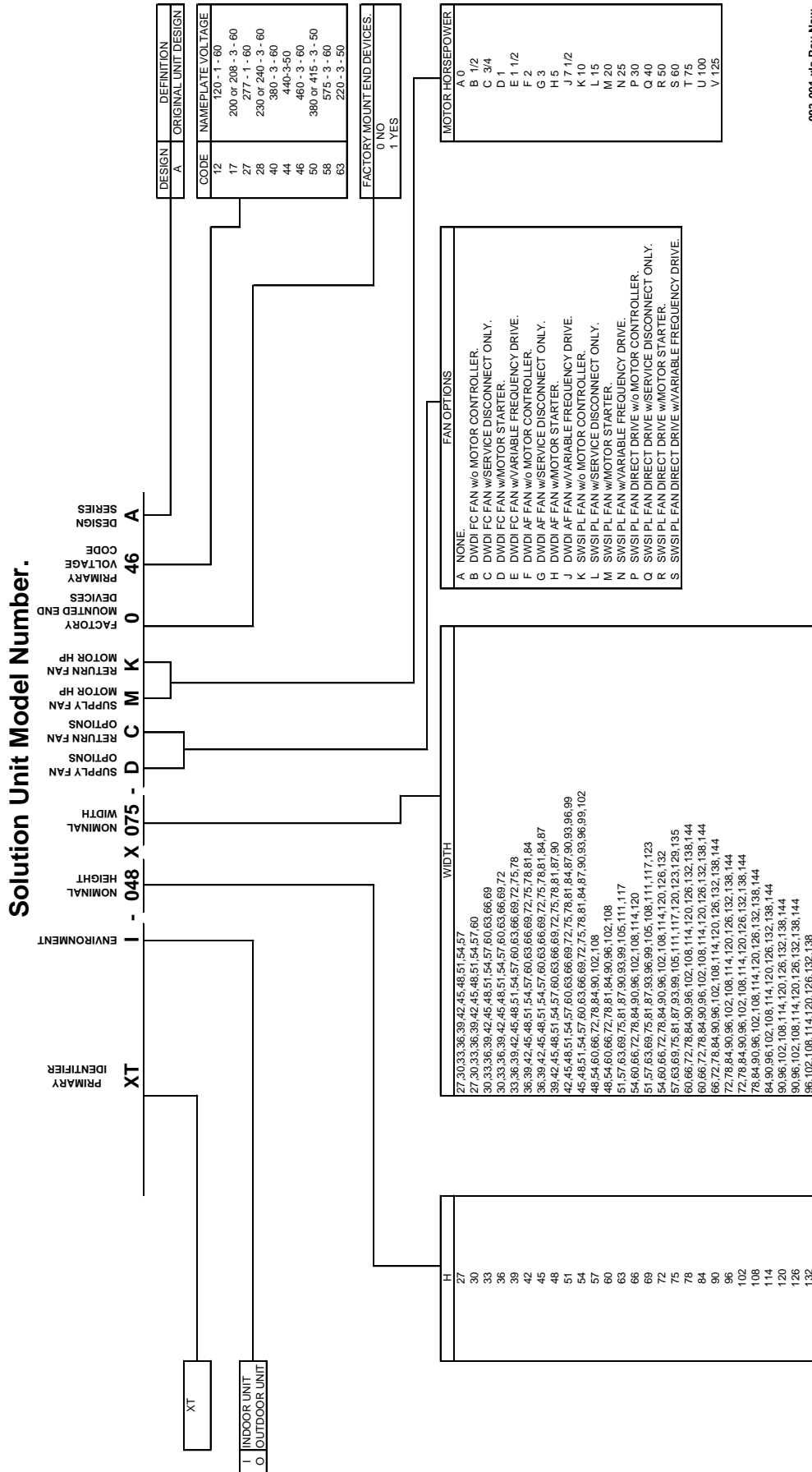
INLET SEGMENTS

- MB – MIXING BOX
- FM – FILTER/MIXING BOX
- EF – FILTER/ECONOMIZER
- EE – ECONOMIZER
- IP – INLET PLENUM
- VE – VERTICAL ECONOMIZER
- VF – VERTICAL FILTER/ECONOMIZER

ACCESSORY SEGMENTS

- VP – VERTICAL PLENUM
- DP – DISCHARGE PLENUM
- TN – TURNING PLENUM
- DI – DIFFUSER
- XA – ACCESS SEGMENT
- AB- AIR BLENDER
- EB – EXTERNAL BYPASS
- IB – INTERNAL BYPASS
- FD – FACE DAMPER
- AT – ATTENUATOR
- HM - HUMIDIFIER
- UV - UVC LAMPS

TABLE 2 – UNIT NOMENCLATURE



003-001.xls Rev New

LD13350

Notes: 1. The height and width numbers only correspond to each other in the same row.
 2. The height and width numbers will always be (3) characters long in the model number.

UNIT IDENTIFICATION

Both indoor and outdoor units are labeled with a Unit ID Label, Skid ID Labels and Loose Component ID Labels. Indoor units are shrink wrapped with Skid ID Labels on the outside of the wrapping as well as on each skid.

| | | |
|--|------------|----------------------|
| YORK Solution | | |
| UNIT ID. THIS PRODUCT MANUFACTURED FOR OUTDOOR USE | | |
| MODEL # | | COM : 117817 |
| XTO-108X120-JJRN046A | | |
| SERIAL # / DATE CODE | | JOB IDENTIFICATION # |
| CHTM XT0085 | | 08-179121-01-01 |
| SEGMENT IDENTIFICATION | | |
| (FS)(CC-HM)(XA-IC-XA-RF)(EE)(FR) | | |
| # OF SKIDS | UNIT TAG # | |
| 5 | AHU 9-10 | |
| ELECTRICAL RATINGS | | |
| TOTAL RATINGS (COMBINED LOADS) | | |
| VOLTS / PH / HZ | M.C.A. | MAX. O.C. PROT. |
| 460/3/60 | | |
| SUPPLY FAN MOTOR RATING (INDIVIDUAL LOAD) | | |
| HP | FLA | M.C.A. |
| 50 | 72 | 90 |
| RETURN FAN MOTOR RATING (INDIVIDUAL LOAD) | | |
| HP | FLA | M.C.A. |
| 25 | 38 | 47.5 |
| HEAT RECOVERY WHEEL MOTOR RATING (INDIVIDUAL LOAD) | | |
| HP | FLA | M.C.A. |
| N/A | N/A | N/A |
| ELECTRIC HEAT RATINGS | | |
| GAS HEAT RATINGS | | |
| N/A | | |
| LIGHTS & OUTLETS | | |
| VOLTS / PH / HZ | M.C.A. | MAX. O.C. PROT. |
| 120/1/60 | 20 | 20 |
| COIL DATA | | |
| HOT WATER COIL MAX. INLET WATER TEMP. | 200 F | |
| STEAM COIL MAX. OPERATING PRESSURE. | 50 | |
| EVAPORATOR COIL DESIGN PRESSURE. | 325 PSI | |
| EVAPORATOR COIL REFRIGERANT USED. | | |
| EVAPORATOR COIL REFRIGERANT OIL USED. | | |
| SUITABLE FOR USE WITH REMOTE CONDENSER; AIR-COOLED, WATER-COOLED, OR VAPORATIVE. THE DESIGN PRESSURE MARKED ABOVE SHALL NOT BE LESS THAN THE DESIGN PRESSURE MARKED ON THE REMOTE CONDENSING UNIT. | | |
| MANUFACTURING LOCATION | | |
| YORK INTERNATIONAL - | East York | FACILITY |
| 1499 E PHILADELPHIA ST | | |
| YORK | PA | 17403 |
| USE COPPER WIRES ONLY. CLEARANCE FROM COMBUSTIBLE SURFACE: UNIT IS 0 INCHES, DUCT IS 0 INCHES. MAXIMUM INLET TEMPERATURE: 100° F / MAXIMUM OUTLET TEMPERATURE: 200° F. EXTERNAL STATIC PRESSURE RANGE OF 0.25" - 5.00" WG. CONFORMS TO UL STD 1995 AND CERTIFIED TO CSA STD C22.2 NO 236 | | |
| | | |
| 9800071 | | |

LD11728A

FIG. 3 – UNIT ID LABEL

UNIT ID LABEL

The Unit ID Label contains the Model #, Serial/Date Code, Job Identification #, Segment Identification, # of Skids, Unit Tag #, Electrical Ratings, Coil Data & Manufacturing Location (see Fig. 3).

SKID ID LABEL

Each skid in a multi piece unit is marked with a Skid ID Label, which indicates its order of assembly in the direction of airflow (see Fig. 4).

| | |
|---|----------------------|
| YORK Solution | |
| MODEL # | COM : 117817 |
| XTO-108X120-JJRN046A | |
| SERIAL # / DATE CODE | JOB IDENTIFICATION # |
| CHTM XT0085 | 08-179121-01-01 |
| SEGMENT IDENTIFICATION | |
| (FS)(CC-HM)(XA-IC-XA-RF)(EE)(FR) | |
| SKID 1 of 5 | UNIT TAG |
| | AHU 9-10 |
| JOB NAME | SKID OVERALL SIZE |
| Owens Corning BLDG-21 | 116 H x 120 W x 59 L |
| AHU 9-10 | |
| Estimated Weight: 4,100 pounds | |

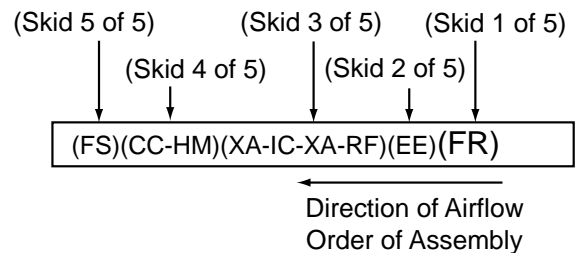
See Fig. 5 for Segment ID explanation

(FR) Bolded indicates skid 1 of 5 is a Return Fan and is placed first in the direction of airflow. See Segment ID box example. LD11729A

FIG. 4 – SKID ID LABEL

SEGMENT IDENTIFICATION BOX

The Segment Identification box indicates the skids and segments* used on a multi piece unit. The contents of each skid are indicated by segment(s) surrounded by parenthesis (see Fig. 5 below).



* See Table 1 for Segment Identification

LD11752A

FIG. 5 – SEGMENT ID BOX EXAMPLE

LOOSE COMPONENT ID LABEL

Each loose component has a label showing where it is to be installed on the unit. The segment identification box on the label will show the skid that it is installed on. If the loose component goes on only one segment on that skid the segment in the box will be bolded (see Fig. 6).

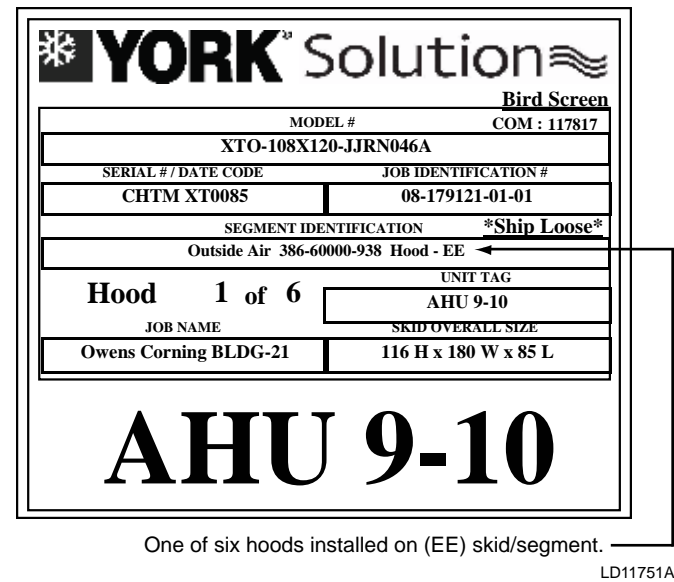
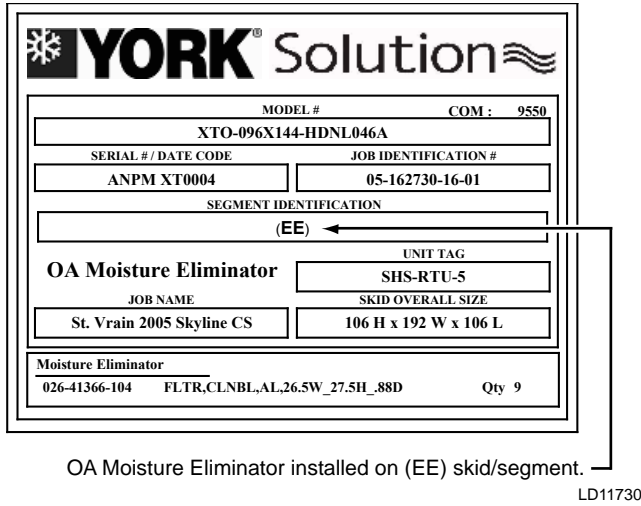


FIG. 6 – LOOSE COMPONENT ID LABELS

FILTER ID LABEL

Fig 7 shows a typical Filter Label with Filter Segment and Filter List.

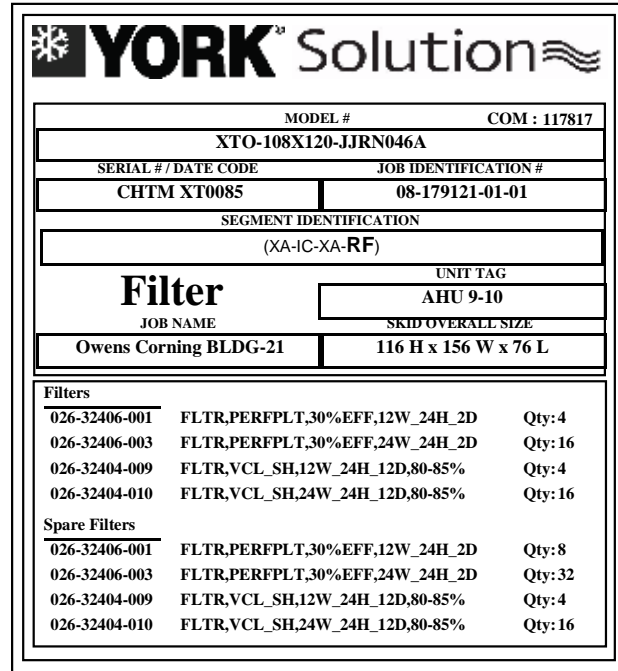


FIG. 7 – FILTER LABELS

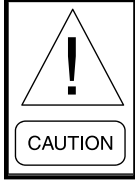
DIRECTION OF AIRFLOW

The direction of airflow is always read from right to left.

1.0 PRE-INSTALLATION

RECEIVING

All units leaving the plant have been inspected to ensure the shipment of quality products. All reasonable means are utilized to properly package the air handling units.

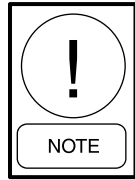


Johnson Controls will NOT be responsible for any damage or loss of parts in shipments or at the job site. Receiver is solely responsible for noting Bill of Lading and filing freight claims IMMEDIATELY. Refer to Shipping Damage Claims Form 50.15-NM available from Johnson Controls Sales representative.

RIGGING OF INDOOR AND OUTDOOR UNITS

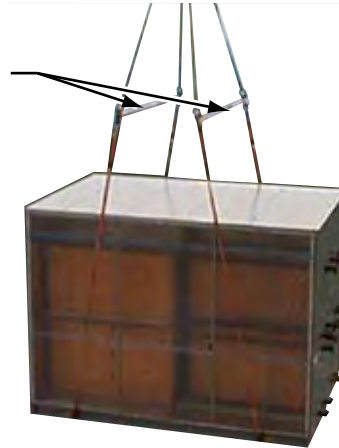


All lifting points must be used to avoid personal injury or death and to avoid damage to the equipment.



SHIPPED LOOSE DAMPERS. When large units are ordered with MZ segments in rear discharge location (on the end of the unit), the units will ship with the top section (hot deck) separated. In these cases, the complete multizone damper assembly (hot deck and cold deck together) will ship loose.

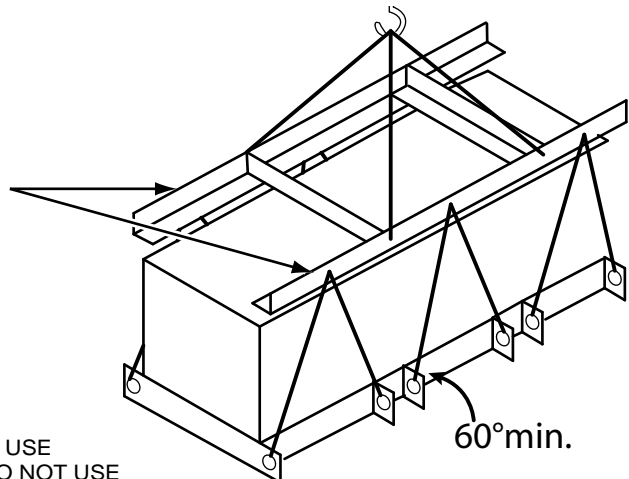
SPREADER BARS MUST BE WIDER THAN THE UNIT WIDTH TO PREVENT DAMAGE TO THE HOUSING & ROOF EDGE.



LD13769

FIG. 1-1 – RECOMMENDED LIFTING WITH FOUR LIFTING POINTS

SPREADER BARS MUST BE WIDER THAN THE UNIT WIDTH TO PREVENT DAMAGE TO THE HOUSING & ROOF EDGE.



RIGGING INSTRUCTIONS

FOR LIFTING AIR HANDLERS WITH LIFTING LUGS, USE SPREADER BARS AND CABLES AS INDICATED. DO NOT USE A FORKLIFT. ALL LIFTING LUGS MUST BE USED TO AVOID DAMAGE.

LD13765B

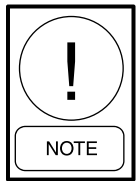
FIG. 1-2 – RECOMMENDED LIFTING WITH MULTIPLE POINTS

OFF-LOADING

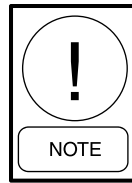
Proper rigging and handling of the equipment is mandatory during unloading and setting it into position to retain warranty status.

Care must be taken to keep the unit in the upright position during rigging and to prevent damage to the air and watertight seams in the unit casing. Prevent unnecessary jarring or rough handling.

For lifting air handling units with lifting lugs or corner connectors; proper spreader bars and hoisting line must be used when rigging to prevent damage to the unit casing (see Fig. 1-1). When lifting long units a special system must be used to insure a minimum 60° angle between lifting lug and spreader bar/frame (see Fig. 1-2 & Table 1-1). It is also mandatory that an experienced and reliable rigger be selected to handle unloading and final placement of the equipment. The rigger must be advised that the unit contains internal components and that it be handled in an upright position. Care must be exercised to avoid twisting the equipment structure.



Refer to the submittal for the section weights.



All lifting lugs must be used to avoid damage to unit. If unit does not have lifting lugs, use bottom corner connectors and intermediate raceway lifting lugs. Do not use top corner connectors.

Unit section weights are furnished on the job submittal. Due to the variance in weight of each unit design, it is not possible to list unit weights in this instruction. The submittal must be referred to when selecting a crane for rigging and figuring roof weight loads. Contact your Johnson Controls Sales representative if you have any questions regarding unit weights.

CRANE AND SPREADER BARS

See Fig's 1-1 and 1-2.

FORK LIFT

Forklifts should not be used to off-load air handlers except in special circumstances. If moving air handling equipment with a fork lift or similar means becomes necessary, always make sure the lifting forks are long enough to reach from the fork truck to the opposite side and slightly beyond. It is helpful to leave the shipping blocks attached to the bottom of the equipment until in its final location. There is no structural support under the equipment except what is visible from the perimeter.

COME-A-LONGS OR POWER PULL

See Fig1-3.

| TABLE 1-1 - SPACING REQUIREMENTS FOR OFFLOADING LONG UNITS | | |
|--|--------------------------|---------------------------|
| UNIT HT. | MAX. LIFTING LUG SPACING | MIN. LIFTING STRAP LENGTH |
| ≤ 72" | 120" | 120" |
| > 72" | 192" | 192" |

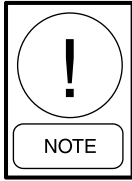


FIG. 1-3 – TYPICAL COME-A-LONG TYPES

LD09613

SHACKLES

Refer to Fig. 1-4 for proper lifting with hook and shackle at corners. Refer to Fig. 1-5 for proper lifting with hook and shackle at lifting lugs.



Fig's 1-4 and 1-5 show YORK Solution unit without baserails. When baserails are present, always use all lifting lugs pre-mounted on baserails. Do not lift by corners.



LD13767

FIG. 1-4 – PROPER LIFTING WITH SHACKLE AT CORNER



LD13768

FIG. 1-5 – PROPER LIFTING WITH SHACKLE AT LIFTING LUG



LD13766

FIG. 1-6 – RECOMMENDED LIFTING WITH BASERAIL

INSPECTION

CHECK FOR DAMAGE

RECEIVER RESPONSIBILITY

Receiver is solely responsible for noting freight bill and filling freight claims IMMEDIATELY (*see "Receiving" in this section*).

Visible damage should be noted on the signed and dated bill of lading with a request that the carrier inspect the damage within 72 HRS. of notification. The shipping wrapper must be removed and replaced with a tarp or similar protective covering. Any concealed damaged reported after 15 days will compromise a claim settlement. Inspection requests may be done by telephone or in person, but should be confirmed in writing. If assistance is needed with the claim process, contact your Johnson Controls Sales representative.

INDOOR UNITS

It is Johnson Controls intention that a shipping wrapper be applied to unpainted indoor units for protection from weather, road dirt, etc. during inland transit and that the wrapper be removed at the time of delivery to allow for a thorough inspection, both inside and out.

OUTDOOR UNITS

Outdoor units are not fully wrapped. Exposed openings are covered for protection from weather, road dirt, etc. during inland transit. A thorough inspection, both inside and out, should be done at the time of delivery.

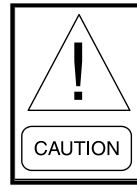
CHECKING FOR NON MOUNTED PARTS

- Check the packing list for non-mounted ship loose parts. (Check inside all segments.)
- Packing list will note how many and type of parts.
- Shortages must be reported within 10 days after receipt of order.

See Ship Loose Parts, Fig 2-8 thru 2-14

STORAGE

SHORT-TERM STORAGE



Indoor Units:

Under no circumstances should outdoor storage be used

Outdoor Units:

Be sure all shipping covers are re-applied after inspection, or tarps are used during storage.

Short-term storage is considered six (6) months or less from date of shipment. Storage maintenance during this time is usually limited to the following.

- Rotate fans every four (4) weeks beginning upon arrival to prevent moisture from damaging bearing.
- If the units are to be stored out-of-doors, prior to installation, special care must be taken to cover and protect the units from dust, rain, snow and rodents. The units must be protected from constant exposure to rain and snow.
- Store on a firm, flat surface to prevent distortion. Block the unit off the ground to protect components from water.



Protect all parts and porous materials from rain and other sources of moisture. Decontaminate or replace as needed to ensure microbial growth is not introduced to the air handler.

- The unit must also be protected from damage to the exterior of the cabinet or coil connections by construction vehicles and personnel.

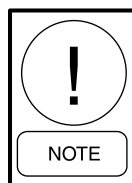
LONG-TERM STORAGE

Long-term storage is considered any period beyond six (6) months from date of shipment. If long-term storage is anticipated, **contact the Johnson Controls Sales representative for the proper instructions and requirements for long-term storage.** It is mandatory that a detailed record be maintained during this long-term period, such as, but not limited to: proper sealing of the cabinet, rotation of the blowers and bearings, and protection of all motors from moisture. *Refer to Form 50.20-NM3 "Long Term Storage Requirement - Field Preparation" and Form 50.20-CL3 "Long Term Storage Periodic Checklist and Logs", copies of which is included in this section.*

PREVENTIVE MAINTENANCE PRIOR TO LONG TERM STORAGE

The following precautions should be taken prior to extended storage:

- Fan and motor bearings are to be greased per the manufacturer's specifications.
- Motors and sheaves must be protected from free moisture or high humidity. This may be accomplished by 1) spraying components with an anti-rust solution (P/N 026-37707-000) or 2) disconnecting the belts and wrapping the sheaves and motor and sealing them with plastic. Insert a desiccant to absorb moisture that may penetrate the plastic protection.
- The fan motor windings should be megged at this time and recorded for comparison prior to placing in service.
- If the fan housing was supplied with a drain connection, this plug should be removed to prevent moisture from accumulating in this portion of the fan during storage.



Long-term storage is considered to be any period beyond six (6) months from date of shipment. If long-term storage is anticipated, contact Johnson Controls Sales representative at time of order entry for the proper instructions and requirements for long-term storage. Refer to Form 50.20-NM3.

PERIODIC FAN CHECK

On a monthly basis, the fan and motor should be rotated several times to replenish the bearing surfaces with fresh grease.

The fan impeller should be left at approximately 180 degrees from that of the previous month to prevent the belts from taking a set position.



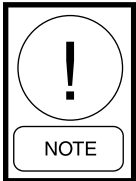
It will be the responsibility of the customer to submit a monthly log sheet (MS577) showing the condition of the unit and noting any discrepancies. A copy of the log sheet should be sent to the Johnson Controls Office, attn.: Sales Representative.



Failure to perform the long-term storage requirements will void the warranty.

| | | |
|---|---|----------------------|
|  BY JOHNSON CONTROLS | LONG-TERM STORAGE REQUIREMENT - FIELD PREPARATION AIR HANDLING UNITS | |
| SERVICE POLICY & PROCEDURES | Supersedes 50.20-NM3 (307) | Form 50.20-NM3 (909) |

**Failure to comply with these requirements will render
any written or implied YORK warranty null and void.**



Upon completion of the long term storage period, the warranty commences:

- *Solution - 18 months parts only. (not to exceed 36 months from ship date with delayed start up).*
- *Custom - 18 months factory parts (not to exceed 18 months from ship date).*
- *Labor 12 months only w/ delayed start up.*

I. Supplementary Documentation

The following documentation is required to FULLY COMPLY with the Long-Term Storage requirements.

- A. Long-Term Storage Requirements – GENERAL (refer to Form 50.20-NM1)
- B. Long-Term Storage – PERIODIC CHECKLIST AND LOGS,
AIR HANDLING UNITS (refer to Form 50.20-CL3).

II. Field Preparation for Long-Term Storage

A. GENERAL

1. Remove and dispose of shipping materials.
2. Perform a visual inspection of the equipment.

Indoor Units

It is Johnson Controls' intention that a shipping wrapper be applied to unpainted indoor units for protection from weather, road dirt, etc. during inland transit and that the wrapper be removed at the time of delivery to allow for a thorough inspection, both inside and out. Visible damage should be noted on the signed and dated bill of lading with a request that the carrier inspect the damage within 72 hrs of notification. The shipping wrapper must be removed and replaced with a tarp or similar protective covering. Any concealed damaged reported after 15 days will compromise a claim settlement. Inspection requests may be done by telephone or in person, but should be confirmed in writing. If assistance is needed with the claim process, contact your Johnson Controls Sales person.

Outdoor Units

Outdoor units are not fully wrapped. Exposed openings are covered for protection from weather, road dirt, etc. during inland transit. A thorough inspection, both inside and out, should be done at the time of delivery. Visible damage should be noted on the signed and dated bill of lading with a request that the carrier inspect the damage within 72 hrs of notification. Concealed damage must be reported within 15 days of delivery with a request that the carrier inspect the damage within 72 hrs of notification. Any concealed damaged reported after 15 days will compromise a claim settlement. Inspection requests may be done by telephone or in person, but should be confirmed in writing. If assistance is needed with the claim process, contact your Johnson Controls Sales person.

3. Touch up any paint that has worn or chipped off using paint supplied in ship loose items. Prepare the surface as required using a wire brush.
4. Verify that all ship loose items are present. Note any missing items on the Periodic Check List and Log Sheet (50.20-CL3).
5. Locate unit(s) so that passing traffic will not damage shafts, coil connections, damper linkages or unit panels.
6. Refrigerant coils must be evacuated and pre-charged with 5 PSIG nitrogen holding charge. DO NOT damage or disturb these coils and connections.
7. Water coils must have all inlet and outlet connections capped or closed tight to prevent foreign materials and liquids from gaining entrance during the storage period.


B. ELECTRICAL EQUIPMENT AND COMPONENTS (Control Panels, Power Panels, Option Panels, Motors, etc.)

1. Electrical Equipment and Components shall not be stored or left in an outdoor environment.
2. Electrical Equipment and Components shall not be stored or left in a wet or damp environment. Components sealed in plastic shrink-wrap are not exempt from this requirement. Moisture will collect inside the plastic, resulting in corrosion of the cabinet, the electronic components and/or copper bus bars.
3. Cortec® spray (Part VpCL-248) shall be applied to all components in the motor terminal box. The spray shall be applied to all exposed areas of concern.
4. YORK Vapor Emitter(s) shall be installed inside each electrical and electronic components cabinet(s) to protect against corrosion. Openings in cabinets shall be taped closed to minimize air infiltration during the storage period. The quantity of emitters is determined by measuring the gross volume of the component space occupied. YORK Part Number 026-37705-000 will protect a volume up to 5 cubic feet. YORK Part Number 026-37706-000 will protect a volume up to 11 cubic ft. Both emitters have a service life of 12 months.
5. A Vapor Type Corrosion inhibitor must be installed in the following equipment and components:
 - a. Place one corrosion inhibitor, YORK part number 026-37706-000, inside the power panel.
 - b. Place one corrosion inhibitor, YORK part number 026-37705-000, inside the control panel.
 - c. Place one corrosion inhibitor, YORK part number 026-37705-000, inside each VFD panel.

C. MECHANICAL

1. Spray all exposed shafts and sheaves with anti-corrosion spray, YORK part number 026-37707-007.
2. Disconnect belts and wrap all motors and sheaves in plastic with a YORK vapor emitter, part number 026-37705-000.



| | | |
|---|--|-----------------------------|
|  <p>BY JOHNSON CONTROLS</p> | <p>LONG-TERM STORAGE PERIODIC CHECKLIST AND LOGS AIR HANDLING UNITS</p> | |
| <p>SERVICE POLICY & PROCEDURES</p> | <p>Supersedes: 50.20-CL3 (507)</p> | <p>Form 50.20-CL3 (909)</p> |

| | | | |
|---------------|-------|-----------------------------|-------|
| Contract No. | _____ | Date Delivered | _____ |
| Job Name | _____ | Date of Storage Prep. | _____ |
| Serial No | _____ | Condition of Unit Delivered | _____ |
| Unit Model No | _____ | Explain: | _____ |
| | _____ | | _____ |
| | _____ | | _____ |
| | _____ | | _____ |

Failure to comply with these requirements will render any written or implied Johnson Controls warranty null and void.

I. Supplementary Documentation

The following documentation is required to FULLY COMPLY with the long term storage requirements.

- A. Long-Term Storage Requirements - GENERAL (refer to Form 50.20-NM1).
- B. Long-Term Storage Requirement - LONG -TERM STORAGE REQUIREMENT FIELD PREPARATION, AIR HANDLING UNITS (refer to Form 50.20-NM3).

II. Checks

1.0 Monthly Checks

- 1.1 Visually inspect Air Handler for damage.
 - 1.1.1 Motors/Drives - The motors and sheaves should be inspected externally for evidence of damage to the protective covering. An inspection is necessary only if it is apparent that the control protection has been disturbed. If this is found, the motor should be re-protected by wrapping and tightly sealing the control with plastic and inserting a desiccant to absorb moisture.

- 1.2 Refrigerant Coils - Check holding charge pressure monthly to be sure that the pressure has not dropped. If pressure has dropped, the unit should be inspected for signs of visible damage which may have caused the loss of pressure. If pressure drops more than 2 psi, the unit should be pressure tested to locate the leak, the leak repaired, and the unit recharged with nitrogen to 5 psig pressure. Note this in the comments section of the monthly log sheet (see page 2 of this document).

- 1.3 Rotate fan shaft several revolutions by hand every month.

2.0 Quarterly Checks

- 2.1 Complete Assembly - The unit should be checked quarterly to see that no damage has occurred to the protective covering. Any apparent damage to the covering or units should be noted in the comments section of the quarterly log sheet (see page 3 of this document).
- 2.2 Grease bearings every three months. The greasing procedure is explained in the product service manual.

3.0 Semi Annual Checks

- 3.1 None

4.0 Annual Checks

- 4.1 Unwrap all electrical cabinets and install new Vapor Emitters (YORK P/N 026-37705-000); reseal.
- 4.2 Re-spray all exposed shafts and sheaves with anti-corrosion spray, YORK P/N 026-37707-007.

| 1.0 Monthly | | | | |
|--------------------|----------------------|----------------------------|---|-----------------|
| | Rotate Shafts | 5 PSI Coil Pressure | Motor Belts & Drives Protected and Dry | Comments |
| Date | | | | |
| Initial | | | | |
| Date | | | | |
| Initial | | | | |
| Date | | | | |
| Initial | | | | |
| Date | | | | |
| Initial | | | | |
| Date | | | | |
| Initial | | | | |
| Date | | | | |
| Initial | | | | |
| Date | | | | |
| Initial | | | | |
| Date | | | | |
| Initial | | | | |
| Date | | | | |
| Initial | | | | |
| Date | | | | |
| Initial | | | | |
| Date | | | | |
| Initial | | | | |
| Date | | | | |
| Initial | | | | |
| Date | | | | |
| Initial | | | | |

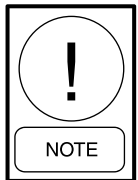
| 2.0 Quarterly | | | |
|----------------------|------------------------|------------------------------------|-----------------|
| | Grease Bearings | Inspect Protective Covering | Comments |
| Date | | | |
| Initial | | | |
| Date | | | |
| Initial | | | |
| Date | | | |
| Initial | | | |
| Date | | | |
| Initial | | | |

| 4.0 Annual | | | |
|-------------------|-----------------------------------|--|-----------------|
| | Install New Vapor Emitters | Re-spray Exposed Shafts and Sheaves | Comments |
| Date | | | |
| Initial | | | |

2.0 INSTALLATION



Do not weld or use torches on the exterior or interior of the unit housing. The housing contains polyurethane insulation, which under combustion will produce harmful, toxic gases resulting in personal injury or death.



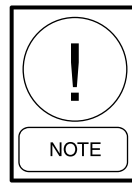
This instruction is written to provide general information. The product line allows many variations and the installer is fully responsible for adjusting his actions as needed. If any questions regarding the content of this manual, or if any information is not covered, contact local Johnson Controls Service.



Surface must be level on all installations.



If your unit has HEPA filters the filter frames, filter bulkheads and filter segment panels are factory sealed and must remain sealed for NO air bypass.



Never use silicone caulk/sealant or caulk/sealant containing silicone in or on any air handling equipment. [Only exception is when provided (high temperature) with gas heat venting].

SITE PREPARATION

OUTDOOR UNITS (SITE PREP)

Location of unit(s) should be away from building flue stacks or exhaust ventilators to prevent possible introduction of contaminated air through the outside air intakes (see Fig. 2-1 for service clearances).



Allow sufficient space around the unit for removing the access panels and various parts of the unit. A minimum clearance equal to the width of the unit must be provided on one side of the unit for removing the coil or fan assembly. Add dimension of pipe chase, air hoods, ducts, control/electrical panels, etc. to minimum clearances. Allow additional clearance as required by local and national codes. Consider Coil Access Panel for coil removal on outdoor units.

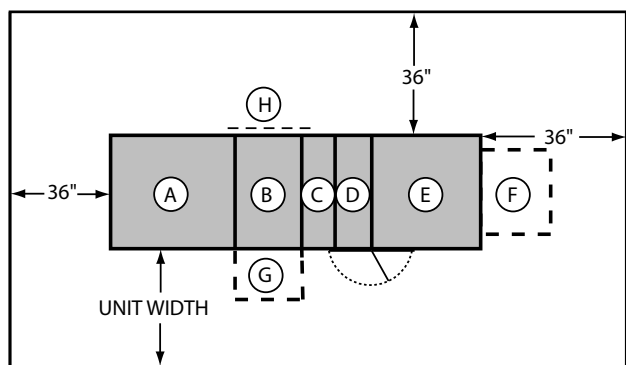


FIG. 2-1 – MINIMUM SERVICE CLEARANCES

MIN. CLEARANCE DIMENSIONS

- (A) Fan Section
- (B) Coil Section
- (C) Face and Bypass Damper Section
- (D) Filter Section - Door should open 180°
- (E) Inlet Section
- (F) Rain Hood (add to unit width or length)
- (G) Pipe Chase Enclosure (add to unit width)
- (H) Coil Access Panel on Outdoor Unit (allow clearance = to unit width)

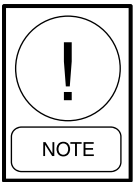
LD6328-4

MOUNTING

Units must be installed in such a manner as to provide enough elevation for properly designed condensate traps (see Section 2 “Drain - Condensate Drain Trap”). ►



Installation Site: Area of roof on which curb is to be installed must be structurally adequate to support the combined weight of curb, unit and system fluids. With these combined weights in place, the resting surface for the unit MUST be flat and level.

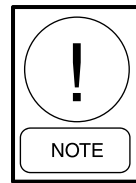


Concrete pads often are not as flat as they should be. Shimming and/or grouting may be necessary. Whether under the unit base or under the curb, this is to ensure the unit base is on a perfectly flat plane.

CURB

The curb, which supports the unit, will be shipped unassembled. It will be necessary to assemble the curb parts on the job site. Assembly drawing and a hardware package are shipped with each curb package. It is important the curb be installed square. If applicable, ensure pitch orientation is correct.

This “Curb Assembly & Installation Instruction” is typical. Use it in conjunction with the specific drawing supplied with each curb.



Should there be any questions as to the number of pieces of curb parts or assembling of the curb, notify Johnson Controls immediately.

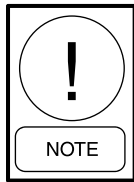
Curb, nailer, and gasket are supplied. All other parts such as wood or fiber cant strips, roofing felts, roofing material, caulking and curb-to-roof fasteners are to be field supplied.

Be sure the supporting structures will not obstruct the duct, piping or wiring connections.

Curb Assembly & Installation Instructions

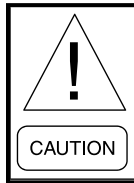
See Fig. 2-2

1. Unpack shipping package, layout pieces and parts according to the exploded views and check against Bill of Materials.
2. Layout all channel pieces as shown. Make certain that all channel tabs are located on inside of mating channel



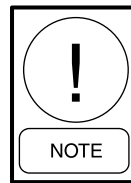
Make certain that all curb walls accessories and flanges, which may have been distorted in handling, are straightened before assembly.

3. Attach curb walls together to form rectangular perimeter as shown, leaving bolts loose.



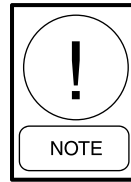
After the curb is set in place, ensure proper consideration has been given to the air duct openings through the roof.

4. The curb installation drawing (see Fig. 2-2) shows a gasket that is mounted between the curb and the unit. This gasket is shipped with the curb parts. Install the curb gasket before setting the unit on the curb. The gasket forms an air seal between the unit and the curb and serves as a dampener, preventing metal-to-metal contact between the unit and curb. However, the gasket should not be used as a vibration isolator where the prevention of noise and vibration transmission into the building is critical.



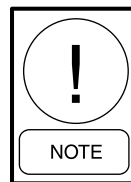
When unit is shipped in sections, the curb gasket is to be replaced with caulk provided by contractor.

5. After verifying curb is square and level, tighten all bolts and then anchor as appropriate.



If bolts are tightened after anchoring, curb will be pulled, twisted and torqued out of square.

6. Pipe Chase Curb Assembly - once curb is square and level mark the exact location for the pipe chase curb. Drill and assemble.

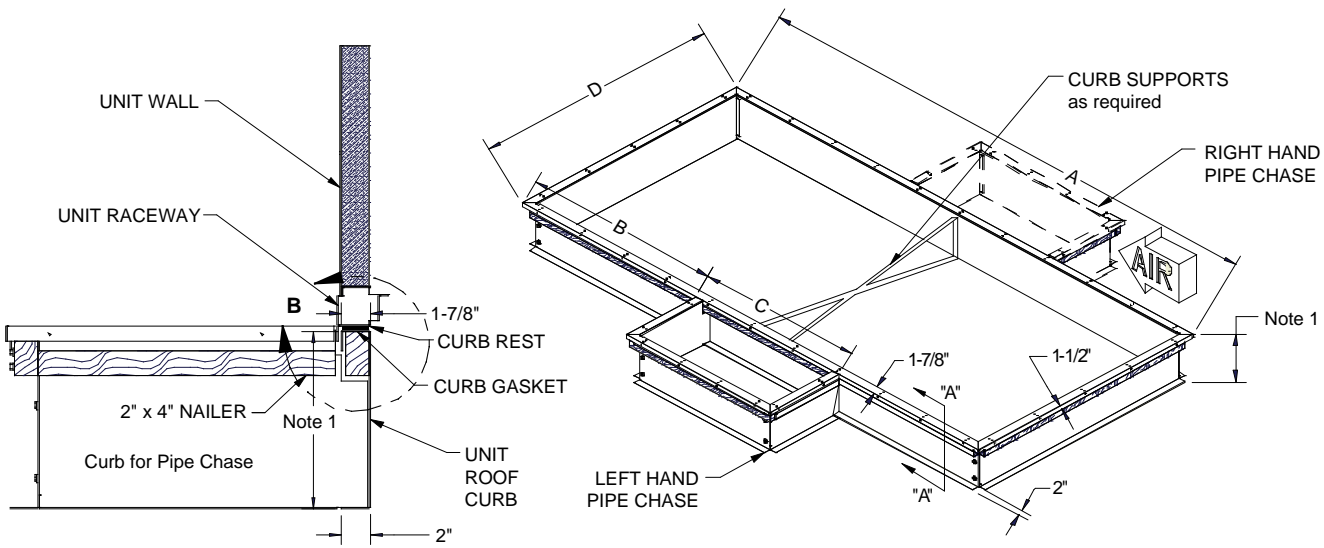


***Pipe Chase Curb Location:
Unit submittal drawing package has a Johnson Controls curb drawing showing dimensions of curb and pipe chase..***

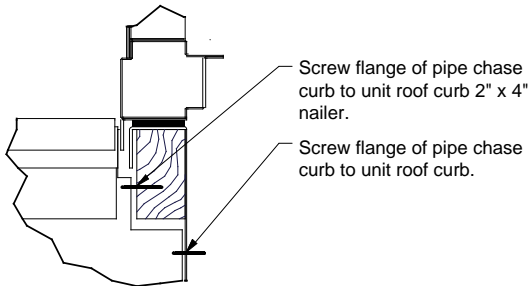
7. The curb should be insulated and roofed as required. Refer to SMACNA for counter flash.

STEEL FRAME

When a steel frame is used to support the unit, it must be level, flat without uneven steel frame joints, and support the unit around the full perimeter. As a general rule, cross members should be placed every 96" in addition to every shipping split.



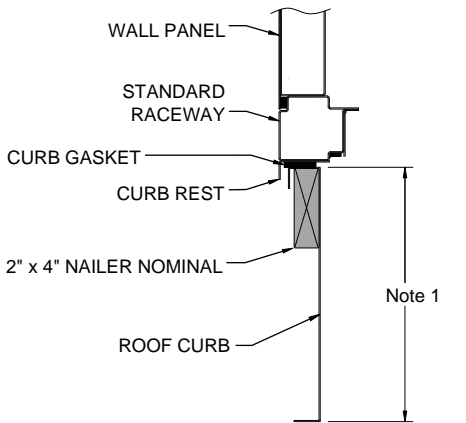
PIPE CHASE SECTION VIEW SECTION "A-A"



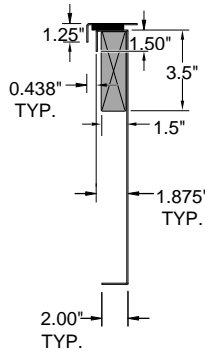
DETAIL B
PIPE CHASE CURB CONNECTION TO UNIT CURB

CURB CALCULATION FOR OUTSIDE DIMENSIONS

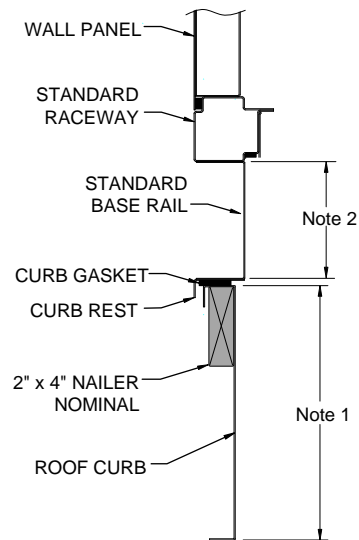
- A = Total unit length from YORKworks minus 0.875"
- B = Pipe chase location distance from unit discharge end.
Pipe chase Mtg. holes will not be included on the pipe chase curb. Mtg. will be field located.
- C = Pipe chase length minus 0.875"
- D = Total unit width from YORKworks minus 0.875"



TYPICAL CURB SECTION FOR UNITS W/O BASE RAIL



DIMENSIONS



TYPICAL CURB SECTION FOR UNITS WITH BASE RAIL

Notes:

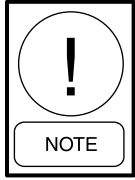
1. Curbs available in 14", 18", 22", 26", 30" & 34" heights
2. Outdoor Base Rails are available in 6", 8" & 10" heights.
Contractor is responsible for providing ductwork to include Base Rail height.

3. Curb material is galvanized steel, unpainted, and may vary in gage based on the unit load and the Qty. of cross bracing provided.
4. If curb space used as plenum, Seal all joints and seams with suitable sealer such as urethane caulk (YORK P/N 013-02966-011)

LD09616G

FIG. 2-2 – TYPICAL CURB ASSEMBLY

INDOOR UNITS (SITE PREP)



Concrete pads often are not as flat as they should be. Shimming and/or grouting may be necessary. This is to ensure the unit base is on a perfectly flat plane.

CLEARANCE



Allow sufficient space around the unit for removing the access panels and various parts of the unit. A minimum clearance equal to the width of the unit must be provided on one side of the unit for removing the coil or fan assembly.

MOUNTING

Units must be installed in such a manner as to provide enough elevation for properly designed condensate traps.

See Section 2 “Piping Connections - Condensate Drain Trap.” ▶

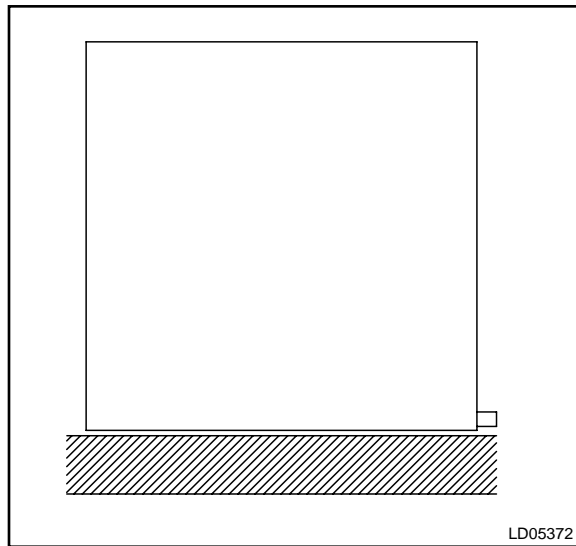


FIG. 2-3 – NO BASERAIL – HOUSEKEEPING PAD REQUIRED TO ACCOMMODATE TRAP HEIGHT

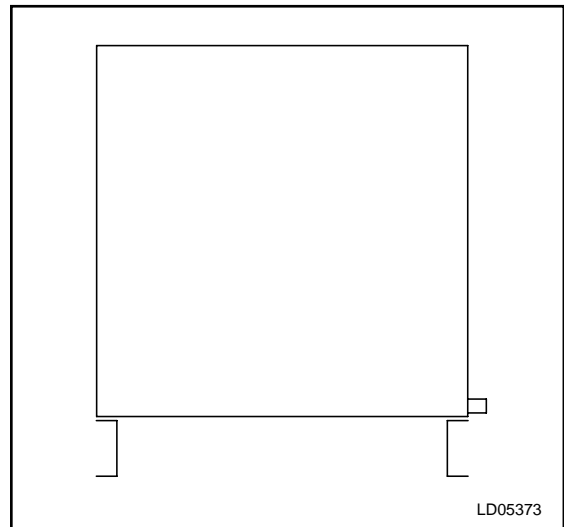


FIG. 2-4 – NO HOUSEKEEPING PAD – BASERAIL REQUIRED TO ACCOMMODATE TRAP HEIGHT

FLOOR

The floor must be flat and level.

HOUSEKEEPING PAD

The housekeeping pad must be flat and level (see Fig's 2-3, 2-4 & 2-5).

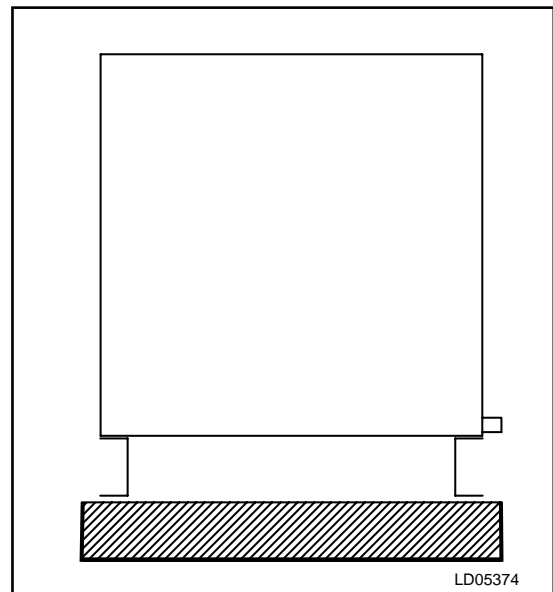


FIG. 2-5 – WITH BASERAIL AND HOUSEKEEPING PAD

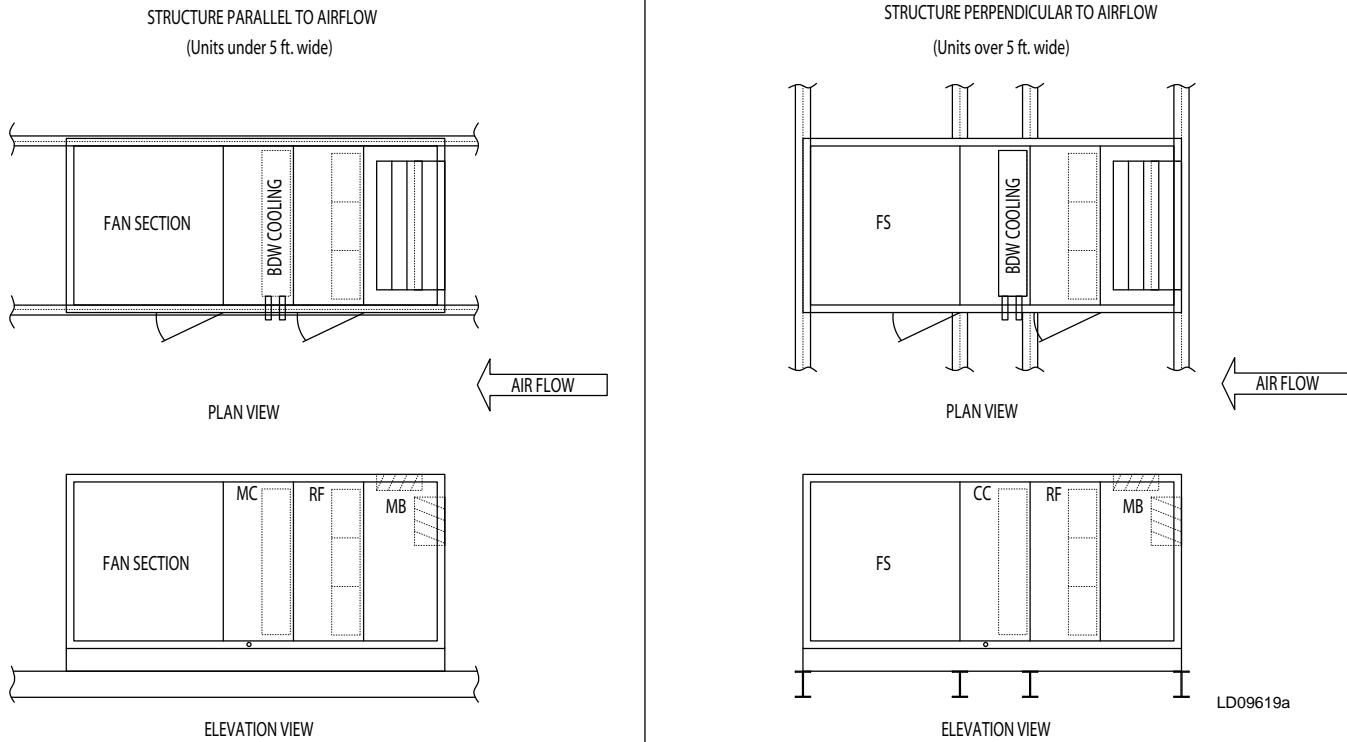
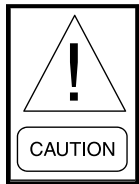


FIG. 2-6 – CEILING SUSPENDED UNIT

CEILING SUSPENDED UNITS



It is recommended that support is structurally engineered to prevent flexing, sagging or twisting of air handlers.

Refer to Fig. 2-6 “Ceiling Suspended Unit” for proper support of unit in the direction of airflow and/or perpendicular to the direction of airflow.

General Requirements

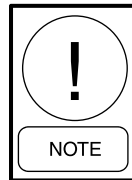
Johnson Controls recommends that ceiling suspension of units be accomplished in the field with the following:

Structure Positioned Perpendicular to Airflow

The units must be supported (at a minimum) in the following locations:

- Both ends.
- At each shipping split.

- Upstream and downstream of each cooling coil segment.
- Under heavy components like fans, attenuators, & heating segment.



Do not obstruct door operation, filter access, piping, electrical or control connections with suspension members.

Structure Positioned In the Direction of Airflow

The unit base must be supported continuously, on both sides of the unit.

UNIT INSTALLATION

TOOLS NEEDED

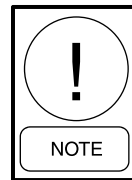


LD09613

FIG. 2-7 – TOOLS TYPICALLY USED FOR ASSEMBLY OF SHIPPING SPLITS

See Fig. 2-7.

- Drill with adjustable torque.
- No. 3 Phillips bit.
- Allen wrench set.
- Nut setter - Sizes 1/4", 5/16", 3/8" and 9/16" or socket set.
- Wire cutters.
- Power pulls or come-a-longs.
- Slings.
- Pry bar.
- Drift pins and awls.
- Common hand tools.
- Caulking gun.



Material not provided by YORK. When unit is shipped in sections, the gasket provided with the curb is to be replaced with caulk provided by contractor. Gaskets on curbs can pose a problem when sliding sections together for the final connection of each shipping split.

SHIP LOOSE PARTS

Look for label “Installation Instructions and Ship Loose Items Inside”. This label is normally located on the access door of the first fan section in the air stream. Only the parts listed in this section which are required for your unit are included.

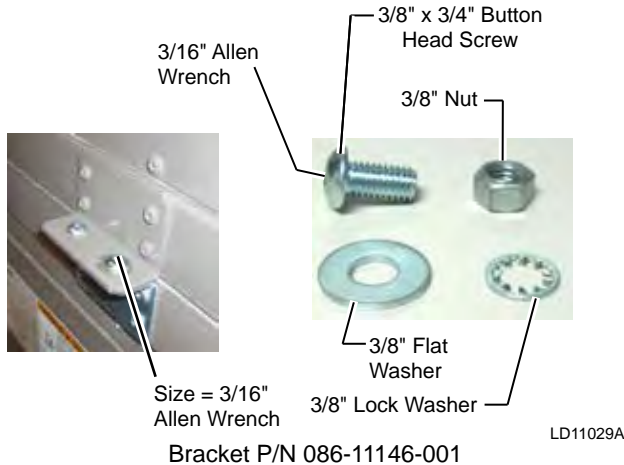
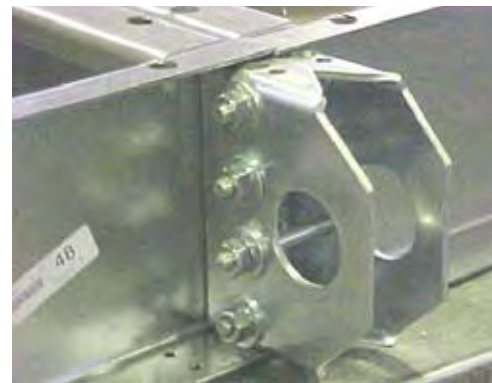


FIG. 2-8 – SECOND TIER TIE-DOWN FASTENER PACK
P/N 386-03419-000 (4 each per pack)



Baserail Lifting Lugs Assembled

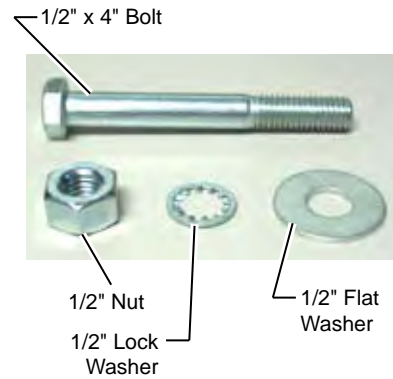


FIG. 2-10 – BASERAIL SHIPPING SPLIT FASTENER PACK
P/N 386-03417-000 (4 each per pack)



Raceway Lifting Lug (at shipping split)

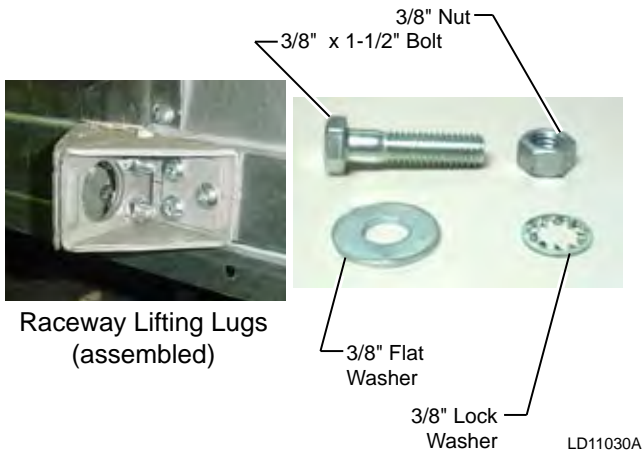
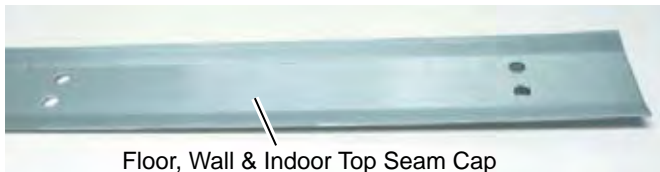


FIG. 2-9 – BOTTOM RACEWAY SHIPPING SPLIT FASTENER PACK
P/N 386-03418-000 (4 each per pack)



FIG. 2-11 – TOP RACEWAY SPLIT FASTENER PACK
P/N 386-04747-000 (2 each per pack)



Floor, Wall & Indoor Top Seam Cap



SEAM CAP

- 1/4" x 2" Neoprene Gasket, P/N 028-15954-010
- 1/4"-14 x 1" Phillips Pan Head Tek Screw, P/N 021-19560-000
- 1/4"-14 x 1" Hex Head w/ Washer & Gasket Tek Screw P/N 021-30530-052 for Outdoor Wall.



Roof Seam Cap (Outdoor)



ROOF SEAM CAP

- 1/4" x 2" Neoprene Gasket, P/N 028-15954-010
- 1/4"-14 x 1" Hex Head w/ Washer & Gasket Tek Screw P/N 021-30530-052 for Outdoor Roof.

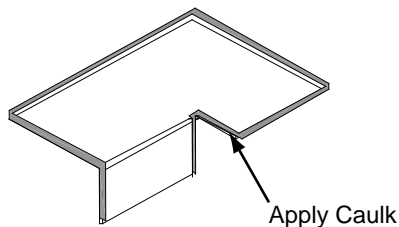
Apply 2" Gasket & Caulk



PIPE CHASE

- 1/4" x 2" Neoprene Gasket, P/N 028-15954-010
- 1/4"-14 x 1" Hex Head w/ Washer & Gasket Tek Screw P/N 021-30530-052

Apply 2" Gasket & Caulk



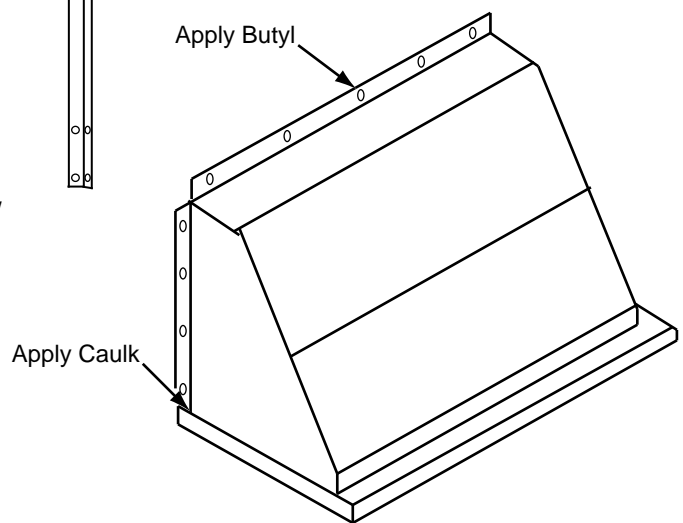
PIPE CHASE BASERAIL COVER
P/N 086-23998-001

PIPE CHASE TRIM ANGLE

- 1/4"-14 x 1" Hex Head w/ Washer & Gasket Tek Screw P/N 021-30530-052
- 1/4" x 2" Neoprene Gasket, P/N 028-15954-010



Apply Butyl



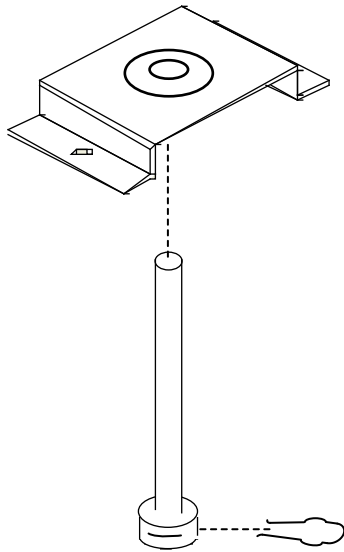
Apply Caulk

HOOD

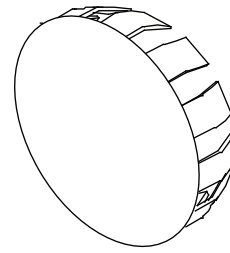
- 1/4"-14 x 1" Hex Head w/ Washer & Gasket Tek Screw
- 3/16" x 3/4" Butyl Tape

LD13770A

FIG. 2-12 – PIPE CHASE, HOODS & SEAM CAPS



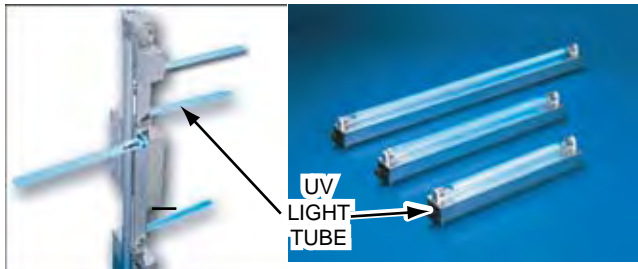
DAMPER SHAFT EXTENSION KIT
P/N 026-33715-002



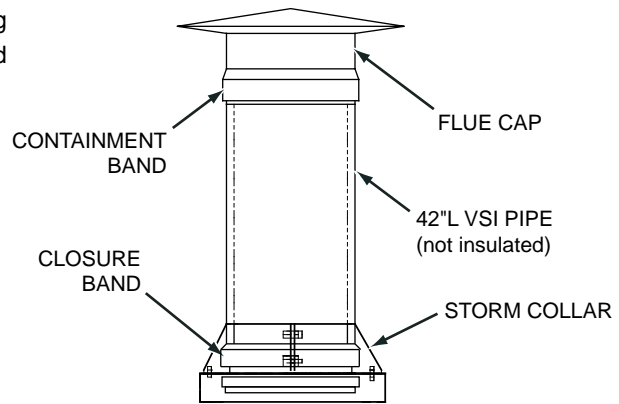
CORNER CONNECTOR HOLE PLUG
P/N 021-19568-000

HUMIDIFIERS

Optional Steam humidifiers, when selected are provided with dispersion equipment factory mounted inside the air handling unit. The steam injection or generating equipment, metering devices & sundries are shipped loose.



UV LIGHT TUBES to be installed by contractor.



GAS FURNACE FUEL VENTING PARTS



DO NOT touch UV Lamps (tubes) with bare hands or leather gloves as oils will damage the tubes. Use clean cotton rags, clean jersey or latex gloves to handle the lamps (tubes).

LD13788

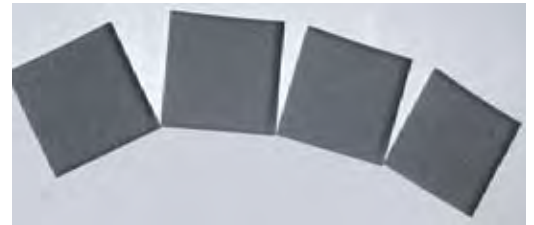
FIG. 2-13 – MISCELLANEOUS PARTS FOR OPTIONS



POLYURETHANE CAULK
 P/N 013-02966-011 GREY,
 P/N 013-03317-040 CHAMPAGNE



12 OZ. TOUCH-UP SPRAY
 P/N 013-03322-000



1/4" X 3-1/2" X 3-1/2" SHIPPING SPLIT
 CORNER GASKET
 P/N 028-11883-010
 (Outdoor Only)



Never use silicone caulk/sealant or caulk/sealant containing silicone in or on any air handling equipment. [Only exception is when provided (high temperature) with gas heat venting]



1/4" X 3/4" X 35' NEOPRENE
 GRAY GASKET
 P/N 028-11873-010



1/4" X 2" X 25' NEOPRENE GASKET
 P/N 028-15954-010



3/16" X 3/4" X 40' BUTYL TAPE
 P/N 013E-03327-010



1/4"-14 X 1"
 PHILLIPS PAN HEAD
 SELF DRILLING SCREW
 P/N 021-19560-000



SPARE FAN BELT
 (Attached to Fan)



1/4"-14 X 1"
 HEX HEAD
 SELF DRILLING SCREW
 W/ EDPM WASHER
 P/N 021-30530-052

LD13771

FIG. 2-14 – HARDWARE, GASKETING, CAULK, PAINT AND TAPE

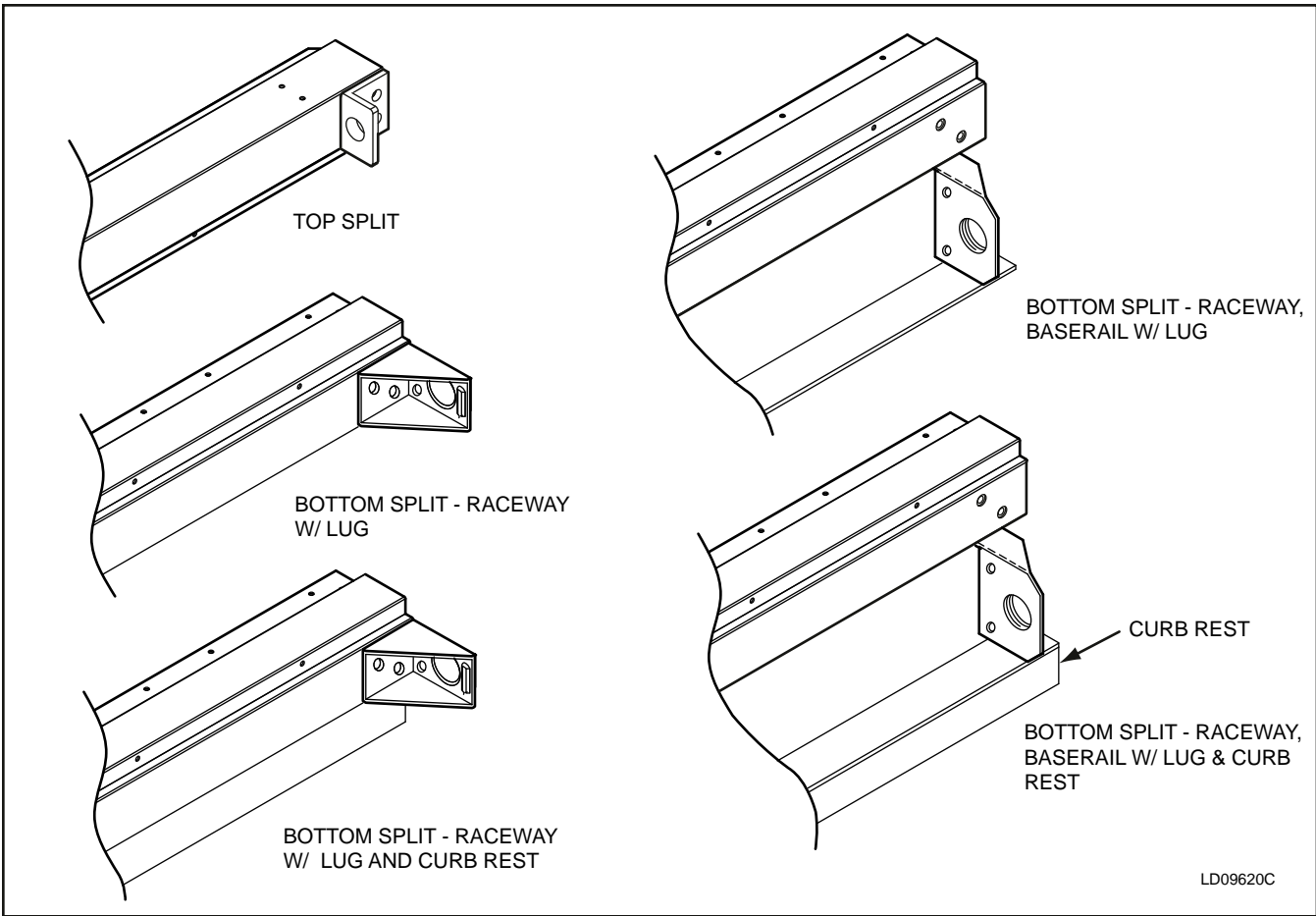


FIG. 2-15 – SHIPPING SPLIT EXAMPLES

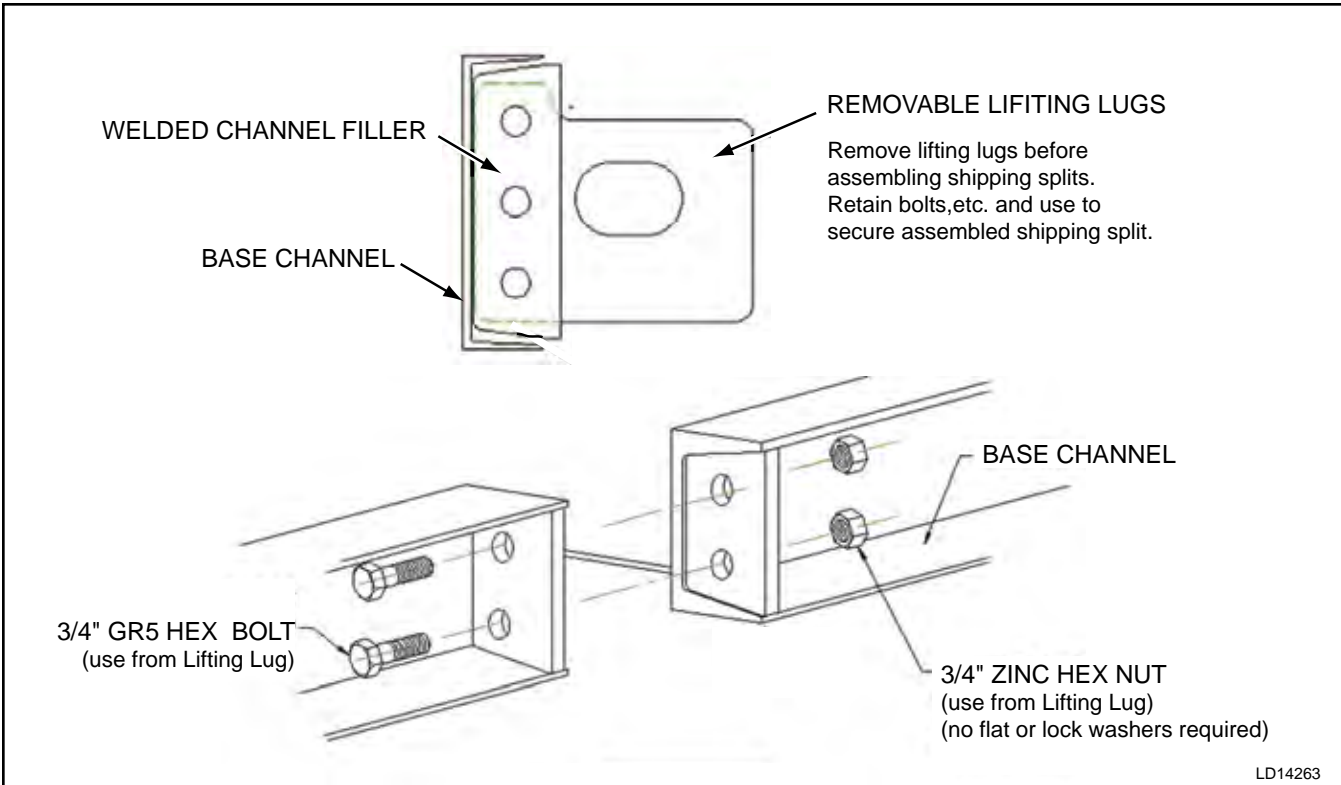
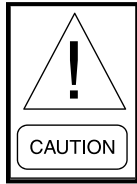
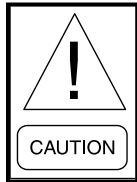


FIG. 2-16 – SHIPPING SPLIT EXAMPLES FOR EXPANDED CABINET

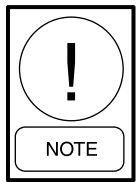
ASSEMBLY OF OUTDOOR UNIT



See rigging suggestions and details in Section 1. ►



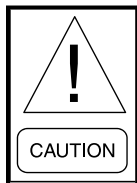
Do not damage factory installed pipe chase, electrical cabinet, hoods, pipe stubs, door handles or roof overhang.



See “Ship Loose Parts” to identify gaskets and hardware items.

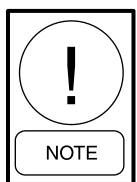
INSTALLING SINGLE PIECE OUTDOOR UNIT

1. Units should not be moved on a roof surface but should be lifted from the ground onto the curb or support framework. Remove the wood shipping material from bottom of unit.



The curb gasket, which is provided, must be installed before the unit is lowered onto the curb. The gasket is shipped with the curb package.

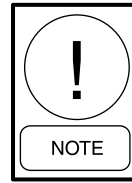
2. SEAL (to curbing): When setting the unit onto the curb, the installer should ensure that a sealing gasket is positioned between the unit and curb to provide a continuous airtight and watertight connection.
3. Installation should be in accordance with local code requirements.



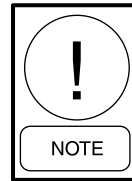
When installing on steel or slab, eliminate seal unless specified.

INSTALLING MULTIPLE PIECE OUTDOOR UNIT

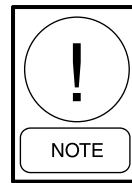
See Fig. 2-15 & 2-16 for Shipping Split Examples.



If applicable, remove metal bracket screwed to the cross channel and wood shipping blocks before assembling shipping splits.



When unit is provided with shipping splits, use construction grade caulk (not provided) in place of curb top gasket. Apply the caulk on top of curb just before each section is placed on the curb. Apply the caulk with a 1/2" diameter bead to assure seal after sections are pulled together. Positive seal must be achieved. Disregard this note if shipping splits are assembled prior to placing the unit on curb.



If assembly is done prior to setting unit sections on a curb, be sure to have units on a flat surface during the assembly process. Do not remove shipping blocks from under unit until assembled unit is ready to be lifted and placed.



Make sure top of curb is flat and shims added where/if needed to ensure curb will remain flat.

1. Before placing sections on the curb:
 - a) Verify the correct sections and orientation of each section.
 - b) Remove cross brace(s) (shipping supports) from each section's shipping split.
 - c) Remove plastic shipping covers and their supports.
 - d) Remove screws from curb rest to release wood shipping blocks. Leave blocks under unit sections until lifted. Be sure that no debris clings to the bottom of each section when lifted for placement.

- e) Make sure all wiring and/or control tubing connection pig tails are secured out of the path of the shipping split mating surfaces to prevent damage.
- f) Apply 3.5" x 3.5" separate gasket squares, placing one square at each corner of the face of one section. Apply 1/4" x 2" foam gasket to face perimeter from 3.5" square to 3.5" square. Apply this gasket 1/4" from outside edge of mating surface (nearest to exterior of air handler). This is to allow for a 1/4" bead of caulk. Refer to Fig. 2-17.

Butt joints to raceway gasket.
Caulked at joints.



The gasket application should provide a continuous seal from side to side and the top of the unit roof to the bottom of the unit base where it meets the curb.

LD13372

FIG. 2-17 – APPLYING GASKET

- g) Apply a 1/2" thick bead of caulk (not provided), to curb top surface only where the first section will be placed.
2. Place the first section on the curb while positioning it so that the overhanging curb rest is spaced evenly from the curb on each side and end.
 3. After the first section is placed in position, anchor or block it before setting the next section.
 4. Attach power pulls or come-a-longs to the first section. Use lifting lugs on the base rail (not at the shipping split) or holes in the two outside corners.
 5. Apply a 1/2" thick bead of caulk to curb top surface only where the next section will be placed, plus about 4".

6. Place the next section on the curb about 4" from the section already placed.
7. At this time feed the electrical and control connections from section to section and ensure that they will be accessible after the sections are joined. Assemble the electrical connectors and/or pneumatic tubes each according to their labels. Do this before joining sections if access will be a problem later. Refer to Fig. 2-18.

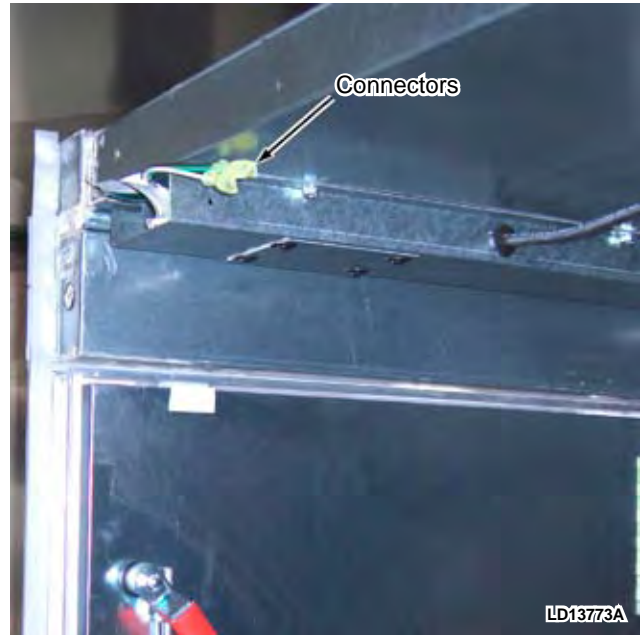
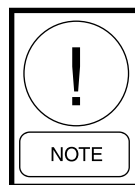
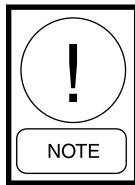


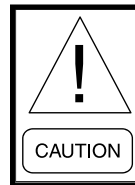
FIG. 2-18 – ELECTRICAL CONNECTIONS



All lighting and 3-phase wires must be hard wired when no plug-ins are provided.



After wiring connections are made and before proceeding with assembly, the top shipping split angle will need to be removed and repositioned (see Fig. 2-19).



Ensure chain does not apply pressure to drain connection. Improper positioning of chain may cause damage to unit.

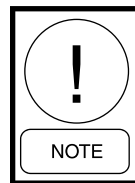


FIG. 2-19 – REMOVE AND REPOSITION SHIPPING SPLIT ANGLE

8. Attach the power pulls or come-a-longs to the far end of the next section.

9. Start pulling this section toward the first section. Pull evenly on both sides.
 - a) Be sure all of the electrical or control wires or tubes are clear.
 - b) Guide the top raceways together by placing rods or drift pins through the holes in the top guide angles. When the raceways are close enough, install the long bolts provided.
 - c) Guide the bottom raceways together using rods or drift pins through the bolt holes in the lifting lugs on opposite sections. Do this on each side of the unit simultaneously.
 - d) If any difficulty aligning due to racking of one section or the other, use another come-a-long diagonally on the inside of that section, at or close to the shipping split. Straps may be used across the unit roof.
 - e) If any difficulty due to top and bottom not pulling together evenly or simultaneously, the curb is probably not installed flat. Apply shims under the curb or roof decking to compensate for irregularities of the roof deck.

10. Complete pulling the sections together.



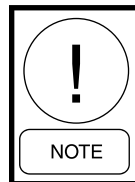
Use come-a-longs to pull the sections together. The bolts are to hold the sections tight after they are pulled together.

11. Fasten bottom lifting lugs together using 1/2" x 4" bolts provided.
12. Fasten top raceway bracket using 1/2" x 5-1/2" bolts.



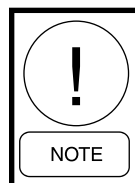
FIG. 2-20 – BRINGING SECTIONS TOGETHER

13. Apply a 1/4" bead of caulking to the exterior of the seam. Trowel the bead level with the air handler exterior. This is to be done on roof and both sides (*see Fig. 2-20*).
14. Apply 1/4" bead of caulking to the seam inside the unit on the floor.
15. Apply 1/4" x 2" foam gasket to the underside of the seam caps and install them over the joints using 1/4"-14 x 1" hex head screws provided. Painted seam caps are applied over the joints on the sides and roof of the exterior and galvanized seam caps are applied on the floor of the interior only.

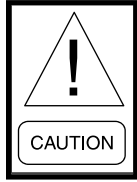


If a roof seam cap has a tab on one end only, the end without the tab goes above the pipe chase location.

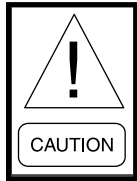
16. Repeat this procedure for each additional section to be placed in making up the complete unit.
17. Install 1-1/2" Corner Connector Plugs on bottom raceway corners.



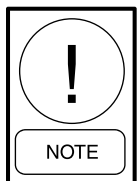
Only needed on units or sections without baserails.

ASSEMBLY OF INDOOR UNIT

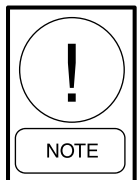
See rigging suggestions and details in Section 1. ►



Do not damage factory installed pipe chase, electrical cabinet, hoods, pipe stubs, door handles or roof overhang.



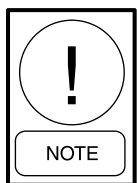
See “Ship Loose Parts” to identify gaskets and hardware items.



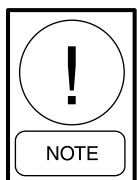
If the unit or unit sections are too large to fit through an opening, contact the local Johnson Controls office for assistance. Technical instruction is available for Disassembly and Reassembly.

INSTALLING MULTIPLE PIECE INDOOR UNIT

See Fig. 2-15 & 2-16 for Shipping Split Examples.



If applicable, remove metal tab screwed to the cross channel and wood shipping blocks before assembling shipping splits.



If assembly is done prior to placing unit sections, be sure to have sections on a flat surface during the assembly process.

1. Before placing sections:
 - a) Verify the correct sections and orientation of each section.
 - b) Remove cross brace(s) (shipping supports) from each section’s shipping split.

- c) Remove plastic shipping covers and their supports.
- d) Make sure all wiring and/or control tubing connection pig tails are secured out of the path of the shipping split mating surfaces to prevent damage.
- e) Apply 1/4" x 2" neoprene gasket material **TO ONE SIDE ONLY** of each shipping split. Be sure the entire perimeter is covered with gasket material, including the foamed corners. Any void, depression or protrusion will allow air or water leakage. Gasket must be continuous through the corners. Make any splices on a straight run. Refer to Fig. 2-21 & 2-22.

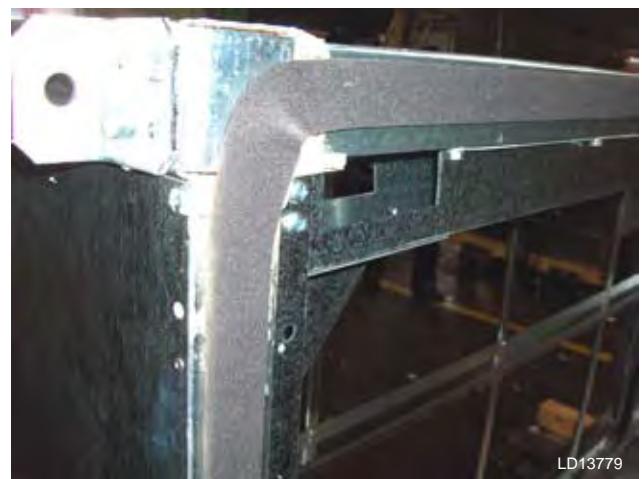


FIG. 2-21 – APPLYING GASKET TO SHIPPING SPLIT

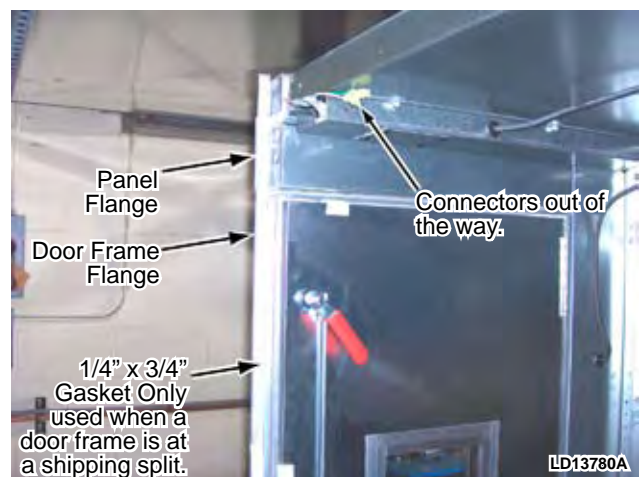


FIG. 2-22 – APPLYING GASKET TO DOOR FRAME WHEN AT SHIPPING SPLIT

- f) For expanded cabinet with end channel shipping split see fig. 2-23

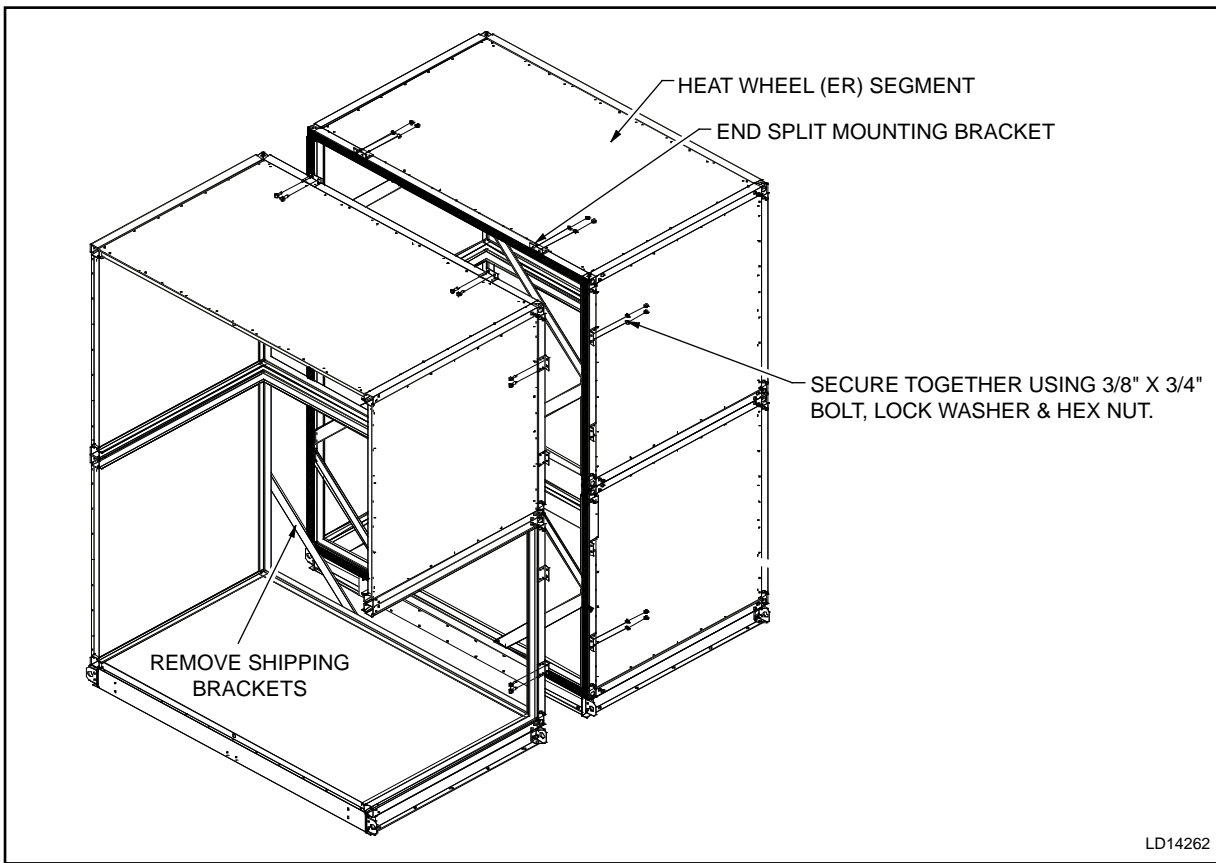
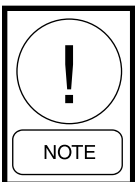


FIG. 2-23 – ASSEMBLY OF END CHANNEL SHIPPING SPLIT ((EXPANDED CABINET)

- Place the first section in its final position and anchor or block it before placing the next section (see Fig. 2-25).



After wiring connections are made and before proceeding with assembly, the top shipping split angle will need to be removed and repositioned (see Fig. 2-24).

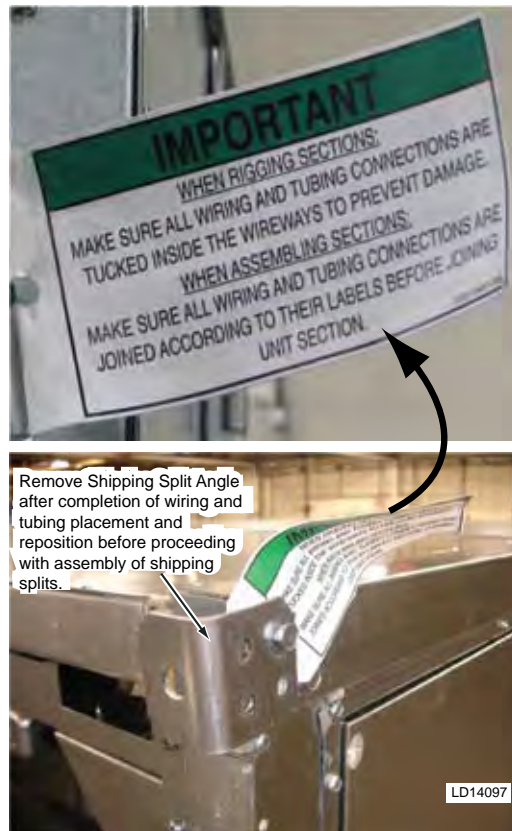


FIG. 2-24 – REMOVE AND REPOSITION SHIPPING SPLIT ANGLE

3. Attach power pulls or come-a-longs to the first section. Use the lifting lugs on base rail (not at the shipping split) or holes in the two outside corners (see Fig. 2-25).



FIG. 2-25 – PLACING & ANCHORING FIRST SECTION AND ATTACHING COME-A-LONGS

- 3A. For expanded cabinet with structural steel base remove lifting lugs within the shipping split. retain bolts and nuts (see Fig. 2-26)

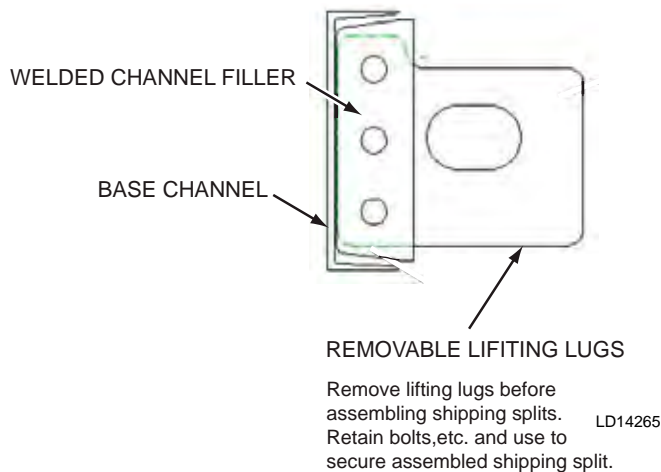


FIG. 2-26 – REMOVE LIFTING LUGS AND SAVE HARDWARE

4. Place the next section about 8" from the section(s) already placed.
5. At this time feed the electrical and control connections from section to section and ensure that they will be accessible after the sections are joined. If any will not be accessible, assemble the electrical connectors and/or pneumatic tubes each according to their labels before joining of sections is complete. Refer to Fig. 2-27.

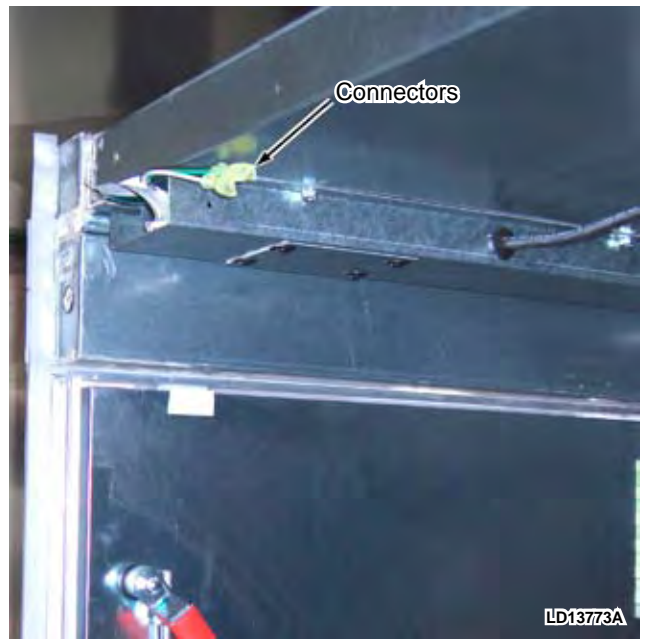
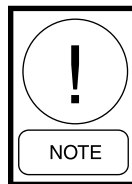


FIG. 2-27 – ELECTRICAL CONNECTIONS



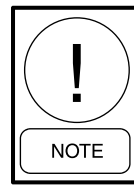
All lighting and 3-phase wires must be hard wired when no plug-ins are provided.

6. Attach the power pulls or come-a-longs to the far end of the next section.



Ensure chain does not apply pressure to drain connection. Improper positioning of chain may cause damage to unit.

7. Start pulling the sections together. Pull evenly on both sides.
 - a) Be sure all of the electrical or control wires or tubes are clear.
 - b) Guide the top raceways together by placing rods or drift pins through the holes in the top guide angles. When the raceways are together, install the long bolts provided.
 - c) Guide the bottom raceway/baserails together using rods or drift pins through the holes in the lifting lugs on opposing sections. Do this on each side of the unit simultaneously.
 - d) If any difficulty aligning due to racking of one section or the other, use another come-a-long diagonally on the inside of that section at the shipping split or across the tops of opposing sections..
 - e) If any difficulty aligning due to top and bottom not pulling together simultaneously, apply shims under the unit sections as needed to compensate for uneven placement area.
8. Complete pulling the sections together.
9. Fasten bottom, lifting lugs together with 1/2" x 4" bolts provided. *See Fig. 2-28.*
10. Fasten top raceway brackets with 1/2" x 5-1/2" bolts.
11. Apply 1/4" x 2" foam gasket to the underside of the seam caps and install them over the joints using 1/4"-14 x 1" hex head screws provided. Seam caps are provided for sides, top and floors.
12. Repeat previous steps for each additional section to be placed in making up the complete unit.
13. Install 1-1/2" Corner Connector Plugs in bottom raceway corners.



Only needed on units or sections without baserails.



Use come-a-longs to pull the sections together. The bolts are to hold the sections tight after they are pulled together.

FIG. 2-28 – INSTALLING BOLTS AFTER PULLING UNITS TIGHT TOGETHER

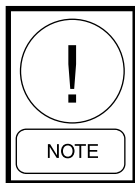


FIG. 2-29 – TIERED UNIT

LD09624



See complete rigging instructions explained in detail in Section 1.



See “Ship Loose Parts” in this section of the Manual to identify gaskets and hardware items.

INSTALLATION OF TIERED UNIT

A Tiered Unit may not be factory assembled. Field assembled units are shipped with the top-tier segment skidded. This top-tier segment is equipped with brackets bolted to the bottom raceway (see Fig. 2-30). The bottom-tier segment is equipped with brackets bolted to the top raceway.

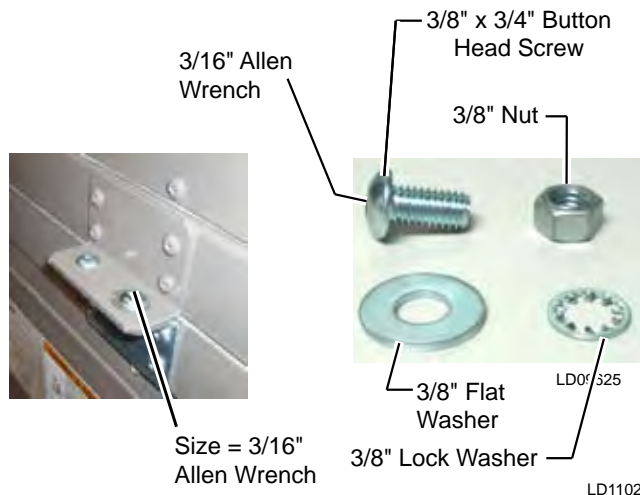


FIG. 2-30 – TIERED UNIT SECURED WITH BRACKETS

These brackets are used to secure the top segment to the bottom segment. After final alignment, bolt the two brackets with hardware supplied.

1. Before placing top tier:
 - a) Verify the correct orientation of top and bottom tier.
 - b) Remove cross brace(s) (shipping supports) from top tier.
 - c) Remove plastic shipping covers and their supports.
 - d) Make sure all wiring and/or control tubing connection pigtails are secured out of the path of the mating surfaces to prevent damage during rigging.
 - e) Ensure 1/4" x 2" neoprene gasket properly installed on bottom tier. If the top tier is shorter in direction of airflow than the bottom tier, apply gasket material on the top panel of the bottom tier from raceway to raceway but not on top of raceways (see Fig. 2-31).

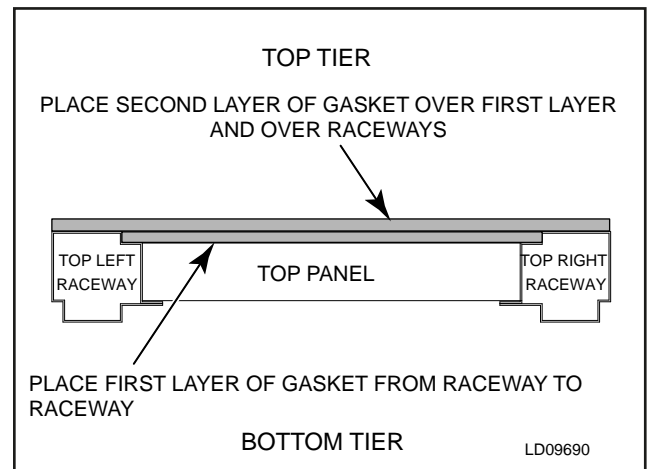


FIG. 2-31 – APPLY GASKETS TO TOP PANEL BOTTOM TIER

- f) Apply second layer of 1/4" x 2" gasket over top of that applied in step (e) but include the raceways. Steps (e) and (f) are necessary because the top panel of the bottom tier is slightly recessed below the height of its raceways.
- g) If top tier has shipping splits, refer to “Installing Multiple Piece Indoor Unit” for correct assembly procedure.



Be sure all of the electrical or control wires or tubes in both tiers are clear.

2. Install (4) shackles, one in each bottom corner connector or raceway lifting lug.
3. Fasten sling/chain to shackles.
4. Fasten other end of sling/chain to spreader bar (as needed).
5. Lift top tier assembly with crane or overhead lift.
6. At this time feed the electrical and control connections from top tier to bottom tier and ensure that they will be accessible after the sections are joined. If any will not be accessible, assemble the electrical connectors and/or pneumatic tubes each according to their labels before joining the top and bottom tier.

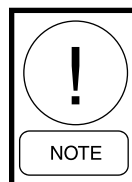
7. Lower the top tier onto bottom tier so that mounting brackets mate. Guide brackets together using rods or drift pins through the bolt holes (see Fig. 2-32).



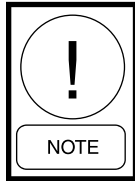
LD09626

FIG. 2-32 – GUIDING BRACKETS TOGETHER

8. Carefully place each section of the top tier without disturbing the gaskets on the bottom tier.
9. Secure the top tier to bottom tier with 3/8" x .75" Allen head bolts.
10. Install 1-1/2" Corner Connector Plugs in bottom raceway corners.

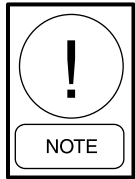


Only needed on units or sections without baserail



See "Ship Loose Parts" to identify gaskets and hardware items.

ASSEMBLY OF END CHANNEL SHIPPING SPLIT



The assembly is the same regardless of what sections are being connected together. The vertical Energy Recovery Wheel shown in Fig. 2-33 is a common example

Prior to pulling sections together:

1. Remove baserail support plate (large units).
2. Remove shipping brackets in corners.
3. Remove screws in raceway corners at ends of all segments joining together (as shown in Detail A of Fig. 2-33).
4. Clean the metal surface where gasket is to be applied with mineral spirits or rubbing alcohol.

5. Apply 1/4" x 2" neoprene gasket to all raceway mating surfaces of one mating section. Include two gaskets side by side on intermediate raceway surfaces (large units).
6. Ensure that the sections are not racked and will line up properly.

Attach sections as follows:

1. Make sure assembly surface is clean and level to allow the sections to slide freely. If surface is irregular, use metal shims under sections as necessary to align mating surfaces.
2. Pull sections together using a come along, drawing the base together.
3. Attach the sides of the sections. Beginning at the bottom of the sections secure the end channel assembly brackets together using 3/8" x 3/4" Allen head bolts, lock washers & hex nuts at each bracket. Continue securing the end channel assembly brackets together, working from bottom to top, pulling the sections tight.
4. After the sides are secured, secure the brackets on top of the unit with the same hardware mentioned in step 3.

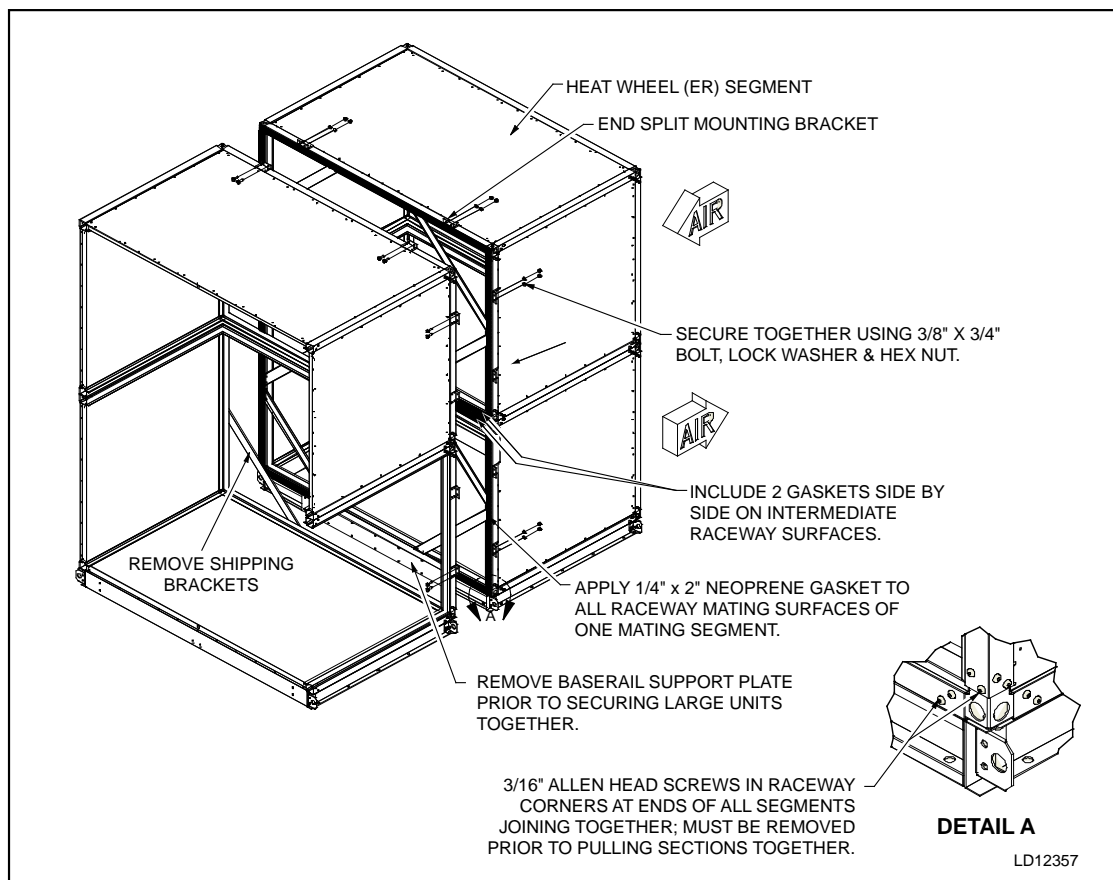


FIG. 2-33 – ASSEMBLY OF END CHANNEL SHIPPING SPLIT (ENERGY RECOVERY WHEEL SHOWN)

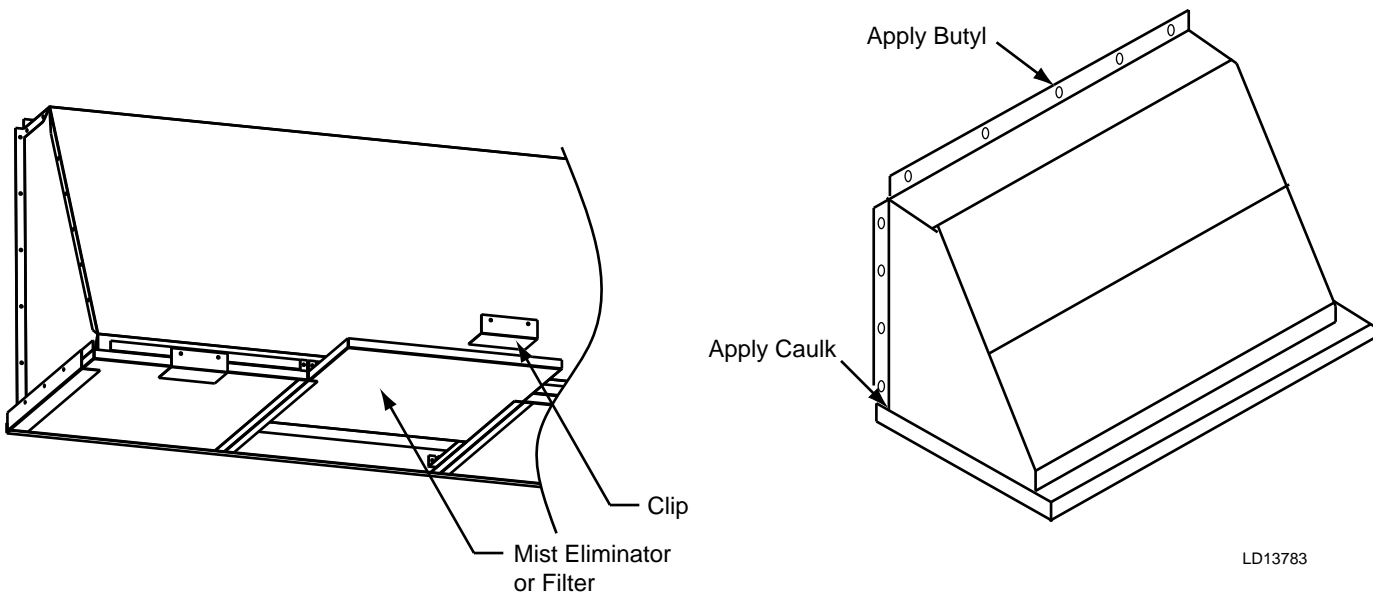
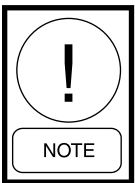


FIG. 2-34 – HOOD INSTALLATION WITH OPTIONAL MIST ELIMINATORS

HOOD INSTALLATION WITH OPTIONAL MIST ELIMINATORS



See “Ship Loose Parts” for identification of gaskets and hardware.

1. Identify correct hood and respective location (*see example on Fig 5 “Loose Component ID Labels” found in the Unit Identification section of this Manual*). Each hood is labeled for easy identification.
2. Correct orientation is with the tracks or bird screens to the bottom. The mounting flanges are predrilled.
3. Each hood is fitted with a factory installed bird screen unless mist eliminator option is selected.
4. Apply provided 3/16" x 3/4" Butyl tape to the predrilled hood flanges and back wall angle that contact the unit panels.
5. Use 1/4"-14 x 1" Hex Head Self Drilling Screws w/EPDM washer provided.
6. Each damper opening in the unit panels should be completely covered by its respective hood. The bottom of the hood should extend approximately 6" below the opening in the unit panel.

7. Each hood is to be centered over the width of the opening. All hoods, especially those containing barometric dampers, **MUST** be installed square.
8. Seal each hood gutter to the unit panel with Polyurethane Caulk provided.
9. When multiple hoods are installed in a stack space the hoods approx. 1.5" apart so the bottom hood will extend 6" below the bottom of the opening.
10. Install optional mist eliminators.
 - Remove the clip(s) from the leading edge of the hood.
 - Insert the proper size mist eliminator or filter into the tracks.
 - Reinstall the clip(s) on the leading edge of the hood.

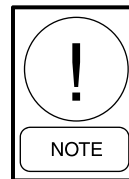
OUTDOOR AIR TEMPERATURE AND/OR HUMIDITY SENSORS

When Outside Air Hoods are shipped loose on units that include Factory Packaged Controls, these sensors will be dismantled and pulled back into the air handler. The contractor is to find them secured with tape inside and put them through their respective penetration to the exterior and mount them to the bracket provided.

ACTUATOR INSTALLATION

See Fig. 2-35

1. Remove the bearing plate from the damper frame and jackshaft.
2. Slide the damper actuator onto the open end of the shaft making sure that the proper spring return position on the face of the actuator matches the damper shafts rotation. If not, then reinstall the actuator with it flipped over.
3. Reinstall the bearing plate to the damper frame and jackshaft. Make sure spring hose clamps hold the jackshaft securely.
4. Slide the damper actuator mounting bracket into the actuator mounting grooves and fasten to the damper frame using self drilling screws.
5. Tighten the actuator shaft clamp to the damper jackshaft. Make sure at this point, the damper shaft is completely rotated to its proper position.
6. Manually operate the actuator to its fully actuated position using the crank arm provided with the actuator. Then release the spring to allow the damper to go back to its original position. This will verify the actuators spring rotation and stroke.
7. Set the damper actuators rotation selector switch to the proper rotation required to actuate the damper.



Damper actuator rotation will always be opposite the spring return rotation.

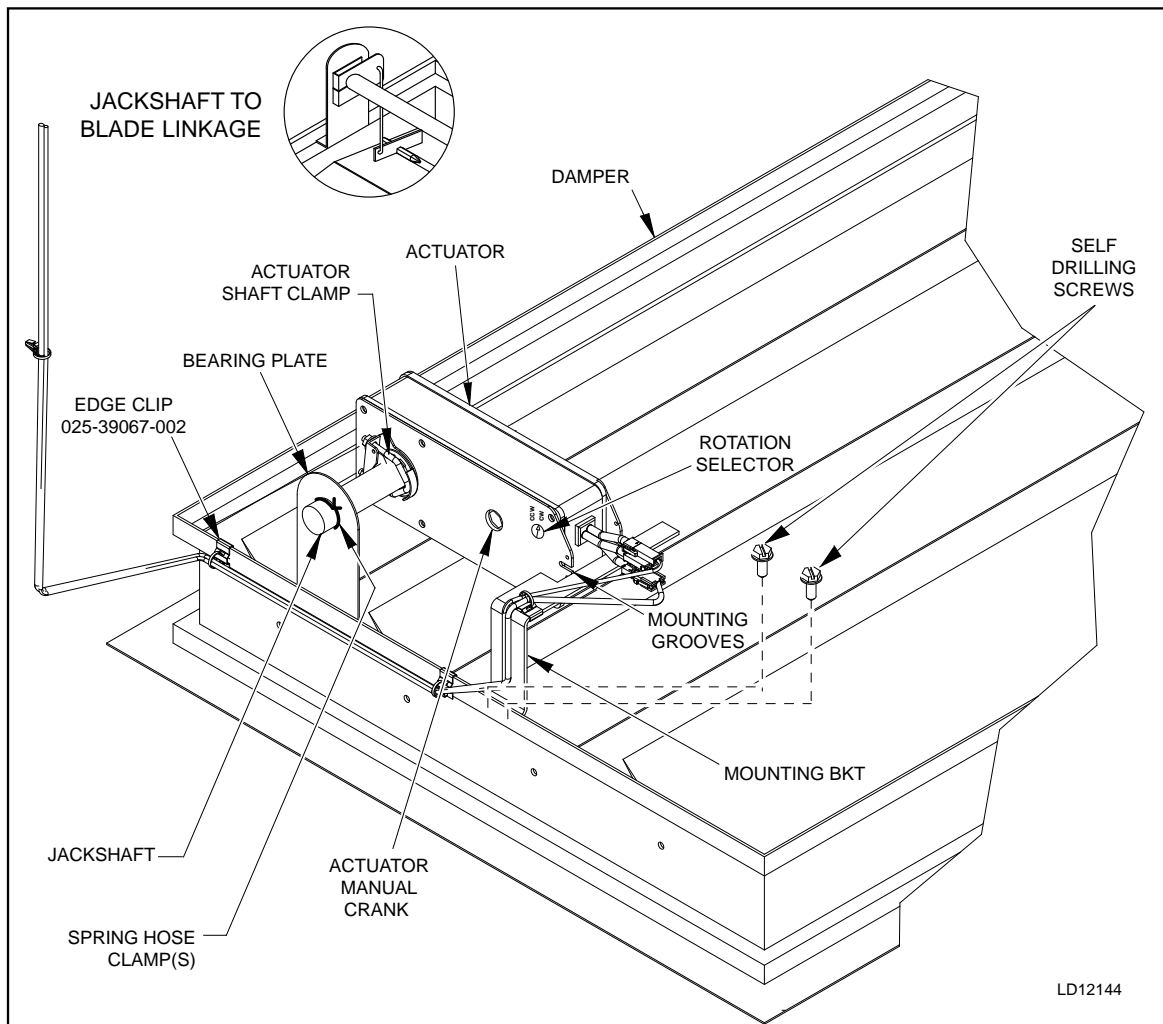
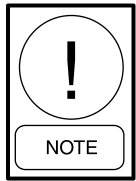


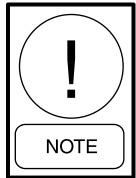
FIG. 2-35 – DIRECT COUPLED ON JACKSHAFT

INSTALLATION OF MULTIZONE (MZ) DAMPERS

See Fig. 2-36



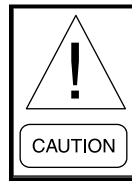
SHIPPED LOOSE MZ DAMPERS. If the MZ segment has a shipping split, a rear discharge (end of unit), and a multizone damper, then the multizone damper will be shipped loose.



See “Ship Loose Parts” to identify gaskets and hardware items.

DAMPER INSTALLATION

1. After the unit top tier is assembled to the unit bottom tier and sealed, install MZ damper assembly. The assembly includes both hot deck and cold deck damper banks, already connected at each blade.



Distortion will result in unreliable blade operation.

2. Remove 16 gauge shipping plate from air entering side ONLY. Plate is located between hot and cold decks.
3. Apply provided 1/4" x 2" neoprene gasket to the mounting flanges of the damper assembly.
4. Center the damper assembly over the discharge openings of the hot deck (top) and cold deck (bottom).
5. Attach the damper assembly to the unit outer perimeter mounting flange using 1/4"-14 x 1" self-drilling screws provided.
6. Remove 16 gauge shipping plate from air leaving side.
7. Install screws through mounting flanges found between hot and cold decks.

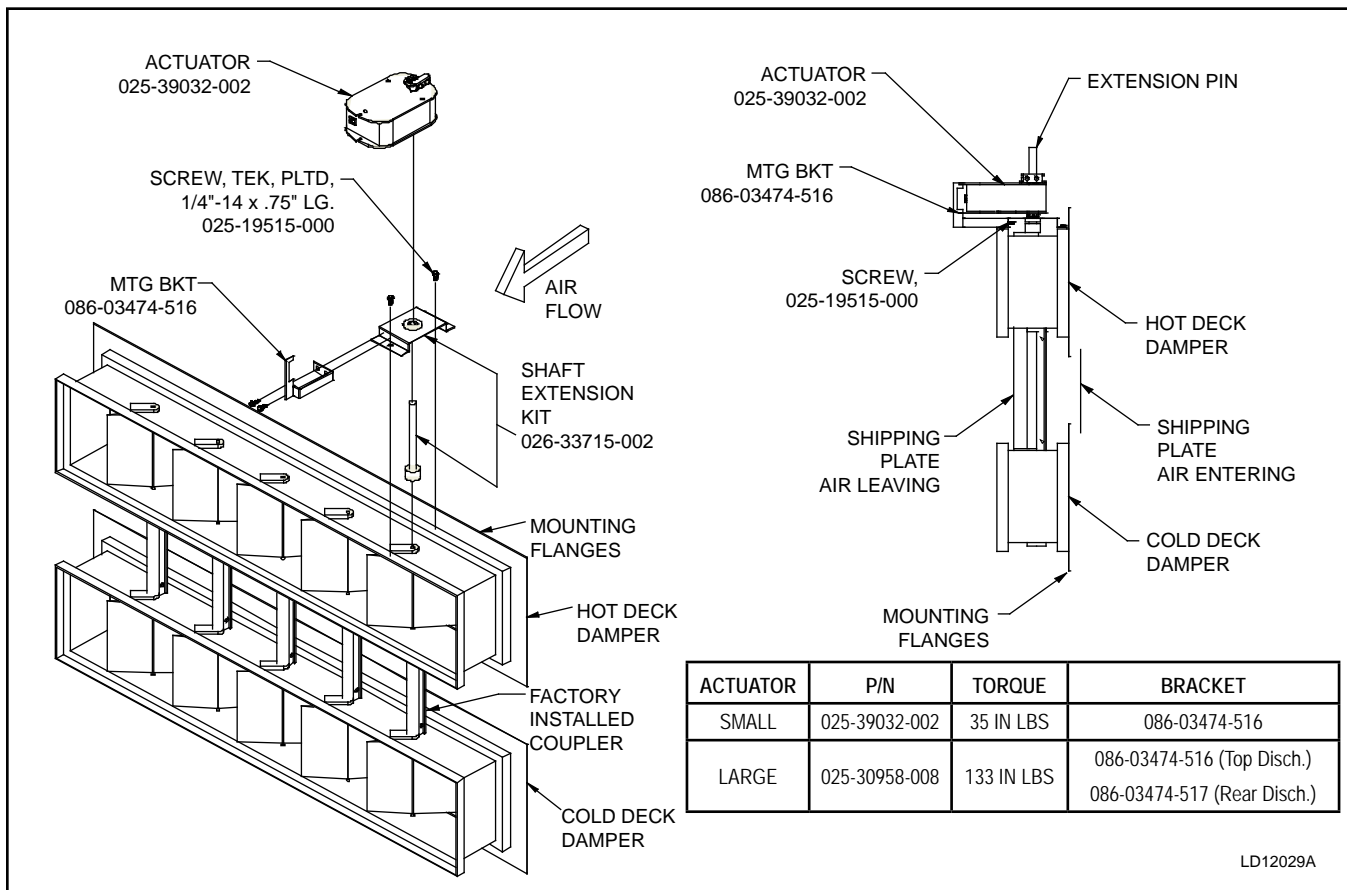
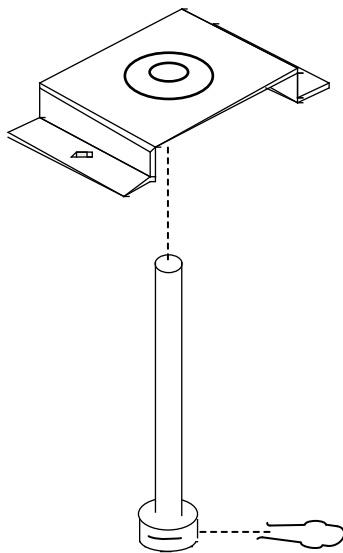


FIG. 2-36 – MZ DAMPER/ACTUATOR ASSEMBLY

ACTUATOR INSTALLATION MULTIZONE (MZ) - FIELD SUPPLIED

When actuators are field supplied on multizone dampers, the following information is intended to aid in sizing and selection:

- Torque required is 7 inch pounds per square foot of damper area up to 2500 FPM velocity.
- Damper blades are 6" wide and vary in height.
- Calculate the torque by number and size of blades in each individual zone. Remember there are hot deck blades directly connected to cold deck blades.
- Blades per zone are to be determined by system CFM and static pressure requirements for each zone by the Engineer's construction documents.
- The blade linkage (flat rods) connecting all blades of each deck are to be cut at the appropriate places to divide the decks into correct size zones. These blade linkage rods are mounted externally on the assembly. Be sure to cut a section of the flat connecting rod out. This is to prevent interference when zones modulate in opposite directions.
- One Damper Shaft Extension Kit is provided for each zone per the Factory Order Form (*see Fig. 2-37*).



DAMPER SHAFT EXTENSION KIT
P/N 026-33715-002

LD13784

FIG. 2-37 – DAMPER SHAFT EXTENSION KIT

- Actuators and actuator mounting brackets are to be supplied by the contractor. P/N's available upon request.
- On rear mount (discharge through end of unit); always mount the actuators on the top of the upper (hot) deck.
- Do not allow duct insulation to restrict damper blades or external linkage.
- Direct coupled actuators are recommended.
- Duct connections are to be made at the zone dividers without damper blade restriction.

INERTIA FAN BASE FILL INSTRUCTION

Inertia fan bases are pre-engineered according to fan & motor size. Each cavity having a pre-installed corrugated bottom is to be filled to the top with wet concrete. The contractor must take care not to get concrete mix on the bolts and adjusting parts of the adjustable motor base, sheaves, belts or on the floor under the edges of the isolated fan base. The amount of concrete can be calculated by measuring the overall length and width of the fan base assembly cavities that have the corrugated metal bottoms. The standard depth of the cavity is 4".

HUMIDIFIERS

Optional Steam humidifiers, when selected are provided with dispersion equipment factory mounted inside the air handling unit. The steam injection or generating equipment, metering devices & sundries are shipped loose with the unit. Humidifier manufacturer's installation, operation and maintenance information is packaged with the respective humidifier. It is the responsibility of the installing contractor(s) to make use of the instructions and preserve same for turn-over to the end user. All required steam supply piping, condensate piping & wiring are the responsibility of the installing contractor(s).

UVC EMITTER LIGHTS

When UV Lights are provided, the contractor is responsible for installing UV Lamps (tubes) and connecting a 120 volt power supply. The YORK Solution factory provides internal wiring with a magnetic door safety switch, a lockable disconnect switch with “Press to Test” pilot light and a latching circuit that has to be manually re-energized on the air handler exterior after a door has been opened and closed. This is all pre-wired. The UV Lamps (tubes) are shipped loose, but in protective packaging for installation by the contractor.



DO NOT touch UV Lamps (tubes) with bare hands or leather gloves as oils will damage the tubes. Use clean cotton rags, clean jersey or latex gloves to handle the lamps (tubes).

There three different types of lamps used in YORK Solution Air Handlers: V-Mod, V-Ray and V-Flex.

V-Mod lamps are installed in the same manner as standard fluorescent lamps with 2 contact prongs on each end. Engage the prongs into the slotted fixtures and rotate the lamp (tube) 90 degrees.

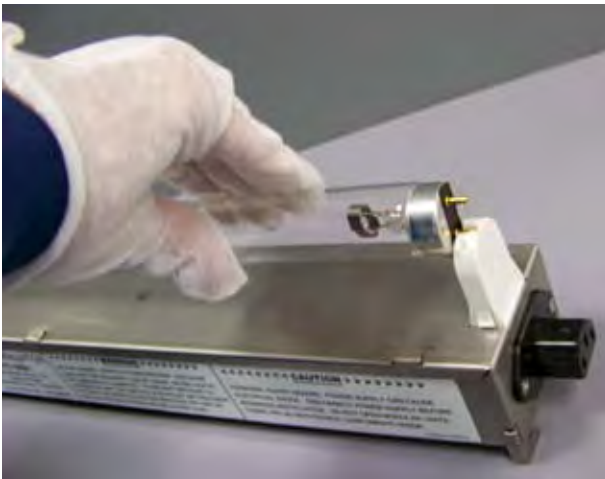


FIG. 2-38 – V-MOD INSTALLATION

V-Ray lamps (tubes) have all four contact prongs on one end of the lamp (tube). The lamp fits into clamps mounted in the air handler UV segment where a pre-wired pig tail is installed. Simply engage the plug on the pig tail with the prongs on the end of the lamp.



FIG. 2-39 – V-RAY INSTALLATION

V-Flex lamps (tubes) fit inside the opening at a slight angle (with the pins aligned with the lamp holder). You then “snap” the lamp base in by holding with slight pressure the end of the lamp you have placed inside the module with one hand and straightening up the other end of the lamp with your other hand until you hear the click.

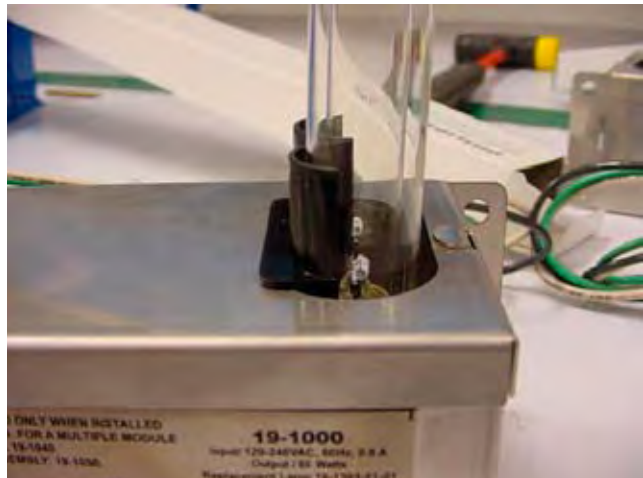


FIG. 2-40 – V-FLEX INSTALLATION

AIR MEASURING DEVICE CONNECTIONS (when provided)

AIR MEASURING AT THE FAN INLETS

COMETER is a probe attached to the fan bearing support on Comefri Forward Curve fans from size 7 x 7 up to 18 x 18. The probe is located on the outboard side of the DWDI fan assembly. The probe is piped to the negative (-) port of a factory mounted transducer on the fan wall. The positive (+) port is left open to the fan section. Wiring is not provided to the transducer unless factory packaged controls were selected.

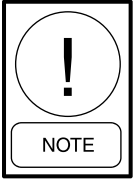
PIEZORING (PIEZOMETER) is a series of fittings in the inlet cone(s) of DWDI fans larger than 18 x 18 and all sizes of Plenum fans that are combined into a single connection piped to the negative (-) port of a factory mounted transducer on the fan wall. The positive (+) port is left open to the fan section. Wiring is not provided to the transducer unless factory packaged controls were selected.

AIR MEASURING AT UNIT INLETS

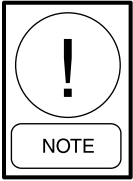
AMS-60 used on Indoor YORK Solution air handlers usually to measure outside air. This can be provided with one or two pairs of positive (+) and negative (-) connections. Connect (+) & (-) ports respectively to the (+) & (-) ports of the transducer(s). Wiring & transducer are not provided unless factory packaged controls were selected.

EAML used on Outdoor YORK Solution air handlers usually to measure outside air. This can be provided with one or two pairs of positive (+) and negative (-) connections. Connect (+) & (-) ports respectively to the (+) & (-) ports of the transducer(s). Wiring & transducer are not provided unless factory packaged controls were selected.

PIPE CHASE INSTALLATION



See “Ship Loose Parts” to identify gaskets and hardware items.



Pipe chase should be installed before piping is connected.

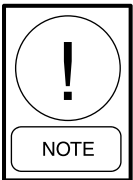
TOOLS REQUIRED

- Screw Gun
- Complete set of mechanics hand tools.

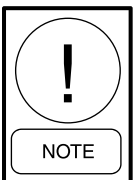
MATERIALS REQUIRED

- Shipped loose package containing 1/4"-14 x 1" Self-drilling Screws w/gasket, Caulking, 1/4" x 2" Neoprene Gasket.
- *When unit purchased with Baserail:* Pipe Chase Baserail Covers, 3/8"-16 x 1-1/2" Bolts and Lock Washers.

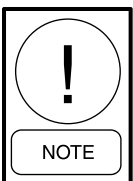
PROCEDURE



Never use silicone caulk/sealant or caulk/sealant containing silicone in or on any air handling equipment. [Only exception is when provided (high temperature) with gas heat venting]



The top and bottom flanges are inside pipe chase. Separate cover angles are used on external vertical seams.



Before installing pipe chase, remove any self-drilling screws from the top & bottom raceway and side panel that may interfere with the installation of the pipe chase or trim angles.

1. Preparation

- Pinpoint the exact location to attach the pipe chase.
- Ensure enough space will remain to apply pipe fittings with insulation, inside the pipe chase.
- The pipe chase height should align with the unit height.

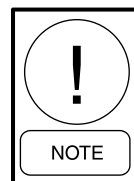
2. Apply Gaskets

- Apply provided 1/4" x 2" neoprene gasket to the underside of the air handler roof overhang (see Fig. 2-41).



FIG. 2-41 – INSTALL GASKET UNDER ROOF OVERHANG

- Apply gasket provided by curb vendor to top of curb.
- Apply 1/4" x 2" neoprene gasket to the pipe chase (vertical gaskets first, then horizontal gaskets). Keep the gasket aligned with the outside edges of the pipe chase housing (see Fig. 2-42).



Horizontal gaskets must completely overlap vertical gaskets in all four corners (see Fig. 2-42).

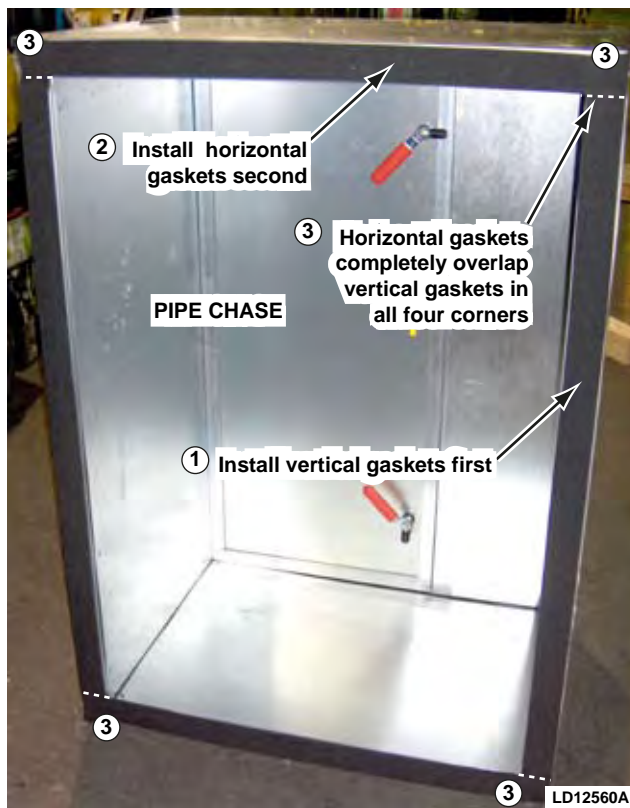


FIG. 2-42 – APPLY GASKET TO PIPE CHASE

3. Attach Pipe Chase

- Set the pipe chase on the pipe chase curb three inches away from the air handler.
- Tilt the top of the pipe chase toward the air handler. Work it under the air handler roof overhang, being careful not to damage the neoprene gaskets. Lift the pipe chase slightly to clear the gasket on the curb and swing the bottom against the air handler.
- If there is a baserail, attach the baserail of the pipe chase to the baserail of the air handler. Use 3/8" bolts & lock washers provided; placing bolts through the pipe chase baserail brackets into the threaded holes in the air handler baserail (see Fig. 2-43).
- Make sure the pipe chase is square and the door(s) close and open without rubbing or binding.
- Secure the pipe chase to the top and bottom raceways (heavy gage metal) of the air handler through the pre-punched holes of the inside top and bottom flanges of the pipe chase. Use 1/4"-14 x 1" hex head self-drilling screws (see Fig. 2-44).

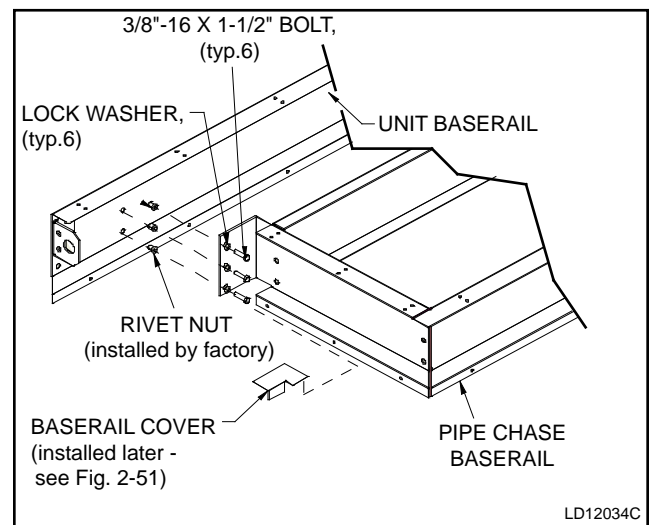


FIG. 2-43 – PIPE CHASE BASERAIL TO UNIT BASERAIL INSTALLATION (When Purchased)

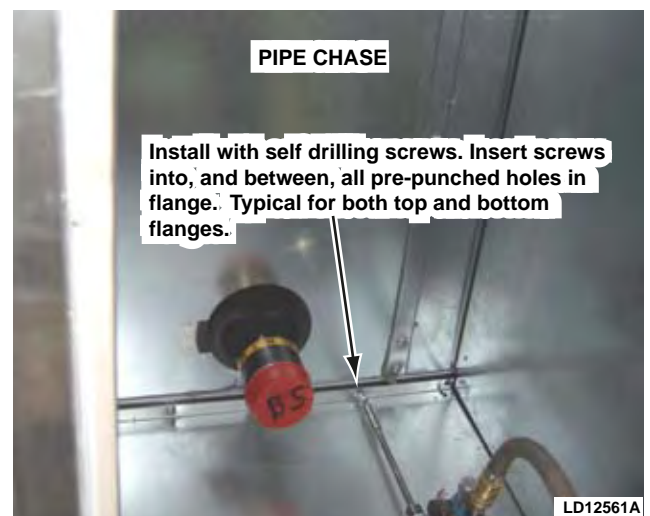
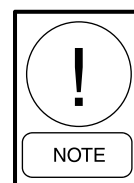


FIG. 2-44 – SCREW PIPE CHASE TOP AND BOTTOM INTERNAL FLANGES TO AIR HANDLER



Do not over tighten or strip self-drilling screws. Screws in top and bottom flanges go into heavier gauge metal than screws in cover angles.

- Check to be sure door closes and latches properly. If not, loosen self-drilling screws, re-align pipe chase and re-tighten screws. Occasionally the curb under the pipe chase may be uneven, depending on installation.
- ### 4. Seal Pipe Chase to Air Handler.
- Apply caulking to all exterior joints between pipe chase and air handler baserails (when purchased) (see Fig. 2-45).

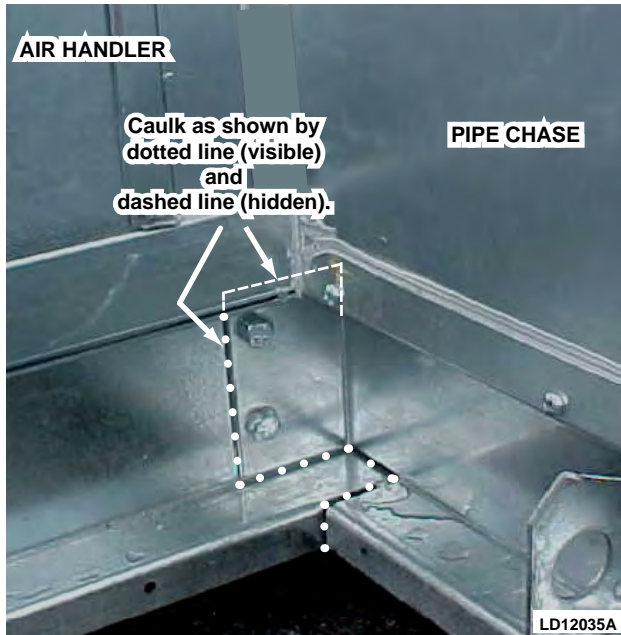


FIG. 2-45 – BASERAIL CAULK APPLICATION

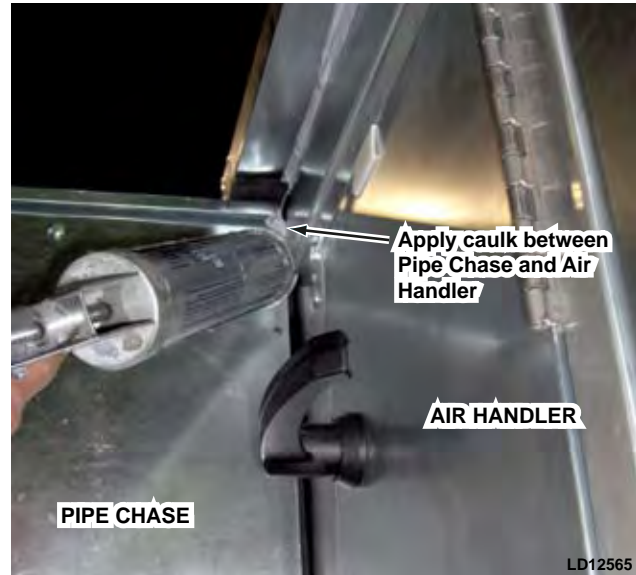


FIG. 2-47 – PIPE CHASE TO AIR HANDLER CAULK APPLICATION

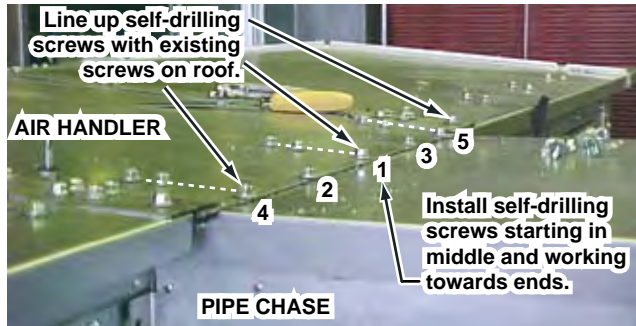
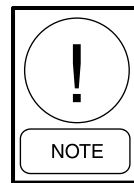


FIG. 2-46 – PIPE CHASE TO ROOF INSTALLATION

- Add a small bead of caulking to the exterior vertical seam between the air handler and the pipe chase to insure complete seal. Pay special attention to the top & bottom corners, raceway & baserail engagements and under the roof overhang (see Fig.'s 2-45 & 2-47).
- Starting at the center, and working toward each end, run 1/4"-14 x 1" hex head self-drilling screws down through the air handler overhang into the top of the pipe chase through the gasket. Use caution not to strip the 20-gage housing with the screws. Line up self-drilling screws with double row of screws on top of unit raceway, plus one spaced evenly between each (see Fig. 2-46) (No caulking required here.)

5. Install the Cover Angles

(See Fig. 2-48)



Cover angles must be installed before the caulk from step 4 dries.

- Apply 1/4" x 2" neoprene gasket to contact side of cover angle.
- Remove top and bottom self-drilling screws from pipe chase and set aside for later use.
- Place cover angles in vertical corners of pipe chase and unit wall.

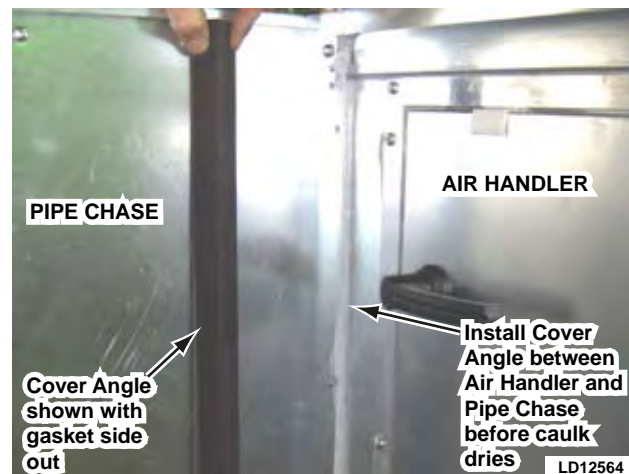
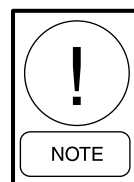


FIG. 2-48 – INSTALL COVER ANGLE



Notch on cover angle must be on the air handler side (see Fig. 2-48).

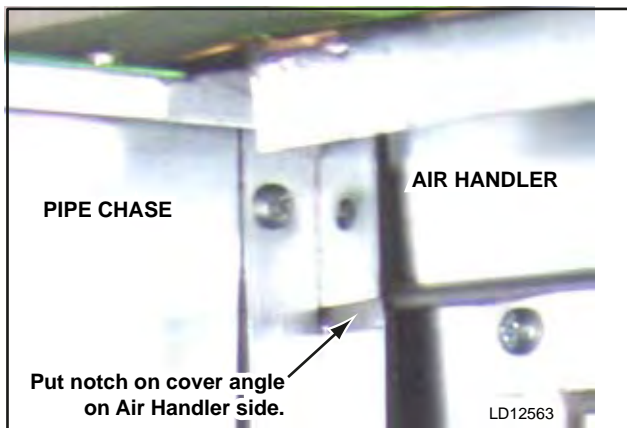
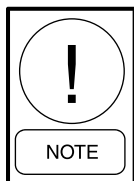


FIG. 2-49 – PROPER POSITIONING OF COVER ANGLE WITH NOTCH ON AIR HANDLER SIDE

- Attach the cover angle to the air handler and pipe chase panels. Install self drilling screws removed earlier to top and bottom holes on cover angle.
- Starting at the top and alternating between the air handler and pipe chase, continue installing self drilling screws until reaching the bottom. Use caution not to strip the housing (see Fig.2-50).

6. Install the Pipe Chase Baserail Covers
(See Fig. 2-51)

- On the perimeter of the cover, caulk the underside as shown.
- Apply cover to exposed baserail seam between pipe chase and air handler (both sides) (no screws required).



All pipe chase floor penetrations must be flashed, sealed and insulated to prevent condensation entering building.

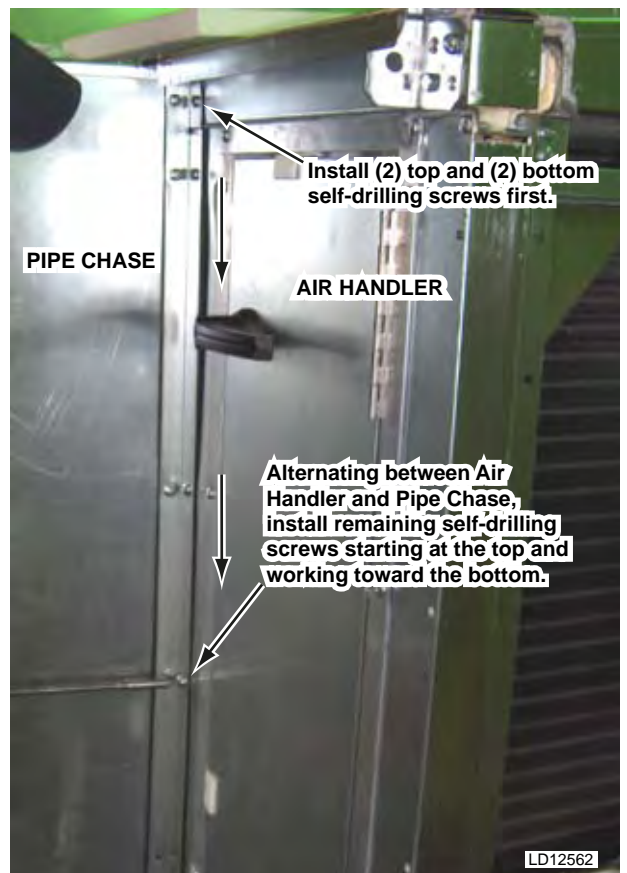


FIG. 2-50 – PROPER PATTERN FOR INSTALLING SELF-DRILLING SCREWS TO COVER ANGLE

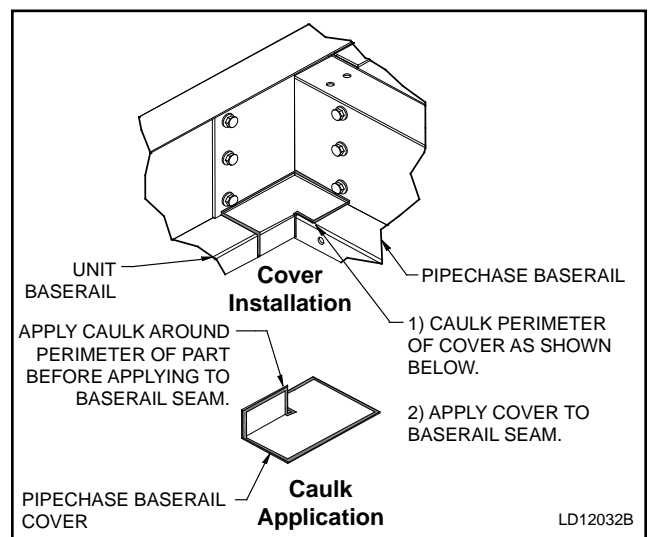
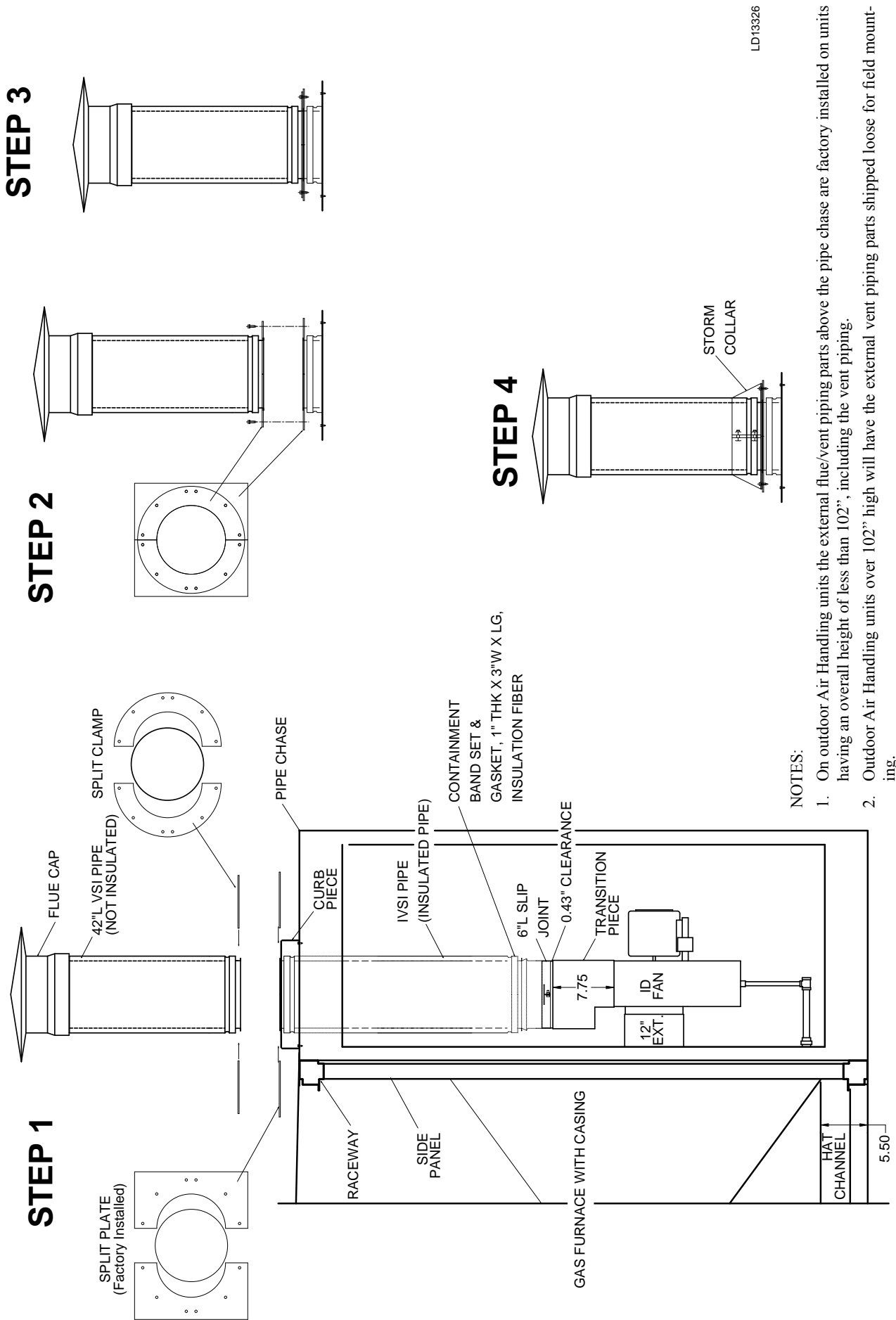


FIG. 2-51 – BASERAIL COVER APPLICATION



- NOTES:
1. On outdoor Air Handling units the external flue/vent piping parts above the pipe chase are factory installed on units having an overall height of less than 102", including the vent piping.
 2. Outdoor Air Handling units over 102" high will have the external vent piping parts shipped loose for field mounting.
 3. On all outdoor Air Handling units the vent piping parts internal to the pipe chase will be factory mounted.

FIG. 2-52 – GAS FURNACE FUEL VENTING SYSTEM

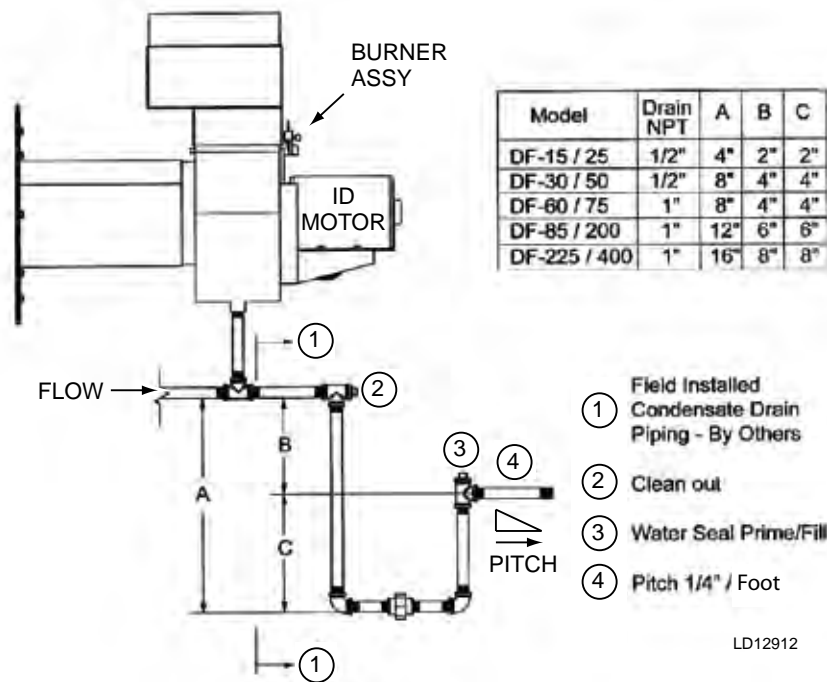
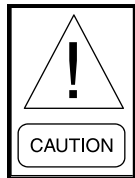


FIG. 2-53 – GAS FURNACE CONDENSATE DRAIN TRAP

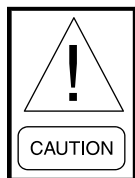
CONDENSATE DRAIN ARRANGEMENT

The YORK Solution Indirect Fired gas heat exchanger has the potential to create highly acidic condensation, particularly during extended operation at low capacity or low firing rate conditions. To insure proper drainage the following guidelines should be followed (See Fig. 2-53).



When constructing the condensate trap for the heat exchanger drainage system, make sure the trap is tall enough to handle the Total Static Pressure of the ID Blower at Low Fire times 2.

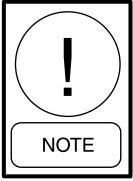
Example: TSP is 6" at Low Fire - construct trap 12" tall (See Table in Fig. 2-53).



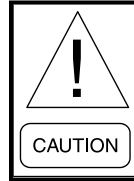
Failure to follow these guidelines may cause excessive condensation build up resulting in water damage to the facility and/or a cracked heat exchanger.

1. Observe local jurisdiction codes for gravity condensate drainage requirements.
2. Be sure the air handler is installed at an elevation that enables proper condensate drainage and trapping dimensions as provided in Fig.2-53. Minimum trap dimensions MUST be accommodated.

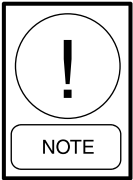
3. Condensate drain line size must be the full line size of the heat exchanger drain connection.
4. Drain lines, fittings and supports should conform to local codes and be suitable for the application.
5. Condensate drain and trap discharge should be pitched away from the equipment at a slope of 1/4" per linear foot or as local code dictates.
6. For outdoor or unconditioned space installations local climate may dictate the need to heat trace and/or insulate the exposed drain lines and trap. Frozen drain lines and/or trap will cause build up of condensate inside the heat exchanger resulting in leakage and damage to the air handler and possibly to the facility.
7. Provide unions in drain lines to allow removal of trap for periodic cleaning of drain lines as well as the trap. When the burner is operated at low capacity for extended periods, more condensate is generated and with it deposits of solids in the condensate drainage system.
8. Provide the ability to prime the trap. During initial and seasonal start up, trap inspection and priming is required. Condensate in the trap will evaporate during long periods of non-use.

ELECTRICAL - GENERAL

All field wiring must conform to the National Electrical Code (N.E.C.) and possible local codes that may be in addition to N.E.C.



DO NOT PENETRATE any main or auxiliary drain pan.
DO NOT PENETRATE roof of outdoor unit.



Unit is E.T.L. Listed. Some components are U.L. labeled. Any changes in the field may affect their validity.



DO NOT PENETRATE WIREWAYS in any manner. These sheet metal channels, which run along the top panel, contain electrical wires and connections. **Electrical shock and/or damage to the unit may result.**

The current characteristics, phase, cycle and voltage are stamped on the nameplate of each component.

Electrical conduit connections made to exposed boxes on units should be made on the bottom of the box. Installation should comply with code requirements. Outdoor installation must be made watertight.

The installing contractor is responsible for electrical conduit penetrations through the building roof.

Penetrations through panels must be sealed (*see IOM Section 5 "Penetrations and Grommet Details"*). ►



Electrical conduits that penetrate the exterior (walls, pipe chase or floors) of the unit will need to be externally and internally sealed so that unconditioned air will not be drawn into the unit through and around conduit. This unconditioned air will result in condensation that will fail components prematurely.



All accessible electrical connections must be checked for tightness prior to the actual startup. Many of the connections contain several strands of wire, and while they were tightened at the time of assembly, they should be checked and re-tightened if needed. The danger of a poor connection is overheating and component failure.

Electrical drawings are provided in the information packet on the inside of a unit access door. Major optional components will have specific electrical and IOM information packed inside their control panels or attached. *See IOM Section 6 for generic electrical drawings.*

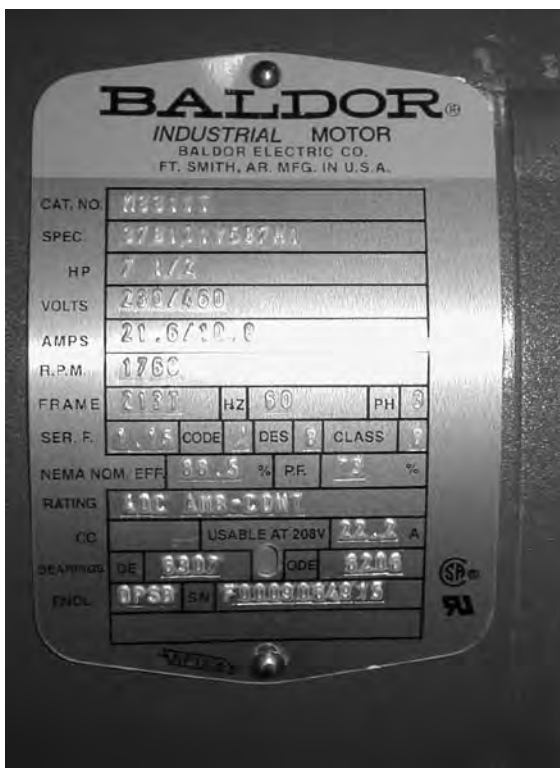
POWER CONNECTIONS

SINGLE POINT POWER

Single Point Power when ordered provides the installer with a main disconnect switch. The line side of this switch (top) is where the installer is to land his main power wires. Devices included in the Single Point Power option are Supply Fan, Return Fan, Exhaust Fan, Energy Recovery Wheel, Gas Heat, Electric Heat and Ultra-violet Lights. Special Quoted devices may be purchased with the air handler that are NOT included in the Single Point Power option. These items will require separate, additional power wiring by the installer. When Single Point Power is NOT purchased the installer is responsible for wiring to each electrical component.

MOTORS FOR SUPPLY FAN, RETURN FAN, EXHAUST FAN

A motor connection diagram may be found on the inside of the motor terminal box or on a tag attached to the motor. Be sure to make a flexible conduit connection at the motor to permit fan belt adjustment and movement of spring isolated fan assembly. Refer to Motor Data Nameplate for all motor specifications (see Fig. 2-54).



00495VIP

FIG. 2-54 – TYPICAL MOTOR DATA / NAMEPLATE

ENERGY RECOVERY WHEEL OPTION

Wiring of this device is the responsibility of the installer if Single Point Power was not selected. Use of the attached plug and/or pigtail is optional. YORK does not provide pre-wired mating cables.

On wheels of 52" diameter and smaller the motor comes with a cord. Single Phase motors have a 3-pin standard AMP connector on the cord. Three Phase and VFD models have a 4-pin standard AMP connector on the cord.

On wheels of 54" diameter and larger the motor does not come with a cord.



LD11591

FIG. 2-55 – TYPICAL POWER WIRING OF ENERGY RECOVERY WHEEL

GAS HEAT OPTION

Wiring of this device is the responsibility of the installer if Single Point Power was not selected.

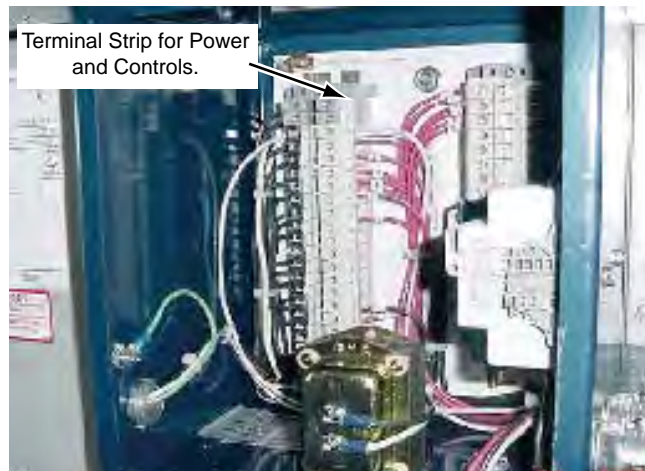
Panel locations and sizes vary based upon unit size and burner configurations.

Burner voltage is selected to match primary unit voltage.

Modulation control voltage to be 2-10 VDC as standard.

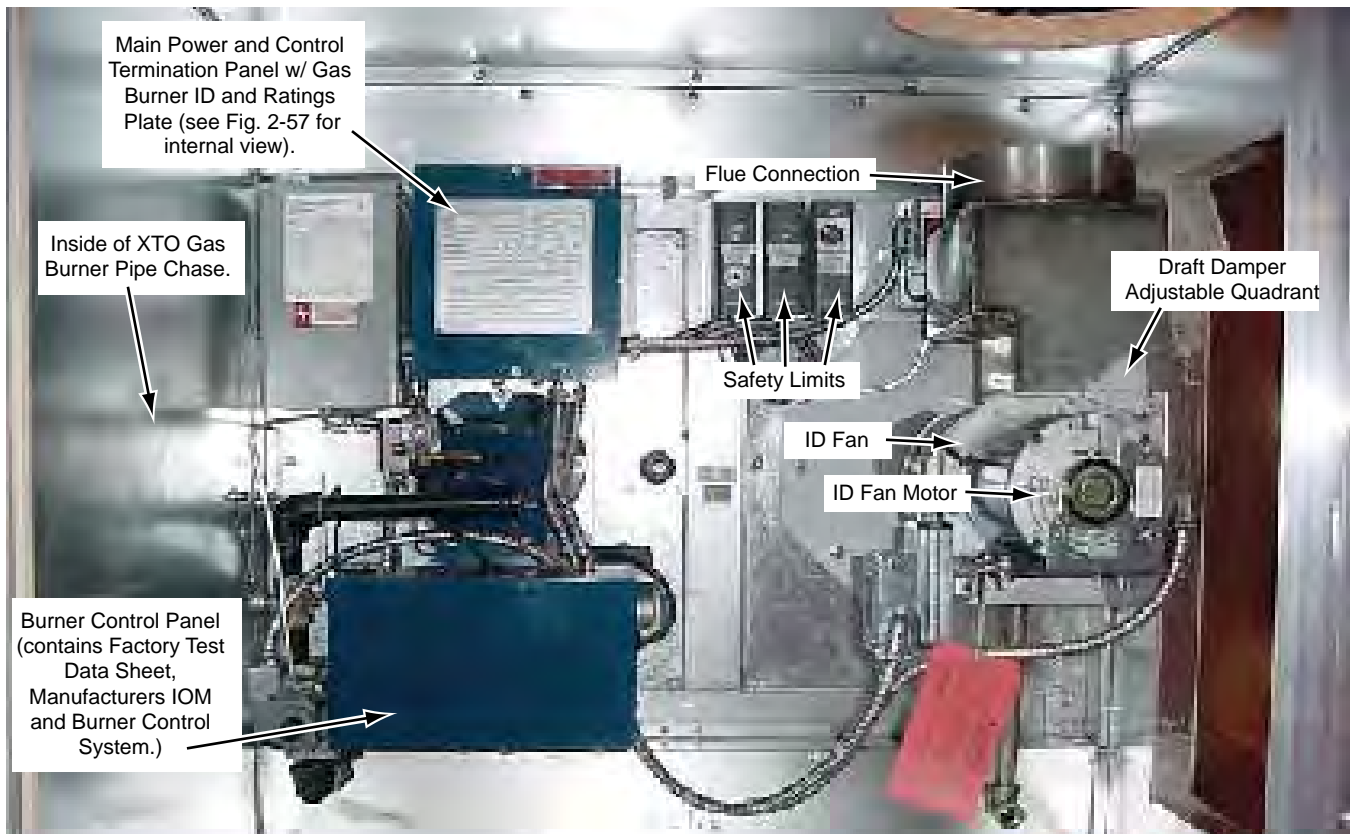
Electrical penetrations can come through the floor or side wall panels. Any penetration will have to be drilled and must be properly sealed to keep out moisture. Refer to IOM Section 5 “Field Penetrations for Piping & Electrical Connections”. ▶

Make power connections per wiring diagrams, provided inside burner control panel. Also see generic diagrams in IOM Section 6. Refer to Fig. 2-56 and Fig. 2-57 for Gas Burner component locations.



LD11597

FIG. 2-57 – MAIN POWER AND CONTROL PANEL W/ COVER OPEN



LD11596B

FIG. 2-56 – GAS BURNER COMPONENT LOCATIONS

ELECTRIC HEAT OPTION

Wiring of this device is the responsibility of the installer if Single Point Power was not selected.

AVAILABLE POWER OPTIONS

- 460V-3PH.
- 208/230V-3PH.
- 380V-3PH.
- 575V-3PH.

ELECTRIC HEAT DISCONNECT SWITCH OPTIONS

- Fused Disconnect.
- Non-fused Disconnect.

Knockouts are provided on the top and bottom of the enclosure for field penetrations. The YORK Solution foam panel will have to be drilled to utilize these knockout locations. Refer to IOM Section 5 “Field Penetrations for Piping & Electrical Connections”.

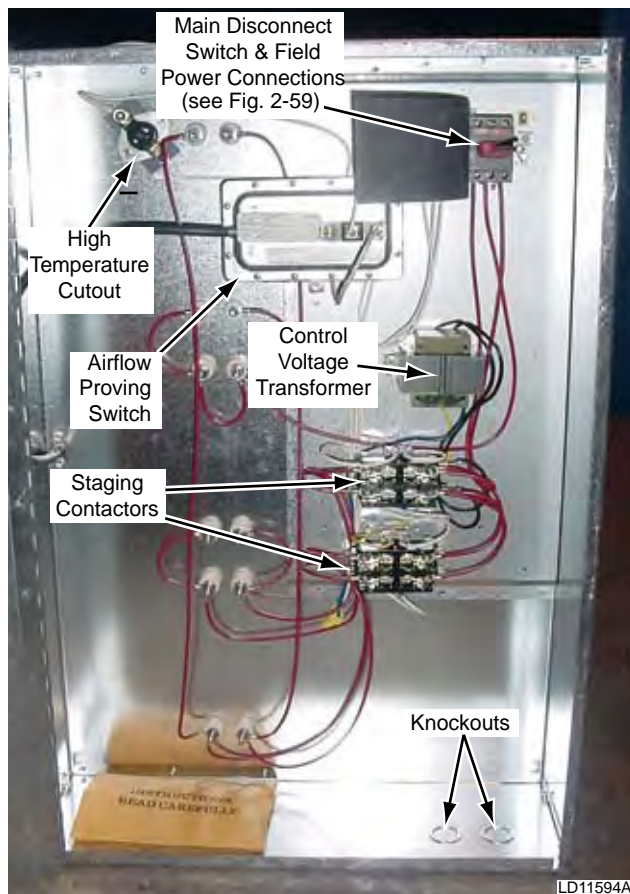


FIG. 2-58 – TYPICAL ELECTRIC HEAT CONTROL PANEL INTERIOR WIRING AND COMPONENTS

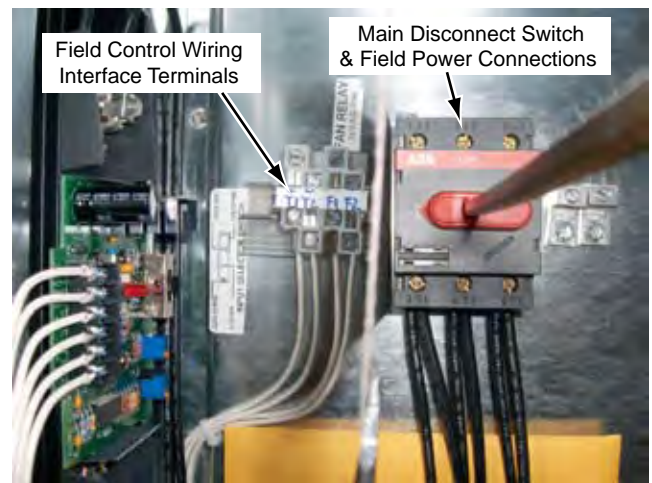
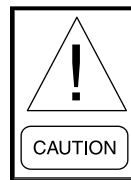


FIG. 2-59 – TYPICAL FIELD CONTROL AND POWER CONNECTIONS

Hook up power (see Fig. 2-59 for power terminals and Fig. 2-58 for control panel component location). Terminals shown are for a 2 stage 24 VAC control interface. Terminals may also require 120VAC control interface based upon options selected. See wiring diagram on inside cover of electric heat control panel.



Electrical conduits that penetrate the exterior (walls, pipe chase or floors) of the unit will need to be externally and internally sealed so that unconditioned air will not be drawn into the unit through and around conduit. This unconditioned air will result in condensation that will fail components prematurely.

All accessible electrical connections must be checked for tightness prior to the actual startup. Many of the connections contain several strands of wire, and while they were tightened at the time of assembly, they should be checked and re-tightened if needed. The danger of a poor connection is overheating and component failure.

DO NOT PENETRATE any main or auxiliary drain pan.

AVAILABLE CONTROL OPTIONS

- Staging - No controller, but contactors are energized by providing control power to each contactor from external BMS source.
- Step Controller - device to receive a 0- to 10 VDC or 4 to 20 mA signal and step on heat stages. Mechanical/electrical device.
- Vernier SCR - completely electronically controlled by varying signal and varying output between stages. Increases power to a stage by modulation until another stage is needed. Energizes another stage and modulates power until another stage is needed. 0 to 10 VDC or 4 TO 20 mA. Less expensive than Full SCR. This system utilizes a step controller and one SCR that modulates and resets for each stage.
- Full SCR - completely electronically controlled by varying signal and varying output of a controller. Like a VFD for electric heat. 0 to 10 VDC or 4 to 20 mA. The controller modulates a separate SCR for each stage.

INSTALLATION



Rotating parts and electrical shock hazards exist. Lock out and tag out the fan motor(s) and heat power disconnects before servicing. FOLLOW THE LATEST "LOCKOUT TAGOUT" PROCEDURE. Failure to follow proper safety precautions may result in serious injury or death

APPLICATION INFORMATION

1. Follow the procedure given in this instruction to find the minimum air velocity for safe operation (see Fig. 3-25). At least this minimum velocity must be provided at all points over the heater face area. Failure to meet this requirement may result in serious damage or nuisance thermal cutout tripping.

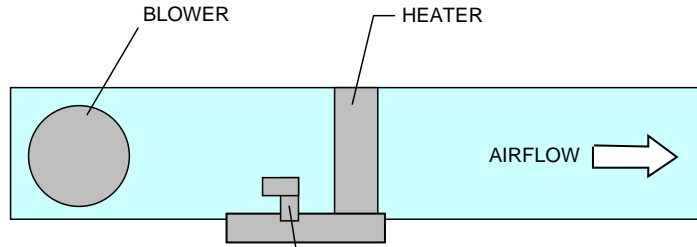
2. The maximum air inlet temperature for open coil heaters is 100° F, and for finned tubular heaters, 80° F.
3. Sufficient working space must be provided per paragraph 110-26 of the NEC.
4. This electric heater is not designed for or intended to be used for temporary heat prior to system startup / balancing.

MECHANICAL INSTALLATION

1. All heaters will contain an adjustable airflow switch in the heater control panel. This switch will be preset to close at a differential pressure of approximately 0.3" W.C. In all cases the switch will be connected to a pressure probe positioned in the airstream. This probe has an arrow stamped on it that is viewable from inside of the control panel. When the heater is located upstream of the fan this arrow will point away from the fan. When the heater is located on the downstream side of the fan the arrow will again point away from the fan or with airflow. If it is incorrectly installed, remove the (2) screws holding the pressure probe in place and rotate 180° and reinstall. The airflow switch pressure port that is not connected to this pressure probe will be run to the exterior of the air handling unit to source a reference differential pressure. In some situations it may be necessary to adjust this airflow switch setting to allow for proper operation. Precautions must be made at this time to make sure that the airflow switch does not provide a false indication of airflow. Failure to meet this requirement may result in serious damage or nuisance thermal cutout tripping (see Fig. 2-60 and 2-61).
2. A visual inspection of the heater elements should be made prior to use of the heater. If physical damage is evident, a Megohm test should be used to validate the heater elements are safe for use. If a minimum value of 10 megohms is not achieved then any damaged elements or ceramic insulators must be replaced prior to operation.

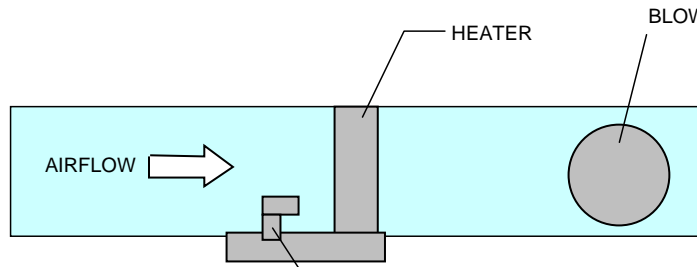
TOP VIEW OF UNIT

POSITIVE PRESSURE / AIR BLOWN THROUGH HEATER



PICK UP TUBE TOWARDS BLOWER
ATTACHED TO "HIGH" PORT OF AIRFLOW SWITCH

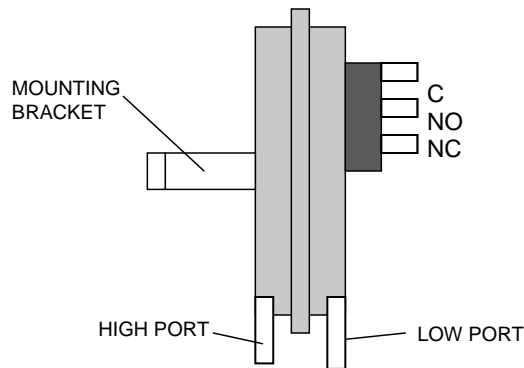
NEGATIVE PRESSURE / AIR DRAWN THROUGH HEATER



PICK UP TUBE TOWARDS BLOWER
ATTACHED TO "LOW" PORT OF AIRFLOW SWITCH

LD14268

FIG. 2-60 – PRESSURE PROBE DIRECTION



LD14270

FIG. 2-61 – AIRFLOW SWITCH CONNECTIONS

ELECTRICAL INSTALLATION

1. Follow the wiring diagram on the inside of the terminal box.
2. Supply connections must be made with copper wiring rated for 75° C minimum.
3. If supply connections are for 250 volts or greater, all wiring must be insulated for 600 volts.
4. When making line connections to heater element terminals FOR FINNED TUBULAR HEATERS ONLY, apply a 1/4" wrench to flat section of terminal immediately below threads. Otherwise damage to terminal may result.
5. Supply conductors for heaters rated less than 50 KW, must be sized at 125% of rated load. On heaters rated 50 KW and more, the supply conductors may be sized at 100% of rated load, if indicated on the wiring diagram. The line current for either a single or three phase load is calculated as follows:

$$\text{Single Phase Line Current} = \frac{\text{KW} \times 1000}{\text{Voltage}}$$

$$\text{Three Phase Line Current} = \frac{\text{KW} \times 1000}{\text{Voltage} \times 1.73}$$

6. The following table shows the maximum current for 75 °C copper wire with not more than 3 conductors in a raceway. It is based on the National Electrical Code Table 310-16. The amperages shown are for 125% and 100% wire sizing. If there are more than 3 conductors in a raceway, derate these amperages per Table 310-15(b)(2)(a).

| AMPS | | WIRE SIZE AWG/ MCM | AMPS | | WIRE SIZE AWG/ MCM | AMPS | | WIRE SIZE AWG/ MCM |
|------|------|--------------------------|------|------|--------------------------|------|------|--------------------------|
| 125% | 100% | | 125% | 100% | | 125% | 100% | |
| 12 | | 14 | 80 | 100 | 3 | 184 | 230 | 4/0 |
| 16 | | 12 | 92 | 115 | 2 | 204 | 255 | 250 |
| 24 | | 10 | 104 | 130 | 1 | 228 | 285 | 300 |
| 40 | | 8 | 120 | 150 | 0 | 248 | 310 | 350 |
| 52 | 65 | 6 | 140 | 175 | 2/0 | 268 | 335 | 400 |
| 68 | 85 | 4 | 160 | 200 | 3/0 | 304 | 380 | 500 |

7. When connecting heaters with more than one stage, wire stage No. 1 so that it is the first stage on and the last stage off.
8. The heater must be wired so that it cannot operate unless air is flowing over it. This can be accomplished by using a built-in airflow switch and a remote interlock. *See the accompanying wiring diagram for the method used with this heater and provide appropriate interlock wiring as illustrated.* This diagram will be located inside of the electric heater control panel.
9. If not supplied as part of this heater, install a line disconnect switch or main circuit breaker in accordance with the National Electrical Code. Depending upon the heater's location and accessibility, a built-in disconnect switch may meet this requirement.
10. All electrical connections in the heater, including both field and factory made connections, should be checked for tightness before operating the heater. In addition, after a short period of operation, all connections should again be checked for tightness.
11. If heater is wired to a heating / cooling thermostat, use a thermostat with isolating circuits to prevent possible interconnection of Class 2 outputs.
12. If the heating elements are divided into several sections with resistance wire between two or more sections, maximum KW per sq. ft. should be calculated as follows:

$$\frac{\text{Heater nameplate KW}}{\text{Number of heated sections} \times \text{area of one heated section}}$$

HUMIDIFIER OPTION (ELECTRIC)

Wiring this device is the responsibility of the installer. This device is not included in any Single Point Power options. Fig. 2-62 represents a typical electric humidifier panel layout. The supply power knockout is located in the bottom of the electrical panel as seen in Fig. 2-63. All conduit beginning or ending inside pressurized or conditioned areas (i.e. air handler) must have all openings of conduit sealed to prevent air from passing through. All air handling unit penetrations must be sealed to prevent air and water leakage (*see IOM Section 5 "Penetrations and Grommet Details"*).

► Field provided disconnects must provide circuit protection according to the humidifier nameplate. All field wiring to the humidifier must be in accordance with NEC and local codes and by laws.



↑
↑
↑
KNOCKOUTS

LD11727

2

FIG. 2-63 – SUPPLY POWER KNOCKOUTS



LD11726

FIG. 2-62 – TYPICAL HUMIDIFIER PANEL LAYOUT

HUMIDIFIER OPTION

Control wiring diagrams are located in the humidifier manufacturer's IOM found inside control panel or attached. Factory package control drawings may not include humidifier points.

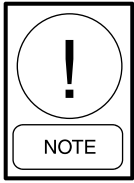
If humidifier IOM cannot be located inside humidifier, call Airside Product Support for information on electronic version.



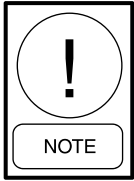
LD11725

FIG. 2-64 – HUMIDIFIER POINTS

PIPING CONNECTIONS

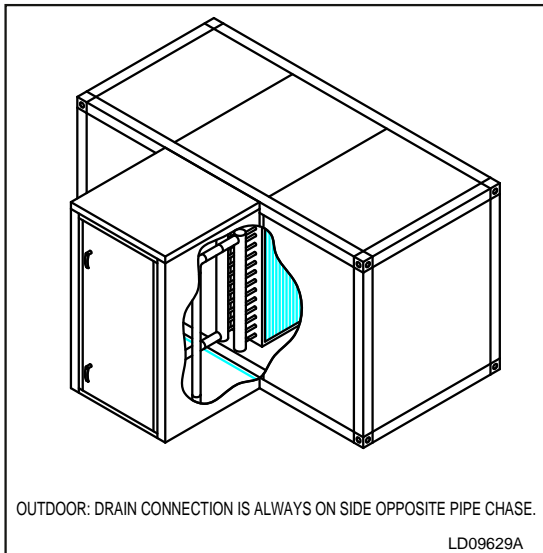


Do not remove bottom panel in pipe chase.



When extended piping to or from coils, humidifiers, etc., is present inside the air handler, field provided and installed insulation is required.

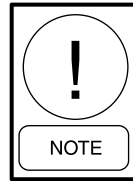
- Whenever possible, piping should be brought down through outdoor units within the pipe chase (see Fig. 2-65).



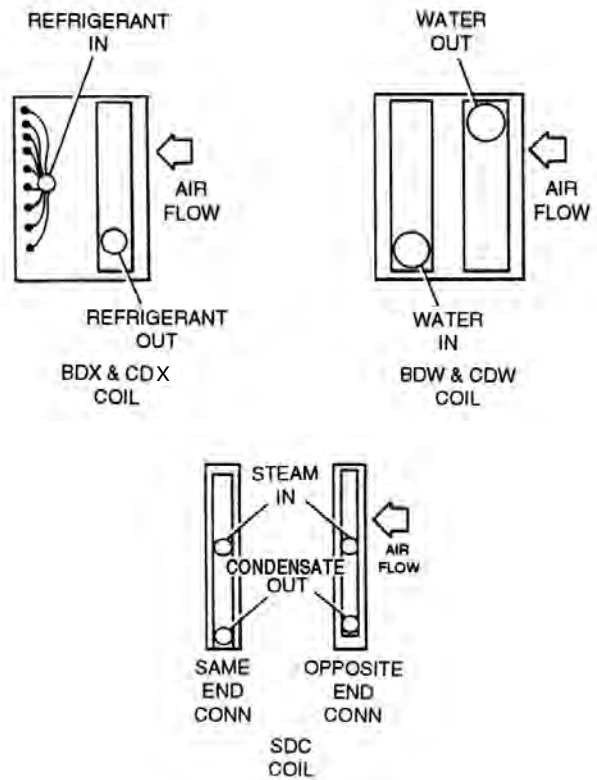
Usable working clearance is approximately the depth of the pipe chase minus 5".
All dimensions are approximate and not certified for construction.

FIG. 2-65 – PIPE CHASE ENCLOSURE

- Penetrations through pipe chase floor must be flashed and sealed.
- Penetrations through panels must be sealed (see IOM Section 5 “Penetrations and Grommet Details”). ▶
- Where piping is insulated, insulation should not be installed until after the flashing has been completed.



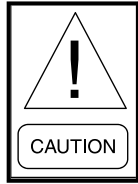
Pipe chase should be installed before piping is connected.



LD06340-1

FIG. 2-66 – FACTORY COIL CONNECTIONS

COIL PIPING



Do not test, clean and flush piping through this equipment.

Isolate this equipment from pressure testing of water, steam gas and air piping.

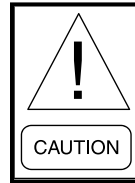
Consult the job specifications and submittal drawings for specific piping requirements, coil connection sizes and location. The unit should be level to assure proper venting and draining of coils. The piping arrangements must provide for a balanced flow in multiple coil installations (*see Fig. 2-66 showing factory coil connections*).

Support all connecting piping independently of the coils. Provide swing joints or flexible fittings in all piping connections, particularly adjacent to heating coils, to absorb expansion and contraction strains. Rigid piping connections can cause coil damage.

The coil supply and the return pipe connections are labeled. When attaching piping to the coil header, make the connection only tight enough to prevent leaks. Excessive tightening may cause damage to the header. A backup wrench should be firmly held on the coil connection so that in tightening the connecting

piping the torque is not transmitted to the coil header, thus damaging the coil connection.

Application Notes - All connections are male piping thread except DX coils, which are solder. Drain and vent taps on water coils are pipe thread shipped with plugs installed. These taps are installed approximately two inches back from the end of the threaded connections.

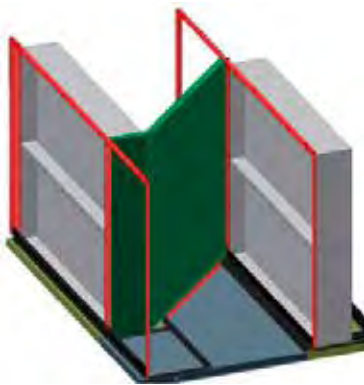


Pipe for balanced flow and assure even airflow.

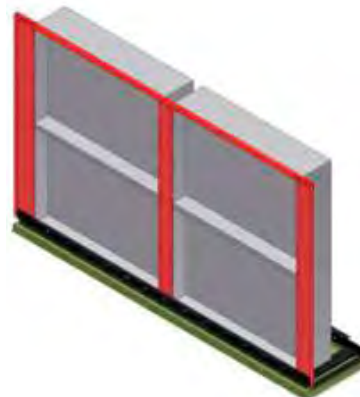
STAGGERED COILS

Staggered Coils in Expanded Cabinet size units will have connections brought to the unit exterior for liquid or steam coils. DX coils not included.

- The external connections are either threaded pipe or grooved pipe for the contractor to make his connections when the media is liquid.
- The external connections are threaded pipe for the contractor to make his connections when the media is steam.
- The installing contractor is responsible for insulating piping extensions we provided inside the air handler.



STAGGERED COIL – ANGLE WALL



STAGGERED COIL – OPPOSITE SIDE CONNECTIONS

FIG. 2-67 – STAGGERED COIL CONFIGURATIONS

WATER

WATER COILS - HOT WATER & CHILLED WATER

Connect the water supply to the header connection on the leaving air side of the coil to achieve the counter flow of water and air. The return pipe will be connected to the remaining coil connection.

Install an air vent in place of the top pipe plug on the return header. In order to provide for drainage, install a drain line and shutoff valve in the supply near the coil or in place of the plug in the supply connection. See Figs 2-68, 2-69 & 2-70 for typical piping diagrams.

HOT AND CHILLED WATER COIL PERFORMANCE

The temperature rise of the air (hot water coil) or temperature fall of the air (chilled water coil) leaving the coil is dependent on the airflow across the coil, the gallons of water flow through the coil and the entering water temperature into the coil. Consult the submittal for each job for the specific information.

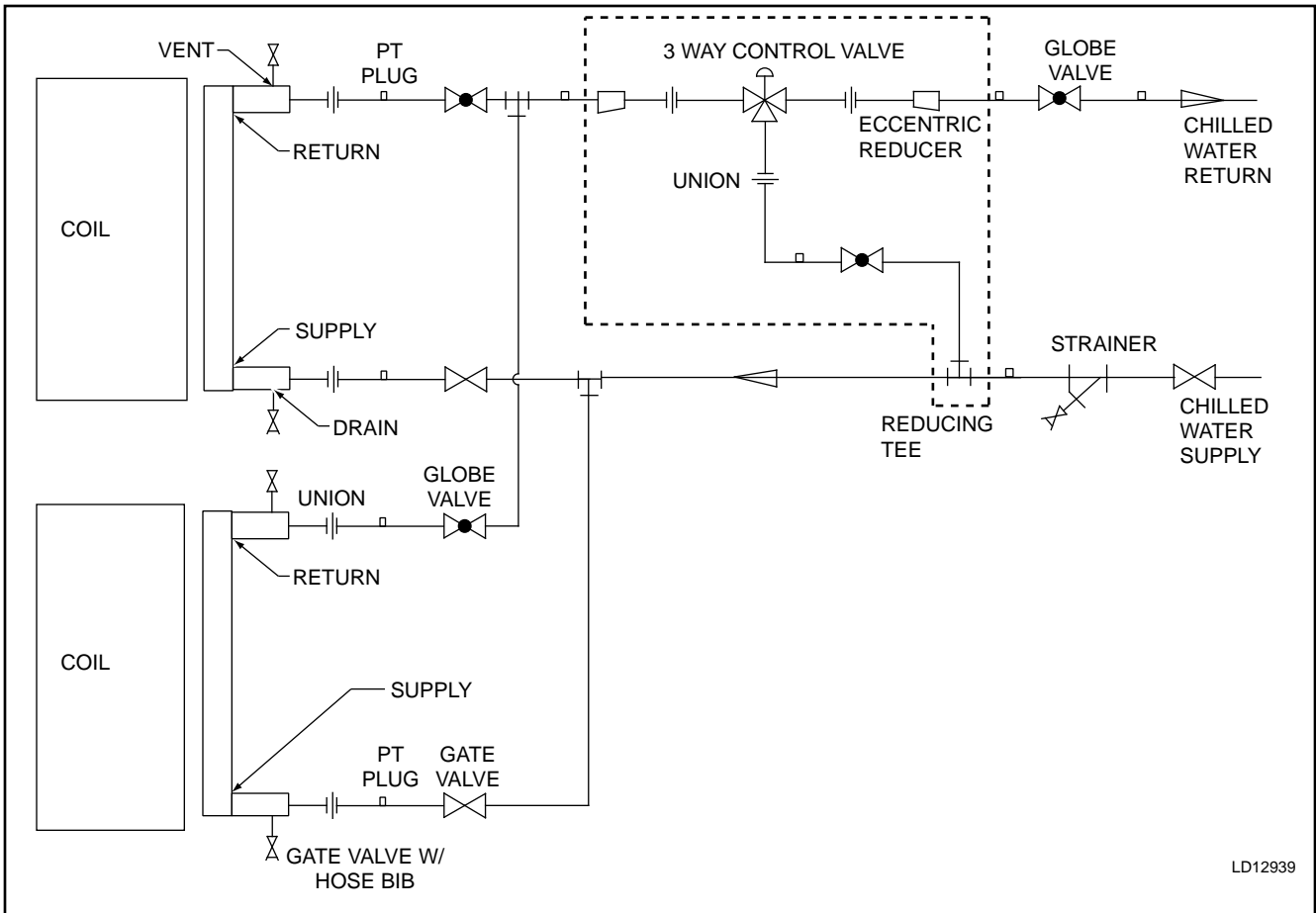


FIG. 2-68 – CHILLED WATER COIL CONNECTIONS Example - NOT for construction

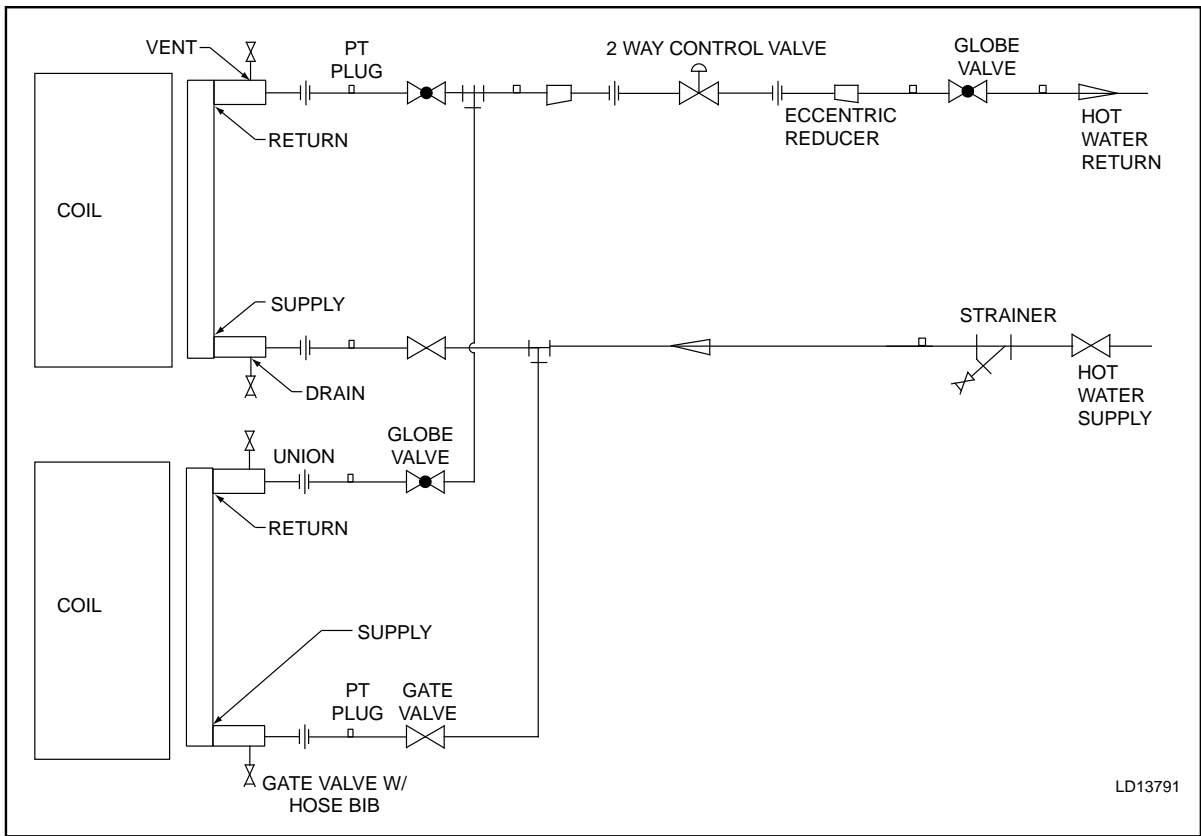


FIG. 2-69 – HOT WATER PIPING - 2 WAY VALVE Example - NOT for construction

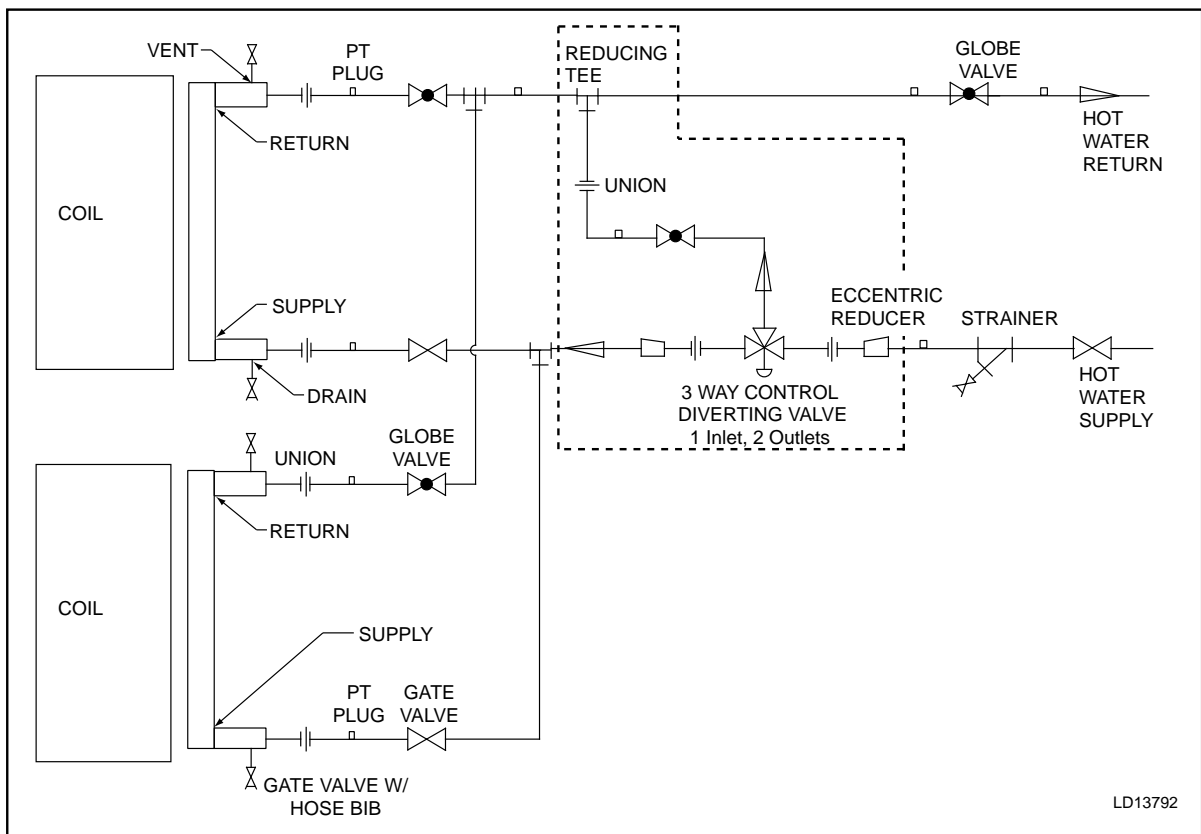


FIG. 2-70 – HOT WATER PIPING WITH DIVERTING VALVE Example - NOT for construction

WATER TREATMENT

Any copper tube coils may be attacked by acid condensate. The practice of boiler water treatment should include CO₂ removal to assure longer tube life.

Freeze Protection

Chilled water, hot water and steam coils can be damaged during freezing weather. Precautionary measures must be taken to prevent freezing such as:

- Positive coil freeze protection must be used in installations where any part of the water coil is subjected to temperatures of 32 degrees or lower. This may be accomplished by using a suitable antifreeze solution. If the coil is not in use, it is recommended that the coil be completely drained and the inside of the tubes blown dry with compressed air.
- After draining, flush coils with an antifreeze solution such as glycol. A solution of 50% glycol and 50% water will protect from freezing to approximately 35 degrees F below zero at sea level. *Also refer to ASHRAE and ARI guidelines.*
- During winter operation due to the possibility of shutdowns such as power failure, night shutdown and weekend shutdown, the controls should be installed so the return air dampers will go to the full open position, and all fresh air dampers go to the full closed position. A source of auxiliary heat must be maintained inside the unit cabinet.
- Other means of protection such as various electro-mechanical switches and the full constant flow of water can be used; however, Johnson Controls will not be responsible for any coils damaged by freezing.

STEAM

Refer to Fig. 2-71 "Steam Coil Piping Arrangements."

STEAM COILS

The operation of steam coils is dependent on airflow quantity and temperature. Consult the submittal issued for each specific unit for above information.

STEAM DISTRIBUTING COILS

Do not bush or reduce the coil return pipe size. Use a full size return pipe to the bottom of a dirt pocket. The supply pipe may be reduced at the coil connection if necessary. Install the coil casing level with the return down. A coil must be sufficiently elevated to allow a 12 inch minimum drop between the return connection on the coil and the trap. A greater than 2 inch drop is required for protection from freezing. The return main should be located below the trap. *Refer to Fig. 2-71.*

STEAM CONTROL

Continuous steam supply ensures long coil life and minimizes potential trapping, venting and freezing problems. A rapid cycling of the modulating steam supply or a frequent on-off steam supply control results in repeated thermal and piping stresses which will shorten the coil life. Modulating steam control valves must not be oversized but must be carefully selected. A substantial variation in the supply pressure will require the installation of a pressure-reducing valve ahead of the automatic control valve.

Light load operation with a modulated steam supply can be improved by the installation of a vacuum breaker check valve. An open relief line to the atmosphere from the return line near the coil is desirable, except on vacuum systems.

With a modulated steam supply, it is not practical to lift the condensate to an overhead return. Locate the coil well above the return, or provide condensate unit, or a boiler return trap below the coil.

Individual control valves are required on each coil installed in series with respect to airflow. When a modulating steam valve supplies two or more coils in parallel, with respect to airflow, the piping must be designed to provide for uniform steam distribution to each of the coils.

STEAM TRAPS

Float and Thermostatic (F. & T.) traps are recommended for all low or medium pressure applications. Use thermostatic traps only for air venting, for outdoor applications where an F. & T. trap might be subject to freezing. Use bucket traps only for a non-modulated steam supply. Size the steam traps in accordance with the manufacturer's recommendations (usually several times the steady state steam flow). Use the actual operating conditions (coil pressure vs. return pressure) for the selection of a trap.

It is preferable to provide an individual trap for each coil but a single trap may be used for coils operating in parallel with respect to the airflow. Coils in series with respect to airflow must be supplied with individual traps. Locate the trap at least 12 inches below the coil return connection and even lower when freeze protection is required. Do not attempt to lift condensate modulated steam supply.

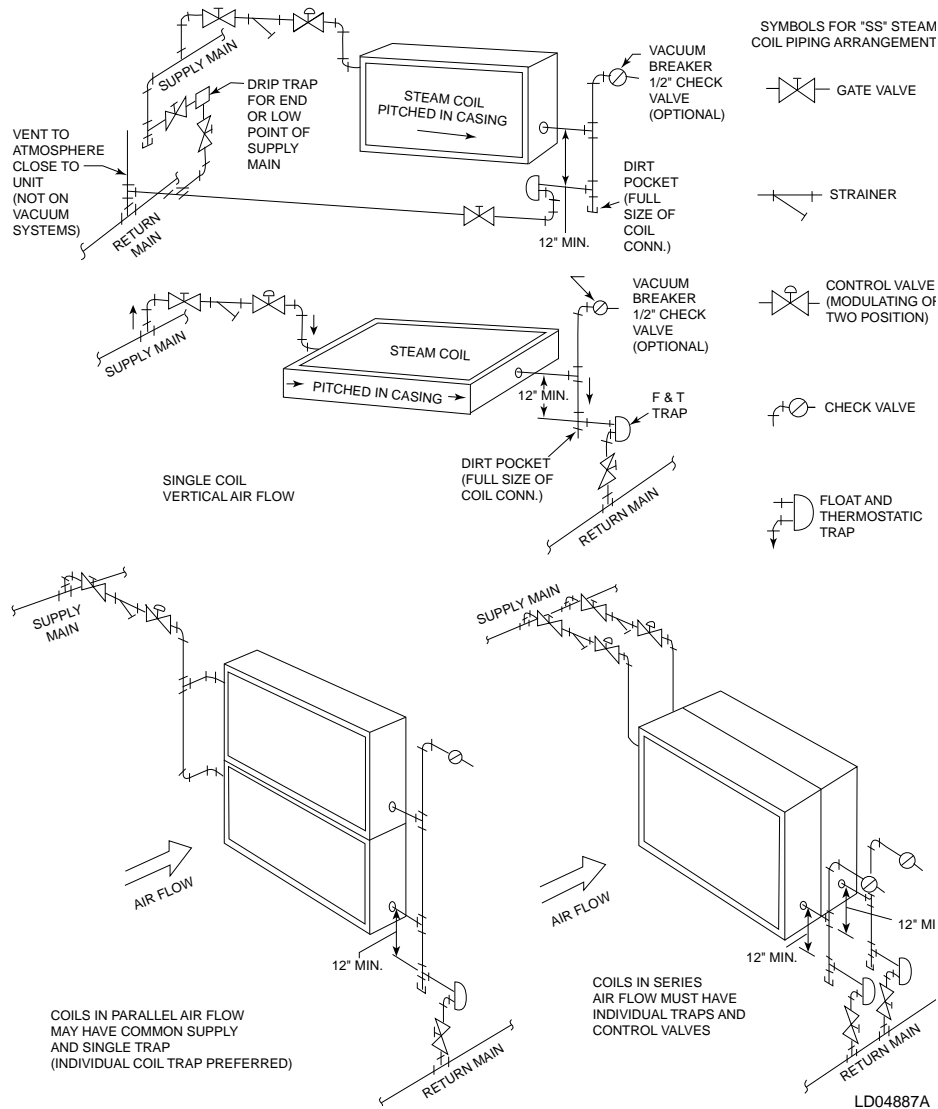
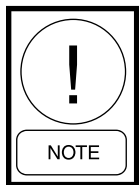


FIG. 2-71 – STEAM COIL PIPING ARRANGEMENTS

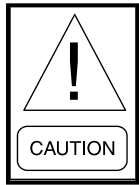


FIG. 2-72 – INTEGRAL FACE & BYPASS COIL (HORIZONTAL; TUBES, STEAM SHOWN)

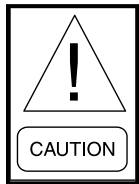
VIFB & IFB



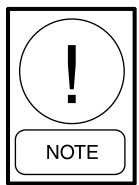
A complete IOM is provided with each IFB or VIFB coil unit.



VIFB lower header must be free to float. After coil has been piped, remove yellow colored bolts to allow header to float. Always “back up” on the coil connections when installing fittings.



VIFB Warranty will be voided should return piping on lower header (inlet and return on two-row header) not include flexible connector(s) and if lower header(s) bolts are not removed prior to use.



See IFB/VIFB manufacturer's IOM for additional piping details. Factory does NOT pipe connections to unit exterior.

Below 35°, the Vertical Tube Integral Face & Bypass (VIFB) or Integral Face & Bypass (IFB) operates with full steam pressure or full water flow at all times. This prevents freeze-up and temperature stratification.

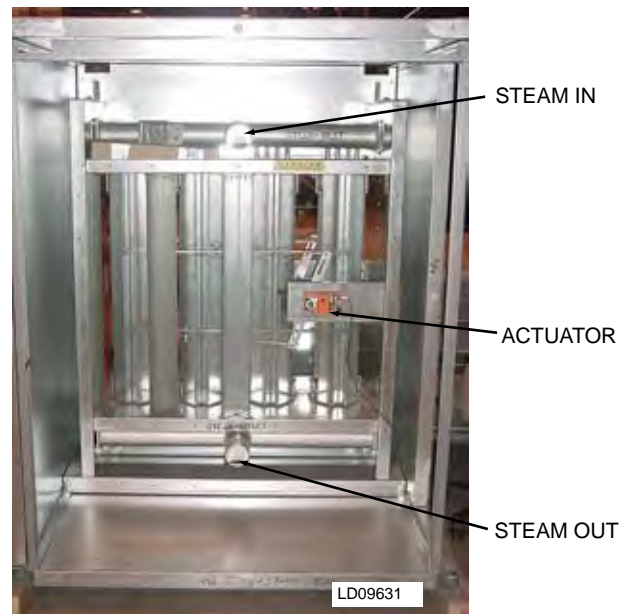
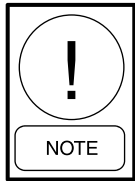


FIG. 2-73 – VERTICAL INTEGRAL FACE & BYPASS COIL (FACE MOUNTED ACTUATOR SHOWN)

Shipping Bolts (VIFB Only)

Return steam condensate headers or hot water supply and return headers are securely bolted to lower mounting brackets to prevent damage to header and tubes during shipment and piping of the coils. These bolts **MUST** be removed before applying steam or hot water but after all piping connections are made.

Piping Suggestions (VIFB & IFB)

See IOM Section 5, “Field Penetrations for Piping & Electrical Connections”. ▶

Steam and hot water field piping must be supported separately after the flexible connector to isolate piping strains and additional expansion from the coils.

Internal steam manifolds and piping should be insulated.

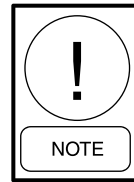
Steam traps should be sized for three times the calculated condensate loading at the coil design conditions, based on the pressure differential across the trap, **not the boiler pressure**. Traps should be of types that pass condensate and air at saturated steam temperature. Inverted bucket traps should incorporate thermostatic air vents.

Make return connection full size as required and reduce only at trap. Do not use reducing bushing on coil return connection.

Flexible Connectors (VIFB Only)

Return steam condensate headers, hot water supply, and return headers must be free to float. A flexible connector **MUST** be installed as close as possible to the coil to accommodate a minimum of 1/2” expansion movement of the headers.

Failure to install connectors will restrict expansion of the headers. This can result in bowing of tubes, bending of fins, interference with damper operation, or eventually tube breakage.

Freezing Conditions

Anti-stratification baffles are standard on all IFB and VIFB coils mounted in YORK Solution units.

The outside air and return air must be thoroughly mixed before passing over the coil. When freezing air enters only part of the coil, it creates a greater hazard than when the airflow entering the coil is of a uniform temperature.

Coils used in series with respect to the airflow must have individual controls with ample space between the coils for sensing devices, when required. Coils with two or more rows are more sensitive to freezing than single row coils.

On 100% O.A. capable applications, locate low limit at least 24" downstream of leaving edge of VIFB/IFB casing. Low limit element must cross both face and bypass areas, parallel to headers.

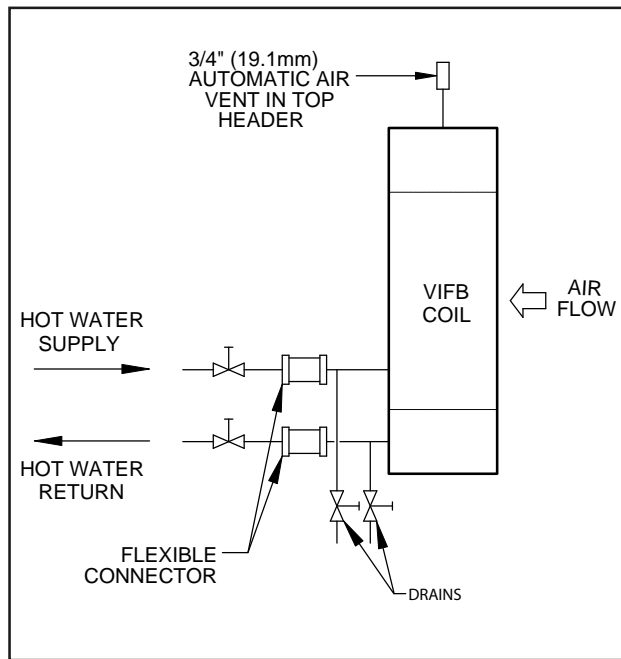


FIG. 2-74 – HOT WATER PIPING FOR 2 ROW COIL VIFB

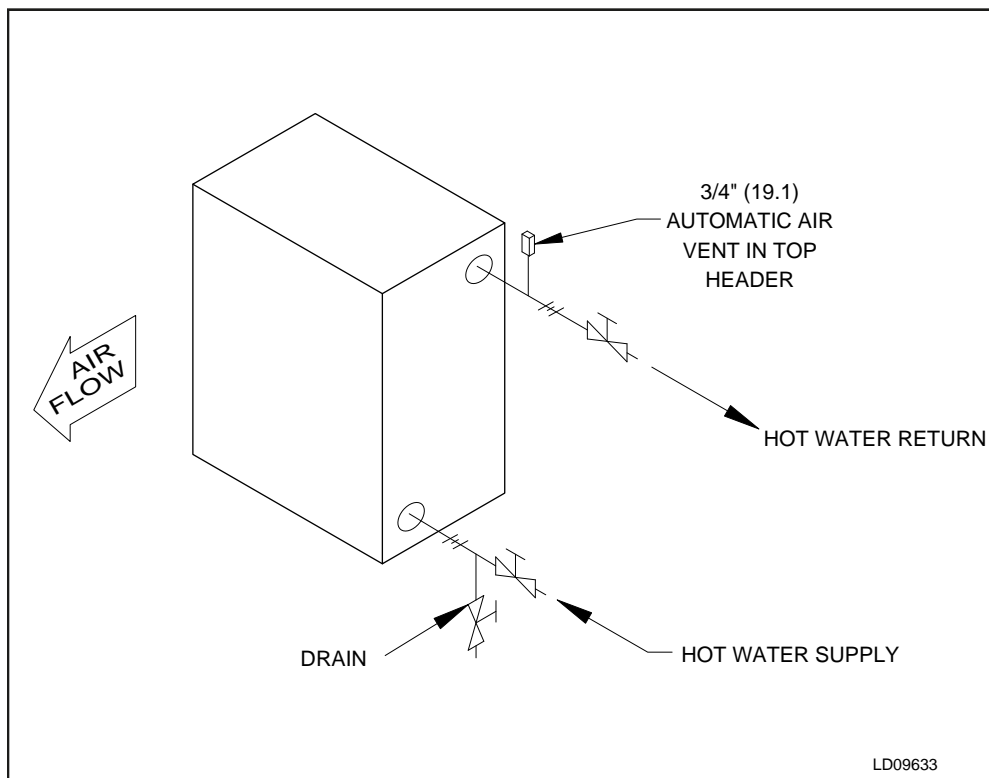


FIG. 2-75 – HOT WATER PIPING FOR IFB

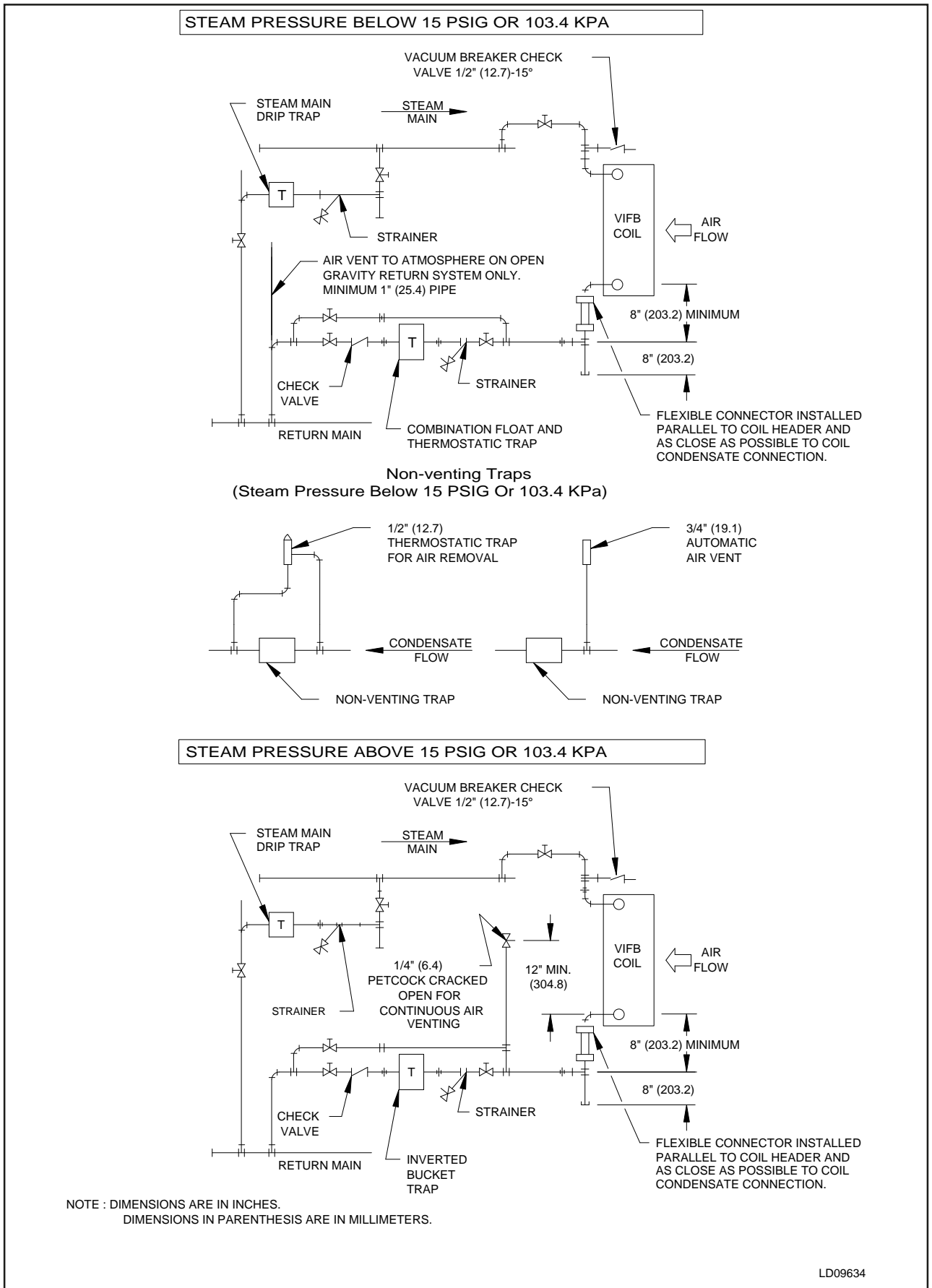


FIG. 2-76 – STEAM PIPING FOR VIFB COIL

REFRIGERATION

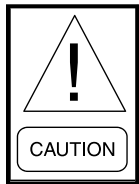
DIRECT EXPANSION COILS (DX)

DX coils are divided into splits depending upon the unit size and coil circuiting. Each split requires its own distributor nozzle, expansion valve and suction piping. Suction headers are on the air entering side with suction connection at bottom end of headers when the coil is properly installed. Matching distributor connections for each coil refrigeration circuit are on the air leaving side. See certified drawing and/or connection labeling to ensure correct matching of suction and distributor connections.

Do not leave piping open to the atmosphere unnecessarily. Water and water vapor are detrimental to the refrigerant system. Until the piping is complete, recap the system and charge with nitrogen at the end of each workday. Clean all piping connections before brazing joints.

The orientation of the refrigerant distributor is not critical but the distributor tubes must not be kinked or bent in a non-uniform configuration. For this and other piping & sundry tips, refer to Fig. 2-77.

The orientation of the refrigerant distributor is not critical but the distributor tubes must not be kinked or bent in a non-uniform configuration. For this and other piping & sundry tips, refer to Fig. 2-77.



Direct-expansion coils are shipped charged with nitrogen.

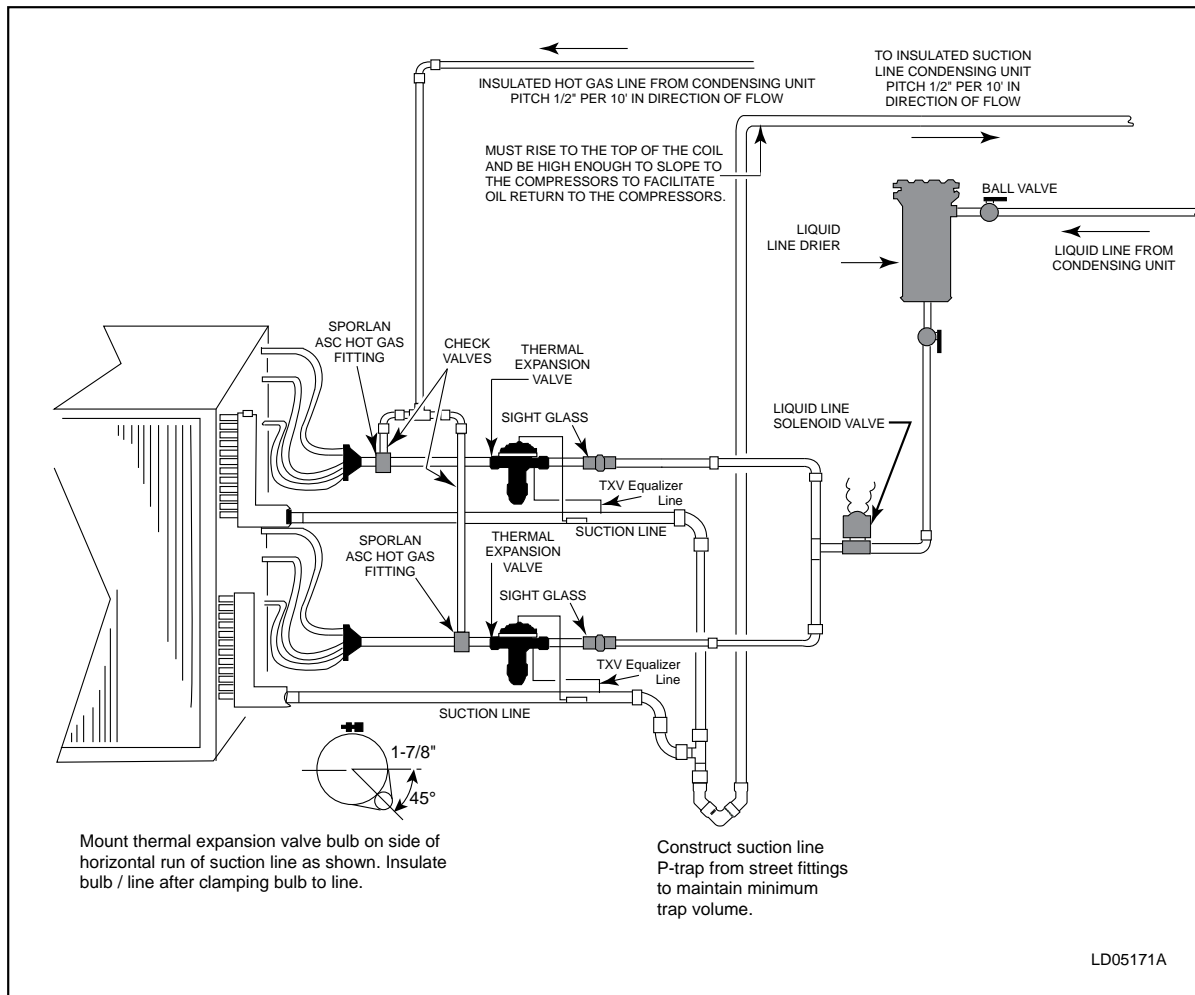


FIG. 2-77 – TYPICAL PIPING AND SUNDRIES AT THE DX COIL

DX COIL TYPES

There are three basic types of coil arrangements used in field erected split systems, interlaced, row split and face split.

Interlaced

Interlaced coils are the most desirable type of coil “field erected” designs. Interlaced coils ensure the entire face of the coil is active with any number of compressors operating. Interlaced circuitry interweaves coil tubing in both circuits across the entire face of the coil assuring uniform cooling of the air by the refrigerant. This type of coil also allows one circuit to operate while the other circuit is turned off. Interlaced coils provide excellent temperature control at full and part loads as well as good TXV superheat control. TXV control is essential for compressor reliability.

Row Split

Row split coils arrangements place coils back to back in the air stream. Air passes through one coil before passing through the next. Generally, the last coil in the air stream is activated first. Each circuit may be controlled independently in this arrangement. When both coils are operating, the coil closest to the leaving air will operate at a lower temperature. This type of coil may not permit lead lag of the circuits and it may be difficult to balance the capacity between the coils

Face Split

On a face split coil, the circuiting is divided between two separate coils. In field-erected systems, this arrangement may suffer from TXV superheat control problems and compressor reliability. At low airflow, low load situations, the TXV may have difficulty controlling system superheat.

Air stratification, poor humidity control and condensation on downstream components can also occur when using face split coils. One way to address TXV control at part load is to provide a face damper to shutoff airflow when a coil face is inactive.

COMBINED COIL TYPES

Coil types may be combined in some systems. This requires special care. Control sequences and piping tying the multiple systems and coils together should be well thought out and advice from an experienced design engineer is necessary.

DX COIL CIRCUITING

On many coil banks, two, or even all three of the methods of circuiting may be combined depending upon the cooling capacity and the level of control required. However, coil sections must be married or combined so that they provide for full-face operation (see Fig. 2-78).

There are numerous coil arrangements available from the Coil Marketing group as either standard designs or contract engineering SQ optional designs. The coil designs fall into the two following categories.

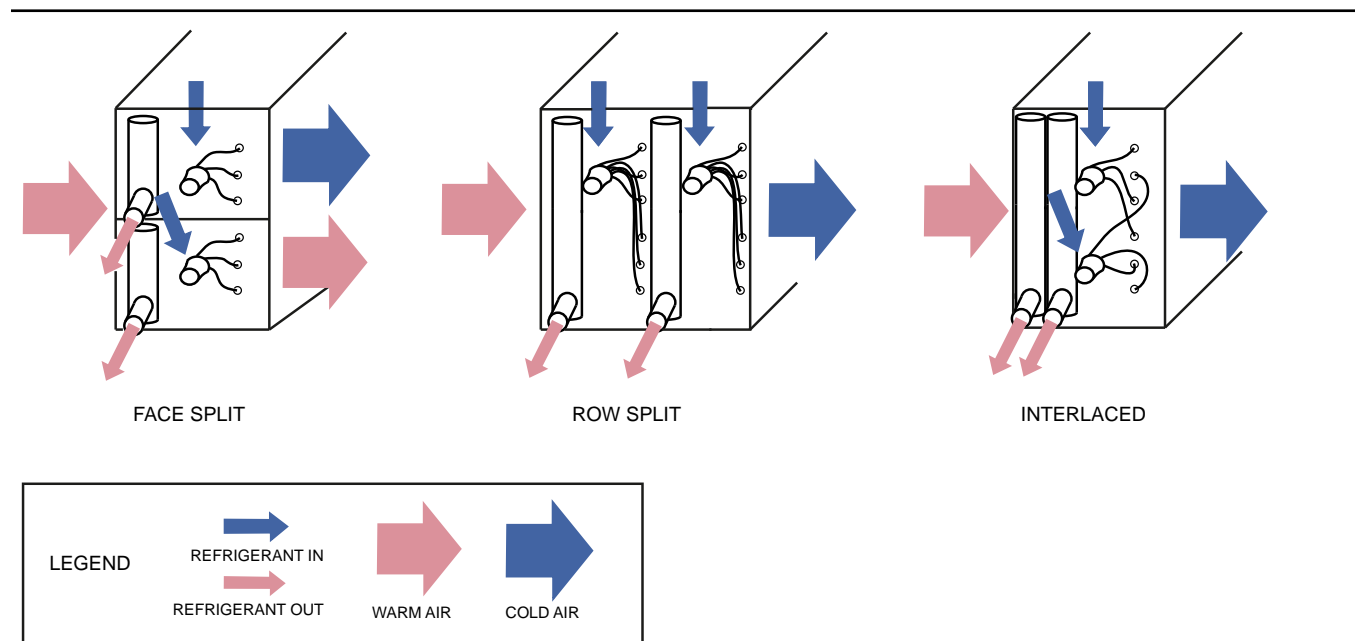
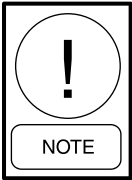


FIG. 2-78 – DX COIL CIRCUITING TYPES

| Coil Design | Fin Height |
|-------------|------------------|
| Non-stacked | 48" and less |
| Stacked | Greater than 48" |

Figs. 2-79 through 2-83 illustrate the available coil arrangements. Contact Coil Marketing for other arrangements not shown.



Face-split DX coils must be configured to provide full-face coverage at all condensing unit load steps. Johnson Controls assumes no responsibility for compressor failure if full-face coverage is not applied. Consult the factory, if application assistance is needed to convert split face to full-face operation.

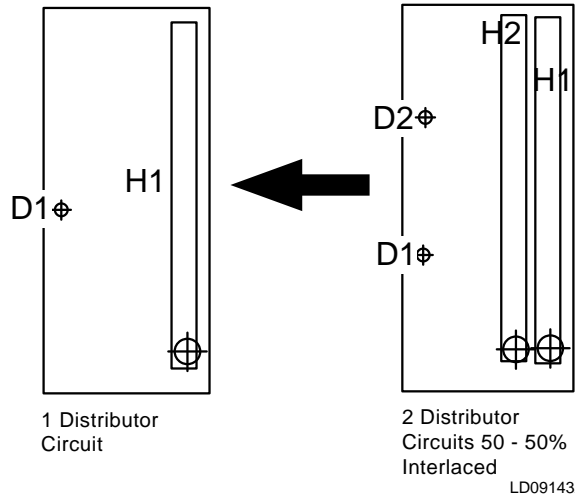


FIG. 2-80 – NON-STACKED COIL DESIGN - STANDARD

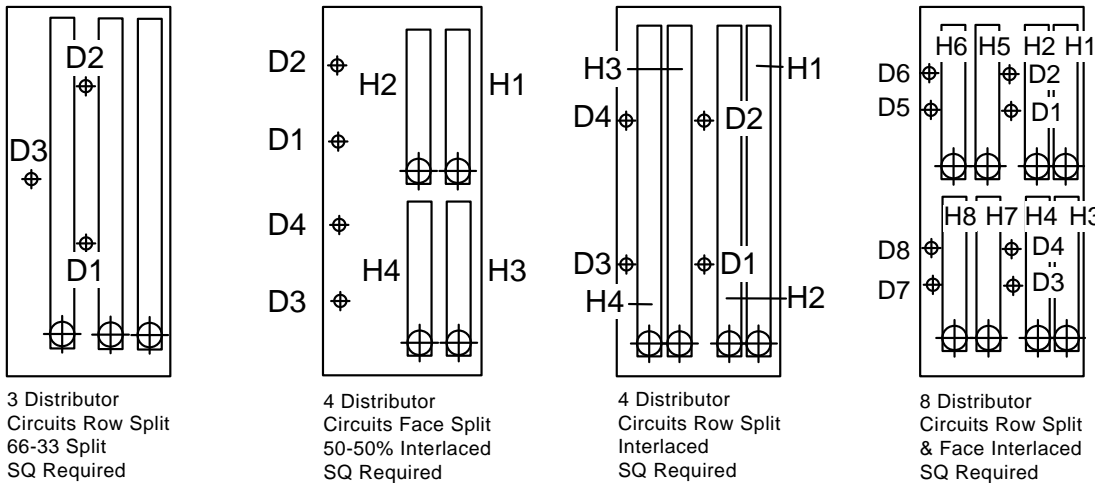
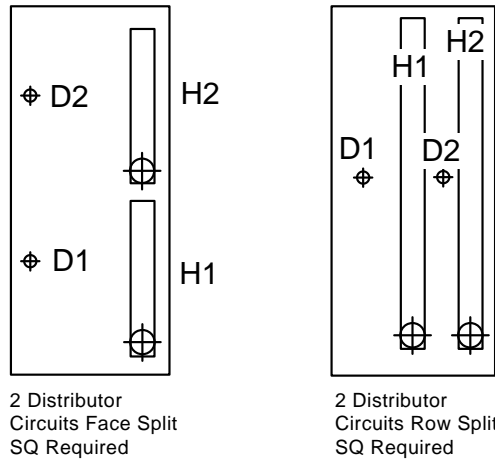


FIG. 2-79 – NON-STACKED COIL DESIGN - SQ SPECIAL

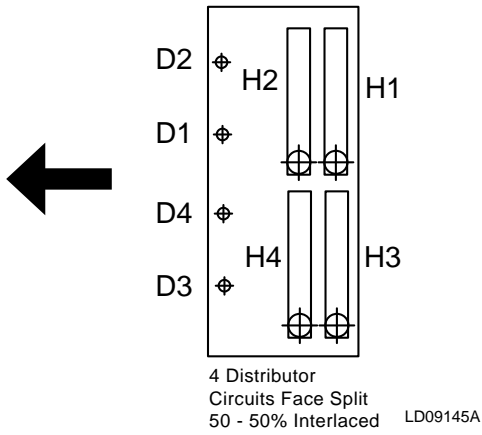


FIG. 2-81 – STACKED COIL DESIGN - STANDARD

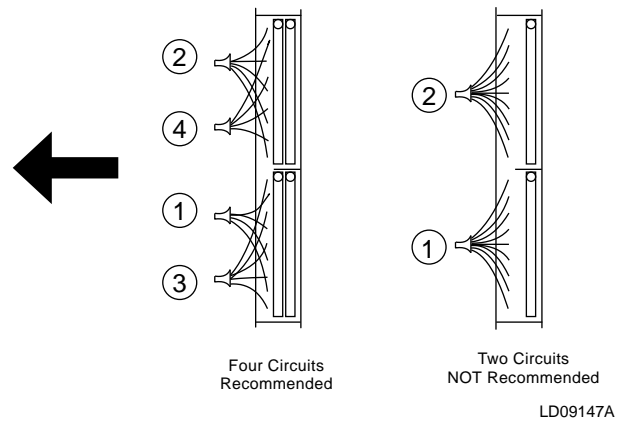


FIG. 2-83 – STACKED COIL CIRCUITING

DX COIL CIRCUITING AND STAGING

On stacked coils, a minimum of four coil circuits should be used to achieve full-face control (Fig. 2-83). Each coil distributor circuit requires its own Thermostatic Expansion Valve (TXV). Each condensing unit circuit requires its own liquid line solenoid valve (LLSV). When the condensing unit has two compressors per refrigerant circuit, either one or two coil circuits may be used for each refrigerant circuit depending upon the cooling capacity.

If one coil circuit is used (Fig. 2-84), the LLSV and TXV must be sized to handle the full capacity of the refrigerant circuit. When two coil circuits are used per refrigerant circuit (Fig. 2-85), each TXV should be sized to handle half of the capacity of the refrigerant circuit and the LLSV should be sized to handle the full capacity of the refrigerant circuit.

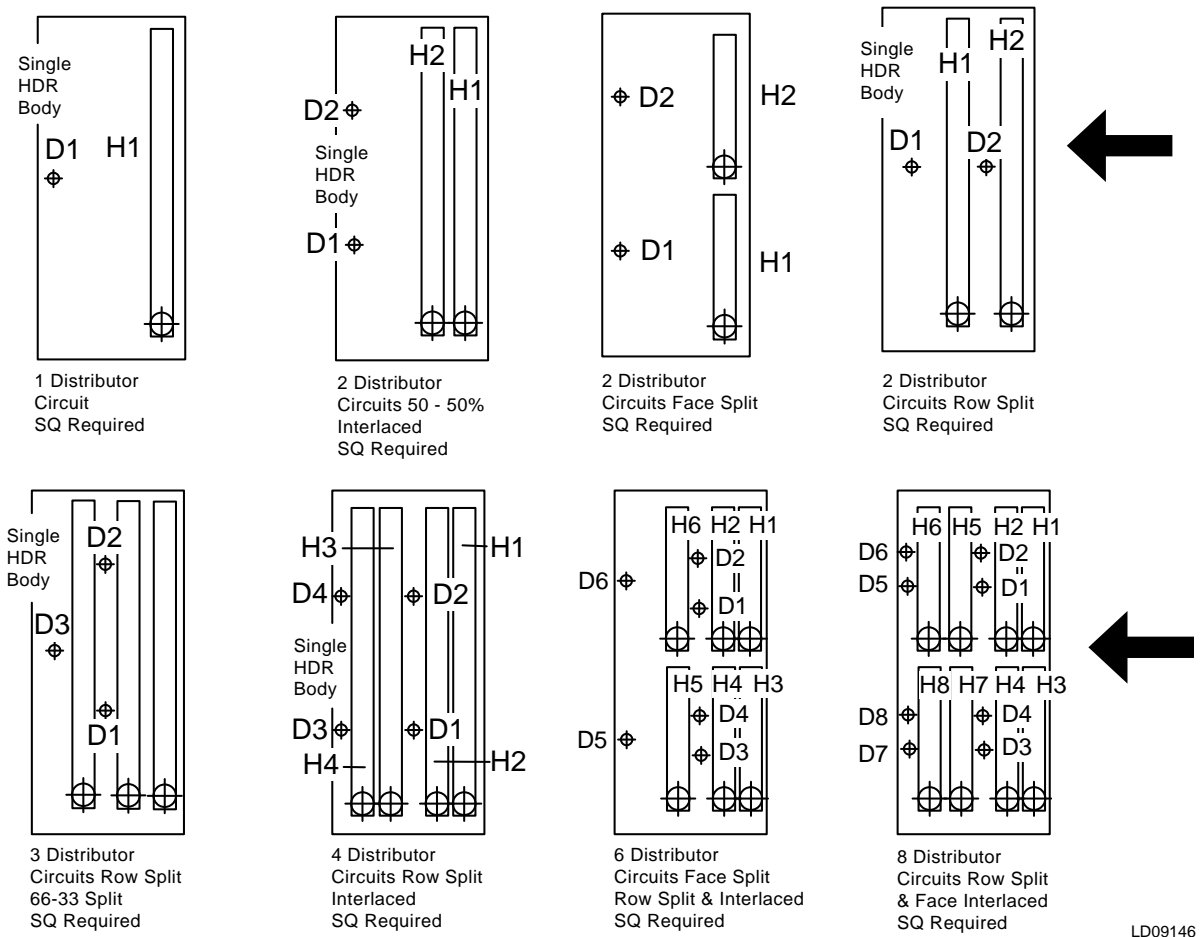


FIG. 2-82 – STACKED COIL DESIGNS - SQ SPECIAL

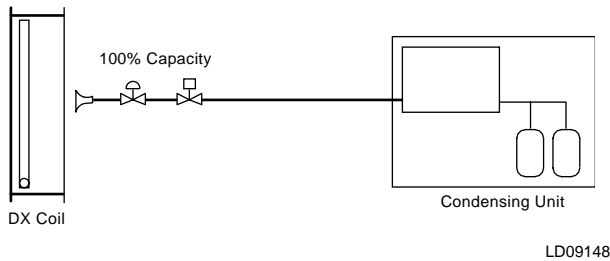


FIG. 2-84 – ONE COIL CIRCUIT PER REFRIGERANT CIRCUIT

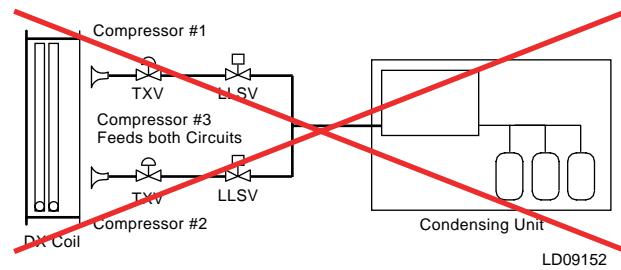


FIG. 2-88 – DO NOT USE THE ABOVE CONFIGURATION.

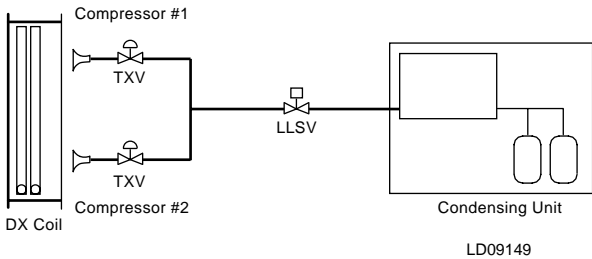
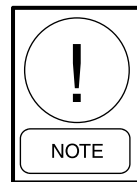


FIG. 2-85 – TWO COIL CIRCUITS PER REFRIGERANT CIRCUIT



When sizing TXV's, each TXV must be sized for the refrigerant circuit tonnage divided by the number of DX coil liquid distributors. The TXV should be equal to or smaller than the calculated value.

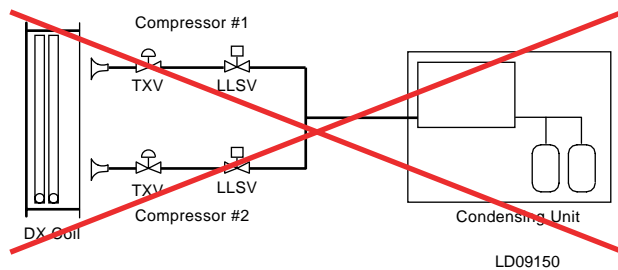


FIG. 2-86 – DO NOT USE THE ABOVE CONFIGURATION.

When the condensing unit has three compressors per circuit, two coil circuits should be used for each refrigerant circuit (Fig. 2-87). Each coil circuit must have a dedicated TXV and distributor to handle one coil circuit and the LLSV should be sized to handle the full capacity of the refrigerant circuit. The hot gas bypass line should be connected to all of the distributors in the coil circuit.

The first three compressors (see Fig. 2-89) would be tied into LLSV1, TXV1 and TXV2. This would provide full-face control of the coil at even the lowest cooling loads. Both distributors on each of the coil circuits would include auxiliary side connectors for HGBP.

The second set of 3 compressors would be tied into LLSV2, TXV3 and TXV4 to maintain full-face control at higher loads. Reference Form 050.40-ES3 Section 9 for compressor staging solutions.

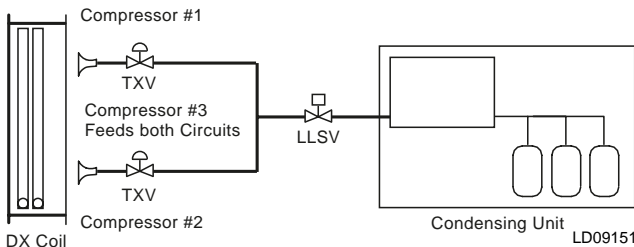


FIG. 2-87 – THREE COMPRESSOR YCUL

The more control stages used, the more precise the control of the air temperature will be. Smaller incremental changes in capacity will result in a more consistent DX coil leaving air temperature. This will eliminate temperature swings in the conditioned space and improve the comfort level, but more importantly, a consistent space temperature is crucial to many process applications. The smaller changes in capacity that result from using a greater number of control stages will also extend equipment life. The most important thing to remember is to maintain full-face control of the coil at all cooling loads. When row split coils are used, make sure that the first LLSV is energized with the last coil circuit in the leaving air stream. This is always the last one de-energized too.

In the case of a stacked coil with four coil circuits piped to a condenser with six compressors, the coil circuits would be face-split and interlaced with two interlaced circuits on the lower coil section and two on the upper (Fig. 2-89).

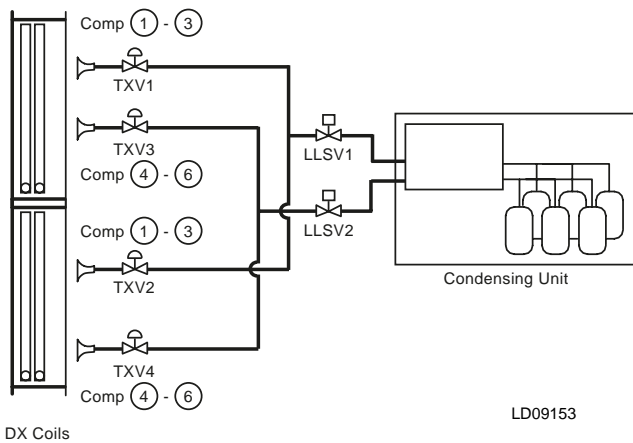


FIG. 2-89 – SIX COMPRESSOR YCUL

THERMOSTATIC EXPANSION VALVES (TXV)

Each coil distributor circuit requires its own Thermostatic Expansion Valve (TXV). Each condensing unit circuit requires its own liquid line solenoid valve (LLSV). TXV's are to be equipped with external equalizer tubes that are field connected to the suction line. The valve should be sized in accordance with the valve manufacturer's recommendations, allowing approximately 35 PSI pressure drop throughout the coil and distributor at full load. Do not oversize the valve. Follow the valve manufacturer's instructions on the location of the thermostatic bulb. Proper expansion valve operation is necessary in order to realize the rated coil capacity.

When a DX type coil is operated with a suction temperature below 32°F, a buildup of frost will occur on the finned surface. It is not recommended therefore, to operate DX coils for air conditioning purposes at below freezing suction temperatures. If the full load operating point for the coil is selected at a "safe" temperature, a system analysis is required to check for the lowest probable suction temperature at light load conditions.

HOT GAS BYPASS

When using discharge air temperature control or systems with outside air economizer cooling, always include hot gas bypass (HGBP). It is not as critical to use HGBP with return duct air temperature control, or suction pressure control, but it provides better capacity control at low loads.

The venturi type distributor furnished with YORK DX coils may be ordered for field application of a hot gas bypass valve. The connection may be made through a tee installed in the field between the expansion valve and distributor. The system balance point and control adjustments must assure compressor cooling and avoid excessive compressor cycling. Refer to Form 50.40-ES3, Section 3. ►

MAINTAINING ADEQUATE AIRFLOW

An electrical interlock between the air handler and the condenser must be included for permissive run of the condenser. In addition, a differential pressure switch mounted across the supply fan must always be included to ensure airflow across the coil before the condensing unit is energized. The condenser must never be operated unless the air handler fan is operating and air is flowing across the active coil. Insufficient airflow will result in liquid refrigerant returning to the condensing unit, which could damage the compressors by liquid slugging or washing oil from the bearing surfaces.



In variable volume systems, the minimum acceptable airflow for fixed speed or VAV systems is 350 FPM face velocity across each DX coil, as applied to split DX systems. This is critical to assure that the TXV does not overfeed, causing compressor failure.

The air velocity flowing through chilled water and direct expansion coils must not exceed specific recommended values, to prevent water carryover.

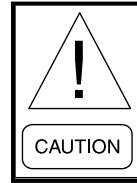
VAV SYSTEMS

Overhead variable air volume systems have been the preferred method of air distribution since the early 1970 's. Overhead VAV systems offered greater energy efficiency and better control of building diversity than constant volume systems. Unlike a constant volume system, in which the leaving air temperature is adjusted to satisfy the cooling load, in a VAV system the air temperature remains constant and the air volume is varied to meet the cooling requirements.

There are four basic components in a VAV system - an air-handling unit with airflow control (i.e. variable-speed drives), VAV boxes, zone thermostats and duct static pressure sensors. All of these components must work together to provide good temperature control and a comfortable environment. The zone thermostats control the VAV boxes. As the zone temperature increases, the VAV boxes open to allow greater airflow into the space and as the zone temperature decreases, the VAV boxes close to decrease the airflow to the space.

As the VAV boxes in the system open and close the static pressure in the ductwork changes. When a box opens, the duct static pressure decreases, and when a box closes, the duct static pressure increases. The duct static pressure sensor controls the air handling unit supply fan. Since an increase in duct pressure relates to a decrease in the zone airflow required, the supply fan volume decreases in response. Conversely, a lower duct static pressure indicates a need for increased zone airflow; therefore, the supply fan volume increases in response. The change in supply air volume is accomplished using a Variable Frequency Drive or similar device.

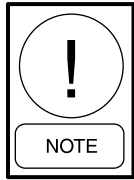
In the air-handling unit a decrease in airflow through the DX coil will result in a corresponding decrease in the suction gas pressure while an increase in airflow will result in an increase in the suction gas pressure. Since the system is designed to maintain a constant suction gas pressure, the compressors will be staged on or off as needed to meet the increase or decrease in load demand. The system should be designed to operate smoothly avoiding transients that could upset system balance and cause liquid flood back.



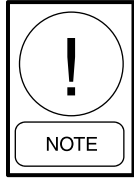
Problems can arise if the airflow decreases more quickly than the compressor control can respond to the load change. Therefore, airflow should never change at a rate faster than 3% per minute on VAV systems.

This limitation will promote stable control of the system and minimize fluctuations in zone temperature. Under any circumstances, a minimum of 350 FPM face velocity across the coil must be maintained for DX split systems.

DRAINS AND TRAPS



Heat trace and insulate traps where there is a risk of freezing to prevent blockage and/or damage due to freezing of the liquid in the trap.



Auxiliary drain pans may not require traps. If the trap is not in constant use the water seal may evaporate causing air passage into or out of the air handler. In such cases it is recommended to cap the drain in a manner that allows opening or closing of the drain depending on its use.

CONDENSATE DRAIN PIPING

The majority of cooling coils are located in the units so that the supply air is drawn through them. This results in the condensate being subjected to negative (-) static pressure. Unless some means of pressure equalization is provided in the condensate drain, the air rushing back through the drainpipe will cause the condensate to build up in the drain pan. As the unit continues to operate, the accumulated water will be carried with the air stream, overflowing the drain pan causing possible water leaks into the supply duct and/or causing water damage in the building. A trap must be installed to prevent this condensate water build-up (see Figs 2-90 and 2-91).

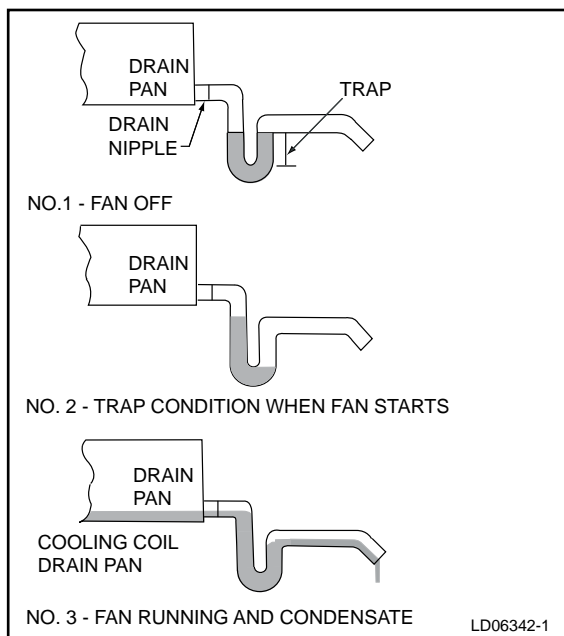


FIG. 2-90 – DRAIN TRAP SHOWING WATER LOCATION DURING DRAW THROUGH OPERATION STAGES

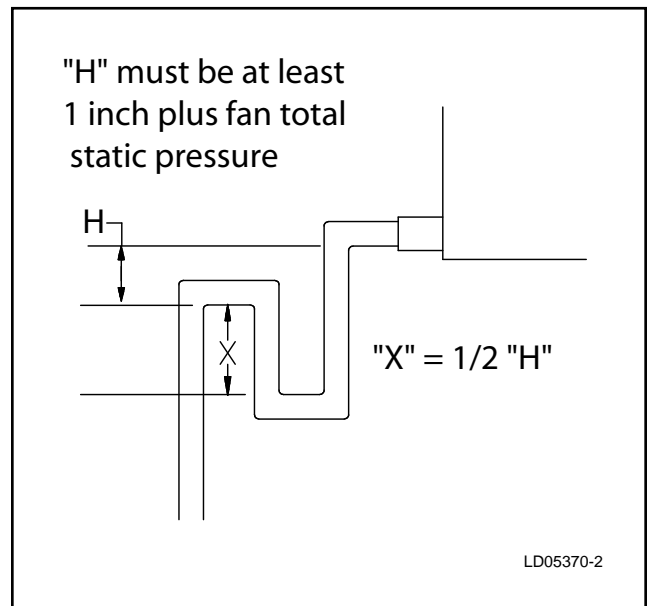


FIG. 2-91 – TRAP DETAIL FOR DRAW THROUGH APPLICATION

CONDENSATE DRAIN TRAP

For "Draw Through" applications install a trapped condensate drain line at unit drain connection (see Fig. 2-91) according to all governing codes. "H" dimension must be at least 1 inch greater than design Total Static Pressure (TSP) of fan. This ensures proper drainage even if filters clog or dampers malfunction.

For "Blow Through" applications, the same principles apply, but the leaving pipe must be as shown in Fig. 2-92 for proper trap design.

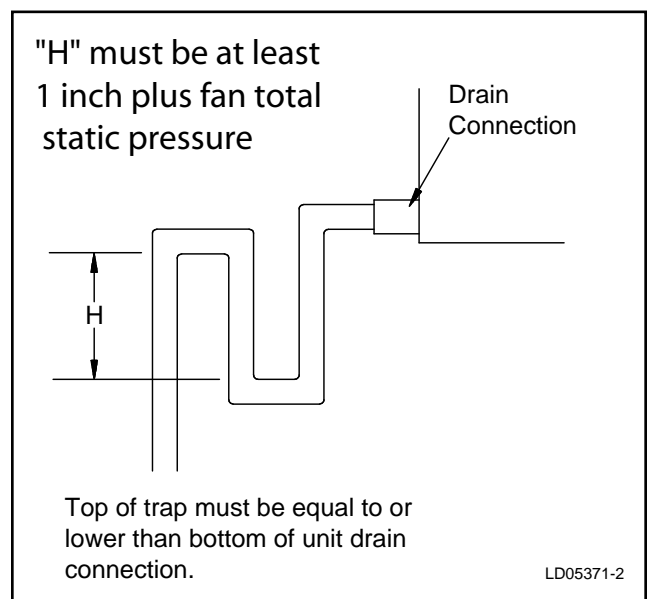


FIG. 2-92 – TRAP DETAIL FOR BLOW THROUGH APPLICATION

Two or more drains on same side of unit must be trapped individually before drain lines can be combined and routed to a suitable drain (see Fig. 2-93).

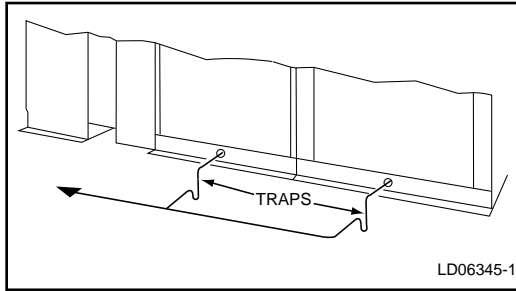


FIG. 2-93 – COMBINING DRAIN LINES

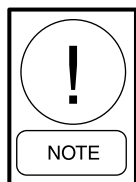
If distance from drain pan outlet to trap exceeds 10', install additional clean outs for each 10' segment of horizontal drain line (min. 1/4 in. per foot fall required).

On initial startup, it may be necessary to fill the trap manually.

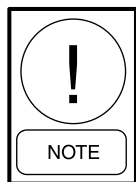
ELEVATING UNIT FOR GRAVITY FLOOR DRAIN CONNECTIONS

On indoor units, the installer must provide a means of pumping or draining coil condensate water away from the unit. The installer may have to elevate the unit to provide space below the condensate drain of the unit to install properly designed drain trap(s) to permit gravity flow of condensate water from the drain pan (see Figs 2-3, 2-4 & 2-5).

DUCT CONNECTIONS



Duct must have positive seal to unit openings. Outdoor baserails are available in 3", 6", 8" & 10" heights. Contractor is responsible for providing ductwork to include baserail height.



All ductwork should be supported independently from the unit.

DUCT CONNECTION GUIDELINES

See Fig. 2-94.

Duct connections to the unit may be made directly except when the unit has external isolation. Then duct connections should be flexible material and should be installed so they are sufficiently loose. Duct connections should be designed and installed according to AMCA Standards 200 & 201 as a minimum. Duct turns and transitions must be made carefully to hold friction loss to a minimum. Avoid short turns. Duct elbows should contain splitters or turning vanes.

The Effective Duct Length connected to the fan or unit discharge should run in a straight line for at least 2.5 Equivalent Discharge Diameters* for up to 2500 FPM fan outlet velocity and one additional diameter for each additional 1000 FPM fan outlet velocity. This ductwork should be no greater than 105.5% or no less than 85.5% of the discharge area. In addition, the slope of the transition elements should not be greater than 15% for converging elements, or greater than 7% for diverging elements.

* To find the Equivalent Discharge Diameter:

$$EDD = \sqrt[3]{4ab/\pi}$$

The letters "a" and "b" represent the height and width of the discharge.

A duct turn should be in the same direction as the fan rotation. Never deadhead the discharge into the flat surface of a plenum.

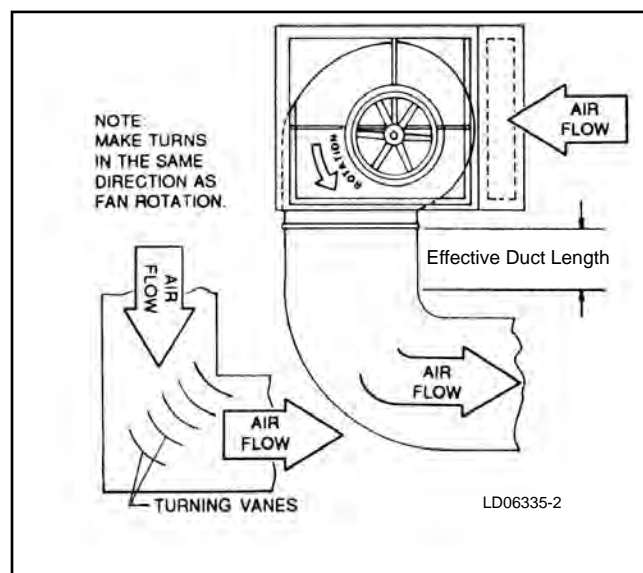
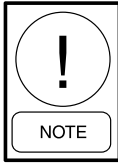


FIG. 2-94 – RECOMMENDED DISCHARGE DUCT ARRANGEMENT WHEN TURNS ARE REQUIRED

DUCT CONNECTIONS



Ducts must have positive seal to unit openings.

Installer is responsible for providing ductwork to include base rail height for curb mounted units.

All duct work is to be supported independent of the connection to the unit.

If the entire unit is mounted on isolation, the duct connection is to be flexible.

This instruction is suitable for bottom, end, side and top connections. Top connections on Outdoor units are not recommended.

FLANGED DUCTS OR SLEEVES:

To use flanged duct or sleeve be sure there will be access on all four sides to fasten the flange completely.

Flanged ducts can be connected with self drilling screws directly to the unit with gasket or sealant between unit and duct flange.

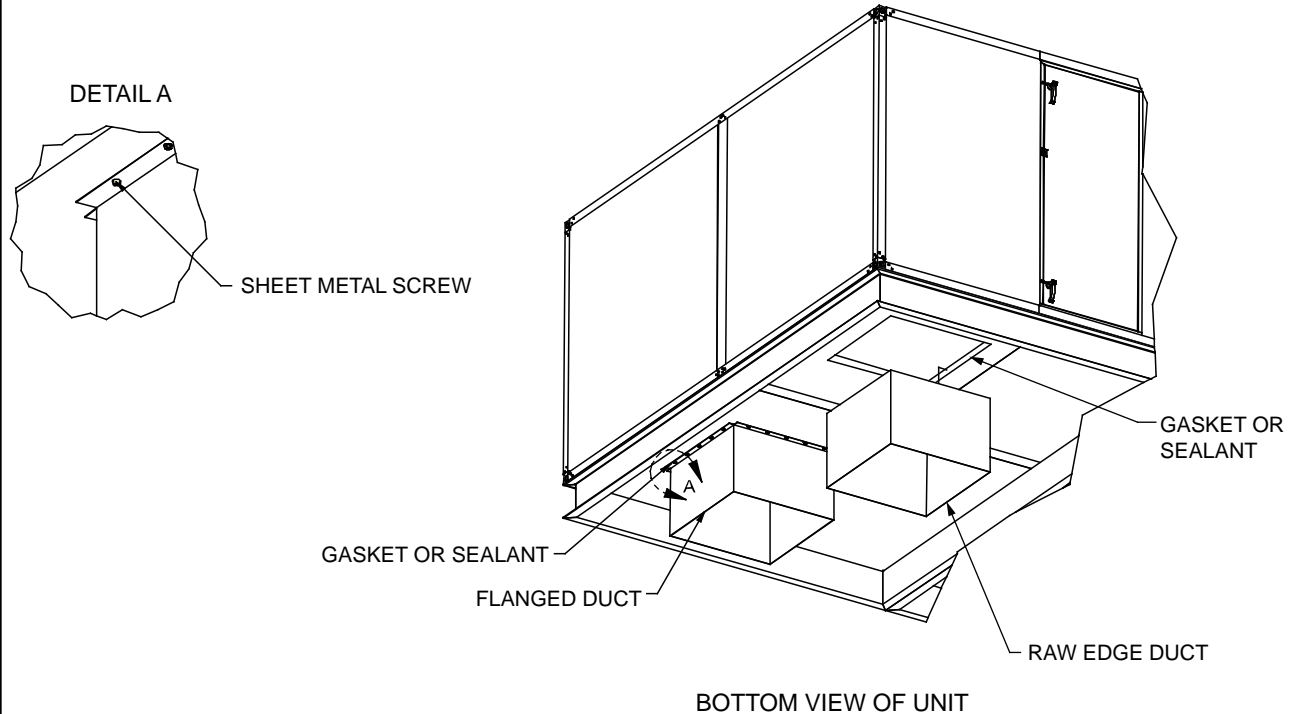
A flanged sleeve may be dropped through the opening, provided there is access to seal & fasten the flange to the unit interior surface.

RAW OR STRAIGHT EDGE DUCTS OR SLEEVES

The duct opening on the unit is located in a panel that is approximately 2" thick. The inside of the opening (2" surface) is suitable for attaching ducts.

If access is not available from inside the unit, access may have to be from inside the duct or sleeve.

Raw or straight edge ducts can be connected with self drilling screws directly to the unit with gasket or sealant between unit and duct.



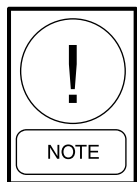
LD14087

FIG. 2-95 – RECOMMENDED DISCHARGE DUCT ARRANGEMENT WHEN TURNS ARE REQUIRED

The performance ratings of coils will be met only if the airflow is uniform over the face of the coils. High air velocity spots on the coil may cause the carry-over of moisture from the coil. High or low air velocity areas of the coil will not deliver the published ratings. The duct connections must be designed to provide for uniform flow of air across the face of the coil. The entering duct must provide a smooth transition from any high velocity effects. Stratifications of outside and return air, especially where below freezing outside air enters, must be avoided to prevent coil freeze-up or nuisance low limit trips.

SOUND AND VIBRATION TRANSMISSION

All roof mounted air-handling units generate some sound and vibration that may or may not require some special treatment of the air-conditioned space. The noise generated by the air-handling unit is dependent on the speed of the fan, the amount of air the fan is moving, the fan type and the static efficiency of the fan. In applications where sound and vibration transmissions may be objectionable, good acoustical engineering practices must be incorporated in the system design.



On units with return fans, it is especially important to consider the effects of sound transmission into the conditioned space.

When a unit is used with a ceiling plenum return air system, sound may be transmitted from the unit through the ceiling to the conditioned space. For such applications, there should be a sound absorption chamber installed near the unit return air inlet. Various reference sources are available regarding acoustic design.

FRONT AND REAR DISCHARGE OUTDOOR UNIT DUCT INSTALLATION

- Roof penetrations by ducts should utilize counter flashed curbs. (Typical arrangements are shown in Fig. 2-96.)
- All penetrations into ducts should be sealed watertight. Attachment of supports should use a minimum number of duct penetrations.
- Duct systems should not be pressurized without sufficient time for curing of sealant systems. Follow sealant manufacturer's recommendations for application of the sealant.

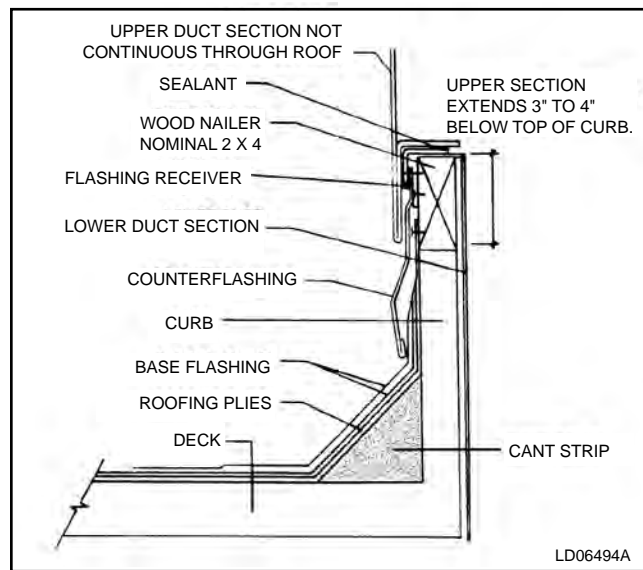


FIG. 2-96 – DUCT PENETRATION OF ROOF

- Adequate clearances between ducts and roof penetration openings should be provided.
- Ducts should be supported to avoid transfer of duct weight across flexible connections (see Fig. 2-97).
- Horizontal ducts should be pitched and provided with drainage outlets as illustrated (by the system designer).
- Ducts should be installed at a height sufficient to install roofing and flashing.
- See *Duct connection guidelines on previous page.*

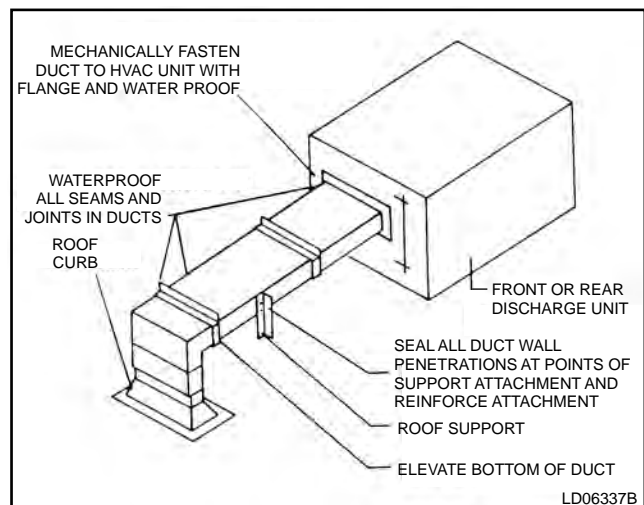
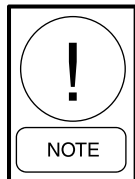


FIG. 2-97 – ROOF TO DUCT INSTALLATION - HORIZONTAL DISCHARGE

AIR FILTERS

It is mandatory that filters be in place in the filter frames of each unit before putting the unit into operation to protect the coils and keep them clean.

Due to the wide variety of filters, it is not possible to cover all of them in this section.

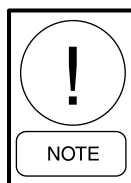


Be sure to install all filters in the correct orientation with regard to airflow and with pleats or pockets vertical wherever possible. See IOM Section 4, "Filter Segments". ►

Most YORK Solution air handling units will be shipped without filters. The Johnson Controls Sales office is responsible for the order and delivery of filters in a timely manner. It is important for the contractor or commissioning agent to be in touch with Johnson Controls regarding this issue. Various filter types will have different lead times.

Filter clips if required will be shipped with the first filter shipment, except for HEPA filters, in which case the filter clips will be attached to the filter racks inside the unit. Filter clips are not required for side load filter arrangements.

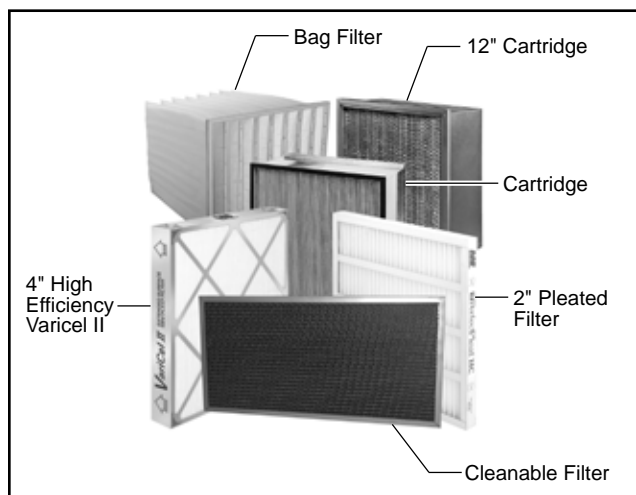
Contractor is responsible for installation of filters. Contractor is responsible for freight claim if filters arrive damaged. Other issues such as size, type, spares, replacements or quantity should be addressed with the Johnson Controls Sales office or project manager.



A list of filter part numbers, sizes and quantities are shown on a label located on each filter segment of each air handler.



If your unit has HEPA filters the filter frames, filter bulkheads and filter segment panels are factory sealed and must remain sealed for NO air bypass.



LD09650

FIG. 2-97A – TYPICAL FILTERS

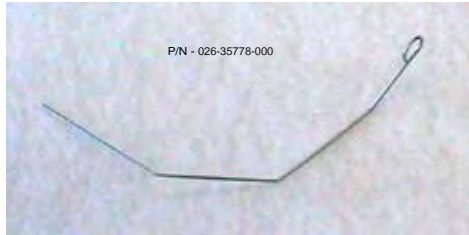
FILTER TYPES

Flat, angle, rigid, bag, HEPA & charcoal.

MAINTENANCE AND REPLACEMENT

Every month, check the cleanliness of the filters and replace. Filters should be replaced when the pressure drop, measured by a manometer, reaches the prescribed limits for the installation.

FILTER LATCHES



NOTE: Typically when filters are by others, so are the filter clips.

Used with 2" Perfectpleat, Premium or Premium HM and SH Single Headered Filters.



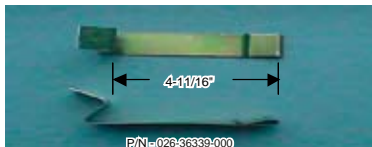
Used with 2" (C86) & 4" (C89)" Amair 300 X Pleated Prefilter in combination with a Single Header Final Filter.



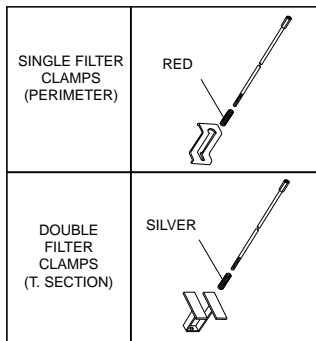
Used with 2" & 4" Prefilter in combination with a Double Header Final Filter and Varicel DH Double Headered Filter.



Used with 2" Prefilter in combination with a Double Header Final Filter.



Used with 4" Prefilter in combination with a Double Header Final Filter.



Used to attach HEPA Filters to Holding Frame.

Used to attach HEPA Filters to Holding Frame.

LD13303C

FIG. 2-98 – FILTER LATCHES

YORK MATRIX: FILTERS AND FILTER FRAMES / LATCHES

| Single Filter Application | | | | |
|---|--|---------------|---------------------------------|------------|
| | 2" PerfectPleat, Premium or Premium HM | 4" AmAir 300X | VariCel SH or DriPak 2000 | VariCel DH |
| FILTER FRAME 12x24 - 16 ga. Galvanized | | | | |
| P/N 026-35778-000 | X | | X | |
| P/N 026-35778-007 | | X | | |
| P/N 026-35778-006 | | | | X |
| FILTER FRAME 24X24 - 16 ga. Galvanized | | | | |
| P/N 026-35778-000 | X | | X | |
| P/N 026-35778-007 | | X | | |
| P/N 026-35778-006 | | | | X |

| Prefilter / Final Filter Application | | | | |
|---|--|--|---|---|
| | PerfectPleat, Premium or HM <u>AND</u> VariCel SH or DriPak 2000 | PerfectPleat, Premium or HM <u>AND</u> VariCel DH | 4" AmAir 300X <u>AND</u> VariCel SH or DriPak 2000 | 4" AmAir 300X <u>AND</u> VariCel DH |
| FILTER FRAME 12x24 - 16 ga. Galvanized | | | | |
| P/N 026-35778-007 & 026-35778-000 | X | | | |
| P/N 026-35778-006 & 026-36339-001 | | X | | |
| P/N 026-35778-007, 026-35778-008 & 026-35778-000 | | | X | |
| P/N 026-35778-006 & 026-36339-000 | | | | X |
| FILTER FRAME 24X24 - 16 ga. Galvanized | | | | |
| P/N 026-35778-007 & 026-35778-000 | X | | | |
| P/N 026-35778-006 & 026-36339-001 | | X | | |
| P/N 026-35778-007, 026-35778-008 & 026-35778-000 | | | X | |
| P/N 026-35778-006 & 026-36339-000 | | | | X |

NOTE: Typically when filters are by others, so are the filter clips.

INSTALLATION OF 2” PERFECTPLEAT, PREMIUM OR PREMIUM HM

These instructions are for installing a 2” filter (typically PerfectPleat) into 16 ga. galvanized holding frames.

- Latches needed for these applications are four (4) P/N 026-35778-000, as shown in Fig.2-98.
- A single latch should be installed at each of the four (4) corners of the frame.
- The latch fits into the set of knockouts, which consists of two (2) rows of three (3) knockouts. The row of knockouts closest to the gasketing should be used for nominal 1” filters or filters with a 13/16” single header. The second set of knockouts should be used for nominal 2” filters.

Installation of Spring Latches

1. Insert the straight end of the latch between the two (2) knockouts furthest from the corner.
2. Using a moderate amount of pressure, force the latch over the third knockout.
3. The latch installation should now be complete. The latch should now be “trapped” within the three (3) knockouts, but should be able to freely rotate (see Fig.2-99).



FIG. 2-99 – CORRECTLY INSTALLED LATCH P/N 026-35778-000.

Repeat the installation process with the remaining latches in the other three corners.

4. Rotate all of the latches outward, and insert the filter into the frame.
5. After the filter has been placed into the frame, grasp the circular end of the latch and rotate it across the corner of the filter.
Push the end of the latch towards the filter, until the latch catches beneath the knockout on the frame.
Repeat for the remaining latches.
6. The filter should now be securely installed into the frame (see Fig.2-100).

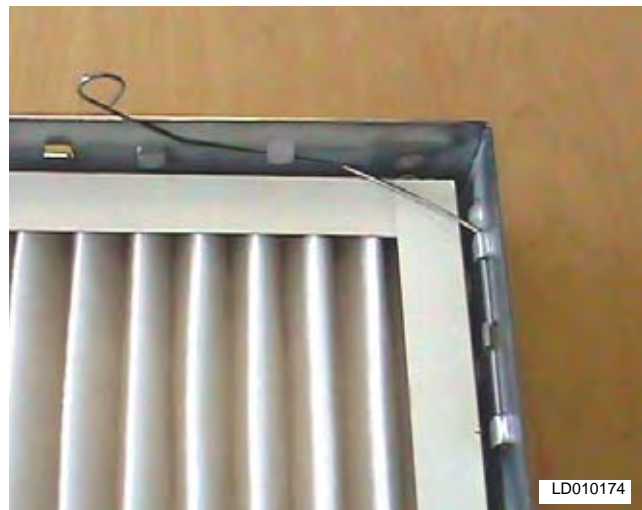


FIG. 2-100 – FULLY INSTALLED FILTER

INSTALLATION OF 4" AMAIR 300X PLEATED FILTER

These instructions are for installing a four (4)" filter (typically AmAir 300X pleated filter) into 16 ga. galvanized holding frames.

- Latches needed for these applications are four (4) P/N 026-35778-007, as shown in Fig. 2-98.
- A single latch should be installed at each of the four (4) corners of the frame.
- The latch fits into the set of knockouts, which consists of two (2) rows of three (3) knockouts. The row of knockouts closest to the gasketing should be used for filters with a 13/16" single header in combination with a nominal 2" prefilter. The second set of knockouts should be used for nominal 4" filters.

Installation of Spring Latches

1. Insert the straight end of the latch between the two (2) knockouts furthest from the corner.
2. Using a moderate amount of pressure, force the latch over the third knockout.
3. The latch installation is now complete. The latch should now be "trapped" within the three (3) knockouts (see Fig.2-101).

Repeat the installation process with the remaining latches.



FIG. 2-101 – CORRECTLY INSTALLED LATCH P/N 026-35778-007

4. Insert the filter into the frame.
5. After the filter has been placed into the frame, grasp the loose end of the latch and place it over the filter frame, so that the latch secures the filter into the frame (see Fig.2-102).

Repeat for the remaining latches.



FIG. 2-102 – PLACE THE END OF THE LATCH OVER THE FILTER FRAME, SECURING THE FILTER TO THE FRAME.

6. The filter should now be securely installed into the frame.

INSTALLATION OF SH SINGLE HEADERED FILTERS

These instructions are for installing single header filter (typically VariCel SH or DriPak 2000 filter) into 16 ga. galvanized holding frames.

- Latches needed for these applications are four (4) P/N 026-35778-000, *as shown in Fig.2-98.*
- A single latch should be installed at each of the four (4) corners of the frame.
- The latch fits into the set of knockouts, which consists of two (2) rows of three (3) knockouts. The row of knockouts closest to the gasketing should be used for nominal 1” filters or filters with a 13/16” single header. The second set of knockouts should be used for nominal 2” filters.

Installation of Latches

1. Insert the straight end of the latch between the two (2) knockouts furthest from the corner.
 2. Using a moderate amount of pressure, force the latch over the third knockout.
 3. The latch installation should now be complete. The latch should now be “trapped” within the three (3) knockouts, but should be able to freely rotate.
- Repeat the installation process with the remaining latches.
4. Rotate all of the latches outward, and insert the SH filter into the frame. The bulk of the filter should be inserted through the frame, protruding out the backside. Only the header of the filter should be contacting the flange of the frame.
 5. After the filter has been placed into the frame, grasp the circular end of the latch and rotate it across the corner of the filter.

Push the end of the latch towards the filter, until the latch catches beneath the knockout on the frame.

Repeat for the remaining latches.

6. The filter should now be securely installed into the frame (*see Fig.2-103*).

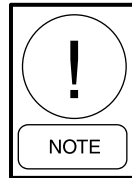


FIG. 2-103 – INSTALLED CARTRIDGE FILTER
2-70

INSTALLATION OF A 2” PREFILTER IN COMBINATION WITH A SINGLE HEADER FINAL FILTER

These instructions are for installing a 2” prefilter, (typically PerfectPleat, Premium or Premium HM pleated filter) used in combination with a single header final filter (typically VariCel SH or DriPak 2000) into 16 ga. galvanized holding frames.

- Latches needed for this application are four (4) P/N 026-35778-000 and four (4) 026-35778-007 *as shown in Fig.2-98.*



Follow instructions for Single Headered (SH) filters then proceed with this procedure for 2” Pre-filters.

Installation of Latches

1. Insert the straight end of the latch (P/N 026-35778-007) between the two (2) knockouts furthest from the corner.



FIG. 2-104 – INSTALL LATCH P//N 026-35778-007

2. Using a moderate amount of pressure, force the latch over the third knockout (*See Fig. 2-104*).
3. After both filters have been placed into the frame, grasp the loose end of the latch and place it over the prefilter frame, so that the latch secures the prefilter to the SH filter. Repeat for the remaining latches.
4. The filters should now be securely installed into the frame, *as shown in Fig.2-105*.



FIG. 2-105 – INSTALLED CARTRIGE W/PLEATS

INSTALLATION OF A VARICEL DH DOUBLE HEADERED FILTER

These instructions are for the installation of a VariCel DH filter (nominal 12" deep double header) into 16 ga. galvanized holding frames.

- The latches needed for this application are four (4) spring latches, P/N 026-35778-006 (as shown in Fig.2-98).
- Two latches should be attached on each side of the filter frame.
- The latches should only be installed, two (2) per side of the frame. There should be no latches used on the top or bottom. This is done to match the holes in the filter frame, used to secure the latch to the filter. See Fig.2-106 for the sets of knockouts that should be used for the latches.

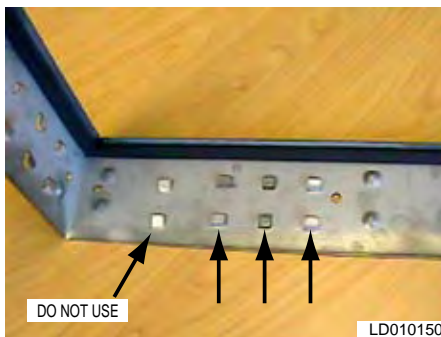


FIG. 2-106 – CORRECT USE OF KNOCKOUTS

Installation of Spring Latches

1. Insert the straight end of the latch between the knockouts furthest from the corner.
2. Using a moderate amount of pressure, force the latch over the third knockout.
3. The latch installation should now be complete. The latch should now be “trapped” within the three (3) knockouts.



FIG. 2-107 – CORRECT LATCH/KNOCKOUT CONFIGURATION.

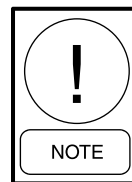
JOHNSON CONTROLS

4. Repeat the latch installation with the remaining latches. Note the orientation of the latch to the knockouts in Fig.2-107.

After the latches have been installed, the frame should be configured like that shown in Fig.2-108.



FIG. 2-108 – FRAME WITH 4 LATCHES INSTALLED.



The frame contains 2 latches per side, none on the top or bottom.

5. Insert the VariCel DH filter into the frame. While holding the filter in the frame, grasp the loop on the end of the latch and pull it until it stretches over the header and rests into the pre-drilled hole in the header of the filter (see Fig.2-109). Repeat this with the remaining latches.
6. The filter should now be securely installed into the frame.



FIG. 2-109 – SPRING LATCH SHOULD BE PULLED AND FASTENED IN HOLE IN THE HEADER OF THE FILTER.

INSTALLATION OF A 2" & 4" PREFILTER IN COMBINATION WITH A DOUBLE HEADER FINAL FILTER

These instructions are for installing either a 2" or 4" prefilter (typically PerfectPleat, Premium or Premium HM pleated filters) used in combination with a VariCel DH (nominal 12" deep) final filter into 16 ga. galvanized holding frames.

- Two sets of latches are needed for these applications. Four (4) spring latches, P/N 026-35778-006 are used to hold the VariCel DH into the frame. In addition, four (4) prefilter latches, P/N 026-36339-001 are used to hold the 2" and P/N 026-36339-000 are used to hold the 4" prefilter onto the face of the VariCel DH filter.
- For the spring latches, two (2) latches should be attached on each side of the filter frame.
- The latches should only be installed, two (2) per side of the frame. There should be no latches used on the top or bottom. This is done to match the holes in the filter frame, used to secure the latch to the filter.

Installation of Spring Latches

1. Insert the straight end of the latch between the knockouts furthest from the corner.
2. Using a moderate amount of pressure, force the latch over the third knockout.
3. The latch installation should now be complete. The latch should now be "trapped" within the 3 knockouts (see Fig.2-110).



FIG. 2-110 – CORRECT LATCH/KNOCKOUT CONFIGURATION. P/N 026-35778-006

4. Repeat the latch installation with the remaining latches; *note the orientation of the latch to the knockouts on Fig.2-110.*
5. Insert the VariCel DH filter into the frame. While holding the filter in the frame, grasp the loop on the end of the latch and pull it until it stretches over the header and rests into the pre-drilled hole in the header of the filter (see Fig.2-111). Repeat this with the remaining latches.

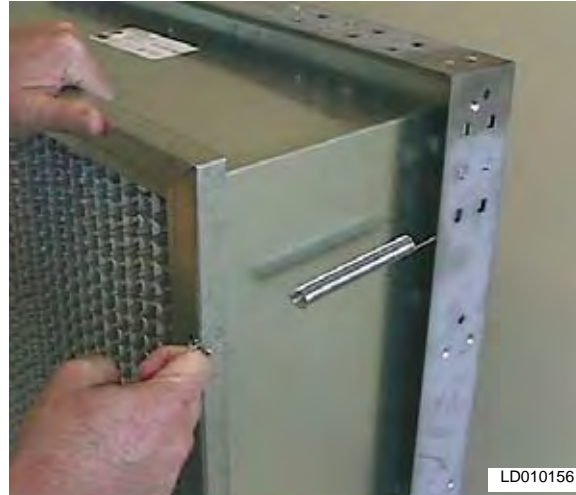


FIG. 2-111 – FRAME WITH 4 LATCHES INSTALLED

Installation of Prefilter Latches

6. To install the prefilter latches, slide the end of the latch with the 180 ° turn, over the edge of the header, as shown in Fig.2-112. The latch should be installed at the approximate midpoint of the filter leg.

The prefilter latch should be slid over the header as shown in Fig.2-112.

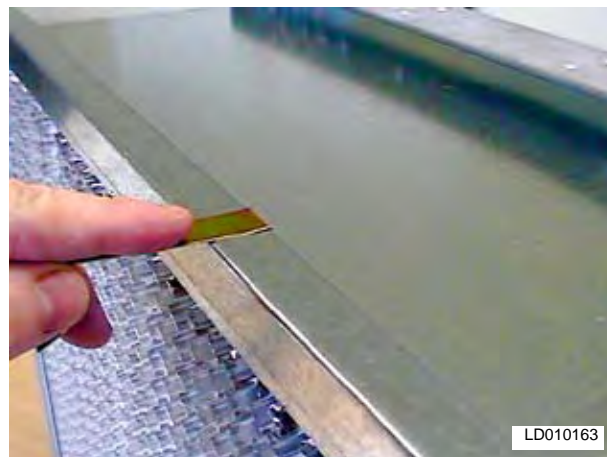


FIG. 2-112 – PREFILTER LATCH AFTER INSTALLATION ONTO FILTER HEADER.

7. Repeat the installation for the remaining prefilter latches.
8. Place the prefilter against the face of the VariCel DH filter. The prefilter latches may have to be re-positioned *as shown in Fig.2-113*, to allow the proper placement of the prefilter.



FIG. 2-113 – POSITION PREFILTER IN FRONT OF THE FINAL FILTER. (2" W/026-36339-000 LATCH SHOWN)

9. Grasp the end of the prefilter latch and “spring” it so that it fits over the edge of the prefilter. Repeat with the remaining latches.

After all remaining prefilter latches have been placed around the prefilter; the finished assembly should look *like that in Fig.2-115*.



FIG. 2-114 – SPRING THE END OF THE LATCH SO THAT IT FITS OVER THE EDGE OF THE PREFILTER. (4" W/026-36339-000 LATCH SHOWN)

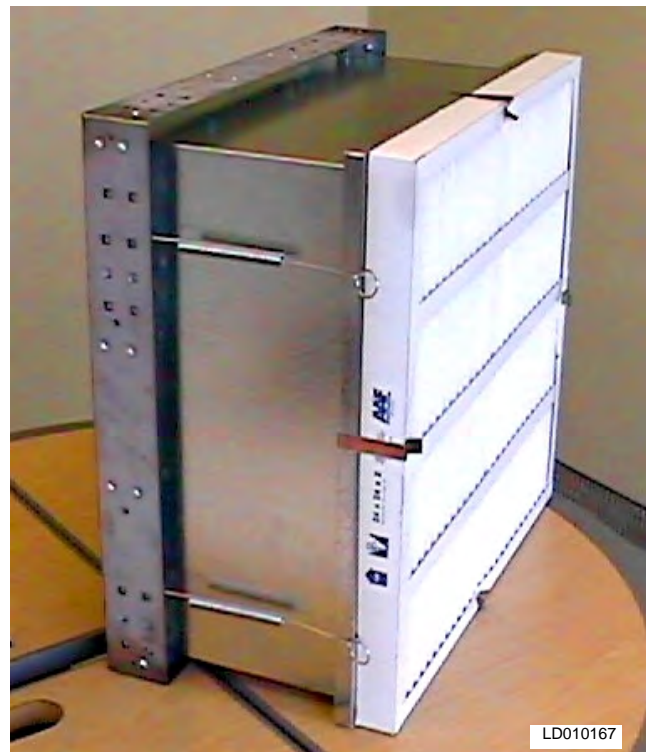


FIG. 2-115 – COMPLETED ASSEMBLY

| VISUAL CONTROL FILTER CLAMPS FOR HEPA FILTERS | | |
|---|--------------------|------------|
| Part Number | Latch Model Number | Length (L) |
| 029-22081-000 | Latch, HEPA Single | 11-1/2" |
| Application: Holds one Astrocel I 11.5" D filter along frame sides. (See Fig. 2-117, 2-118 & 2-119 for application) | | |
| 029-22082 | Latch, HEPA Double | 11-1/2" |
| Application: Holds one Astrocel I 11.5" D filter along frame middle. (See Fig. 2-117, 2-118 & 2-119 for application) | | |

HEPA FILTERS

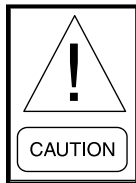
WELDED BEVEL SEAL FRAME

Extruded Aluminum Frames for Gasketed HEPA Filter Installations

The Bevel Seal frame is a factory welded, extruded aluminum frame developed specifically for High Efficiency Particulate Air (HEPA) filter installations. Standard Bevel Seal frames accommodate multiple sizes of gasketed HEPA filters 11-1/2" deep. (See Fig. 2-116, 2-118 & 2-119.)

Two Stage Gasket Compression Prevents Leakage

The Bevel Seal frame features a two level sealing surface connected by a bevel. This causes the filter gasket to be compressed in two stages as clamping pressure is applied. The outer edge of the gasket is compressed to a greater degree than the inner portion of the gasket. (See Fig. 2-119.)



In the event excessive clamping pressure is applied, the individual cells in the gasket material can be fractured causing the gasket to relax, allowing leakage.

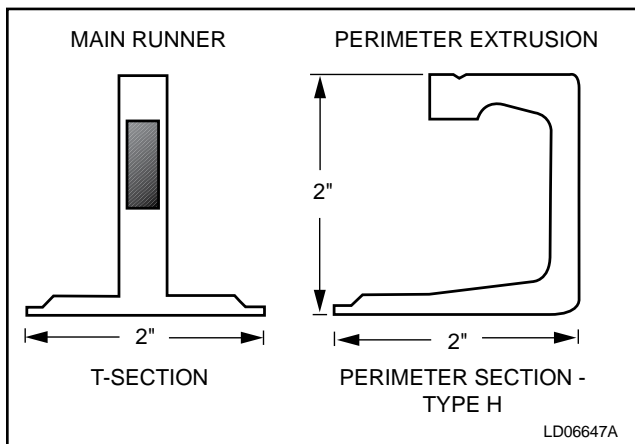


FIG. 2-116 – HEPA FILTER FRAME CROSS SECTION VIEW

VISUAL CONTROL FILTER CLAMPS

(See Fig. 2-117.)

HEPA Filter Applications

Visual Control clamps are designed for use with any conventional gasketed HEPA filter. Located at midpoint of each filter edge, the calibrated spring-loaded clamps maintain up to 100 pounds pressure against the filter at each clamping point. Four clamps are used per filter to assure uniform pressure against the gasket. The clamps have a 1-1/2" wide bearing surface.

Easy Clamp Installation

No special tools are required for proper clamp installation. ***Just tighten the bolt head until it is flush with the clamp face*** to achieve the prescribed compression. Proper clamping pressure is created indefinitely by the calibrated spring.

Single filter clamps are used around the perimeter of the frame bank. Double clamps are used along main runners to secure a filter on either side of the T-section. (See Fig. 2-117, 2-118 & 2-119.)

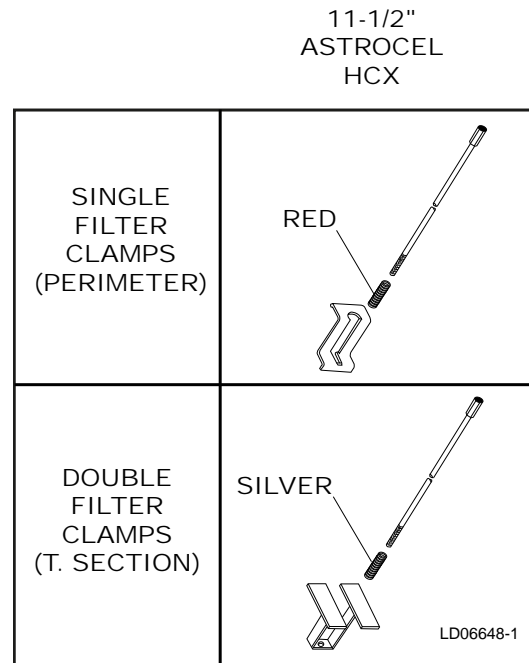
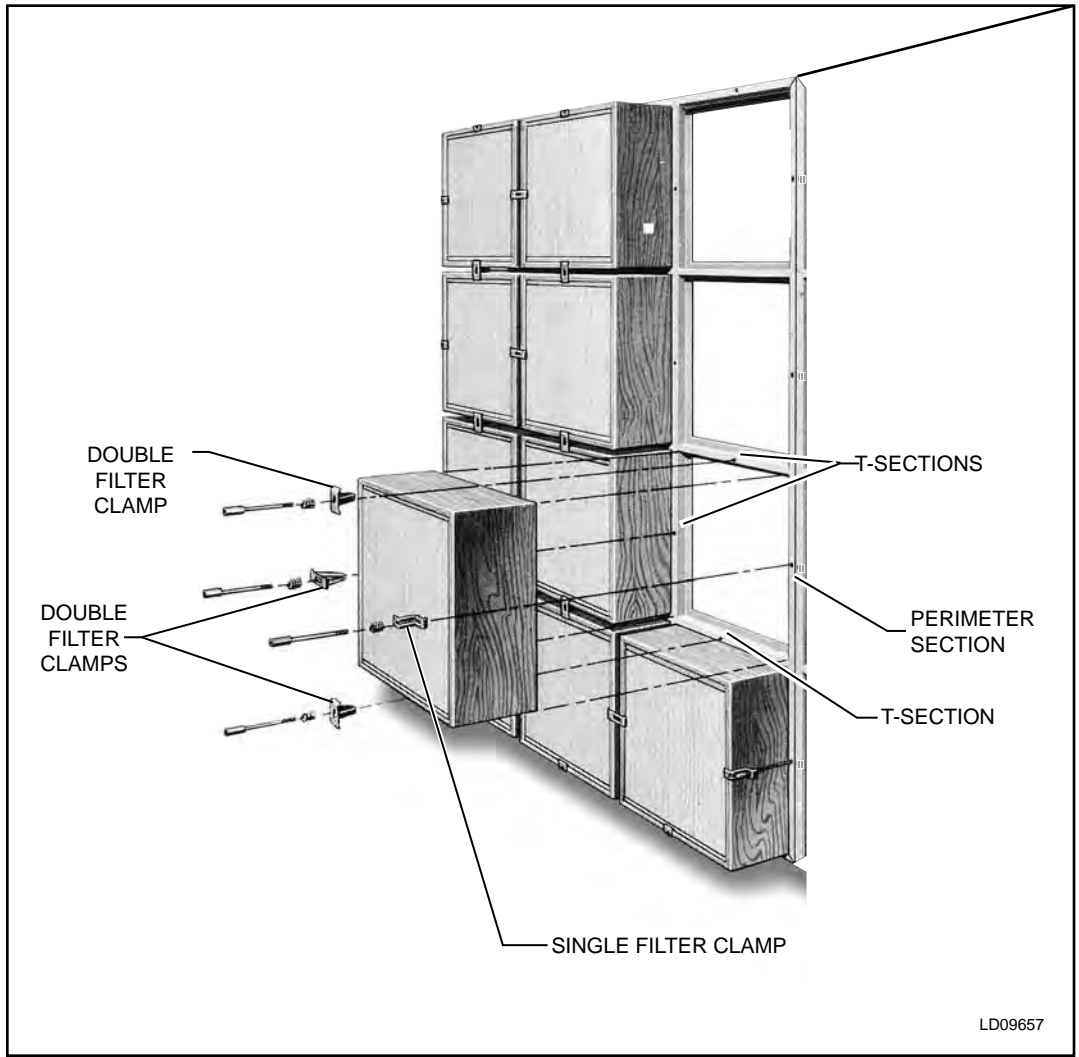
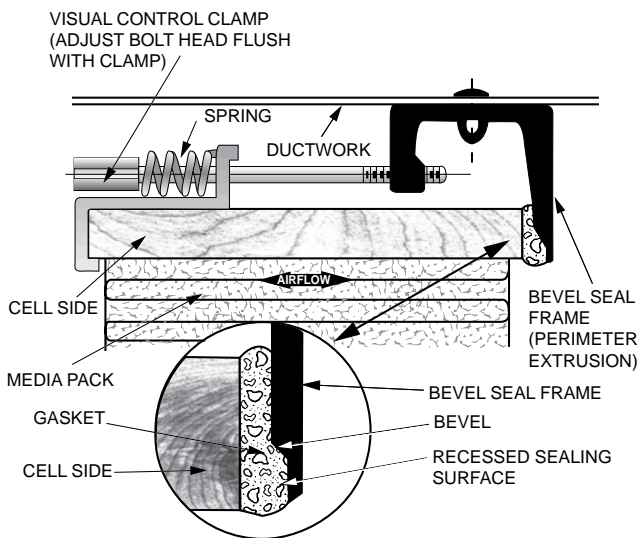


FIG. 2-117 – VISUAL CONTROL FILTER CLAMPS



LD09657

FIG. 2-118 – HEPA FILTER INSTALLATION



LD06646A

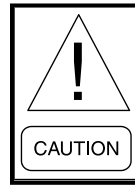
FIG. 2-119 – WELDED BEVEL SEAL FILTER INSTALLATION

THIS PAGE INTENTIONALLY LEFT BLANK

3.0 STARTUP



Rotating parts and electrical shock hazards exist. Lock out and tag out the fan motor(s) and heat power disconnects before servicing. FOLLOW THE LATEST "LOCKOUT TAGOUT" PROCEDURE. Failure to follow proper safety precautions may result in serious injury or death. Refer to general safety guidelines and safety symbols located at the front of this Manual. ►

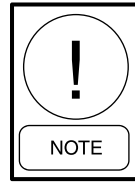


While it is a common practice to operate the fan as soon as possible (air movement during construction is always preferred by contractors) on the job site, the incomplete ductwork and missing diffuser grilles will greatly reduce air resistance and will allow the fan to operate beyond design parameters. This practice may result in water carry over and flooding of the unit. Also, the motor may over Amp and become damaged.

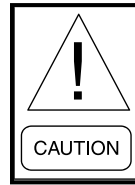


Always replace metal tab on access doors that provide access to moving parts. This mechanical protection from moving parts is required by UL-1995.

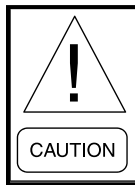
When internal safety catch is not used, always replace metal tab on access doors that provide access to pressurized areas. This mechanical protection is to prevent accidental release of access doors under positive pressure.



Fan manufacturer's describe the rotation of the fan impeller as being "clockwise" or "counterclockwise" for centrifugal fans when viewing the drive side (see AMCA Standard 2406).

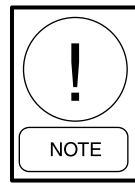


If your unit has HEPA filters the filter frames, filter bulkheads and filter segment panels are factory sealed and must remain sealed for NO air bypass.



Serious damage to the AHU and/or system is eminent if the AHU is operated under any of the following conditions:

- *Without proper control of dampers.*
- *With smoke dampers closed.*
- *During a fire alarm or smoke purge test.*
- *Any airflow restriction greater than normal.*
- *Fluctuating or incorrect voltage power supply*



Never use silicone caulk/sealant or caulk/sealant containing silicone in or on any air handling equipment. [Only exception is when provided (high temperature) with gas heat venting].

PRE START-UP

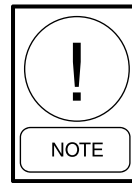
Refer to air handler start-up checklist, Form 100.00. CLI provided with information package shipped with unit. ► Perform a general inspection. Identify and perform appropriate “lock out/tag out” and safety rules. For details on points below, see appropriate section of this Installation Instruction and IOM 102.20-NOM1. For VFD equipped air handlers, refer to the VFD literature for additional start-up requirements.

- Verify equipment received as ordered.
- Check for damage to the interior and exterior of unit.
- Verify unit installed on flat and level surface.
- Ensure terminal screws and wiring connections secure in control, electric and Air Modulator panels.
- Verify air hoods field installed properly.
- Verify condensate drain properly trapped.
- Verify all wiring and tubing connections complete at shipping splits.
- Verify all field-piping connections complete.
- Verify all shipped loose parts installed.
- Verify all ductwork is complete and available for full airflow.
- Verify unit installed with proper clearances.



- **Verify installer has removed all dirt, debris, hardware, mold, etc. from interior of air handler and ducts.**

- Visually inspect roof curb for tight seal around unit.
- Ensure clean air filters installed properly and secured (see IOM Section 4).
- Verify filter gauge set to zero.
- Inspect all field provided wiring for completeness.
- Verify all shipping splits sealed and secured properly.
- Verify pipe chase floor sealed at penetrations.
- Verify all shipping bolts and other materials have been removed.



Do not remove functional bolts from seismic isolators (see Fig. 3-6).

- Ensure damper linkage is tight and in correct “power off” position.



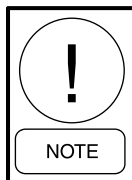
Return air dampers may be closed for shipping. Loosen actuator or crank arm on jackshaft, open dampers, and retighten actuator or crank arm.

- Verify controls installation complete.
 - Contractor Furnished Controls - Controls contractor is responsible for safe and proper control of air handler.
 - Factory Furnished Controls - See *Factory Engineered Controls/Factory Packaged Controls (FEC/FPC)*.
- The termination chart is attached to the inside of control enclosure door (see Fig. 3-1).



FIG. 3-1 – TERMINATION CHART INSIDE ENCLOSURE DOOR

PRE START UP FAN ASSEMBLY INSPECTION



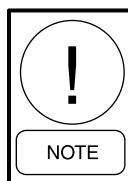
When the unit is removed from long-term storage moisture laden bearing grease should be purged and replenished with fresh grease per lubrication decal. The motor should be meggered to verify that the resistance is still at a satisfactory level compared to the value recorded prior to storage.

- Check the bearings and locking collars (refer to Table 3-1, “Torque for Tightening Setscrews”).

| SETSCREW DIA. | HEX. SIZE ACROSS FLATS | MIN. RECOMMENDED TORQUE | |
|---------------|------------------------|-------------------------|--------------|
| | | INCH LBS. | FOOT LBS. |
| 1/4 | 1/8 | 66 - 85 | 5.5 - 7.08 |
| 5/16 | 5/32 | 126 - 164 | 10.5 - 13.7 |
| 3/8 | 3/16 | 228 - 296 | 19.0 - 24.7 |
| 7/16 | 7/32 | 348 - 452 | 29.0 - 35.7 |
| 1/2 | 1/4 | 504 - 655 | 42.0 - 54.6 |
| 5/8 | 5/16 | 1104 - 1435 | 92.0 - 119.6 |

- Verify fan wheel properly aligned, tight on shaft and freely moving.
- Ensure fan bearings properly lubricated (see Fan label or IOM Section 4, “Fan Bearing Lubrication”). ▶
- Belts and Sheaves
 1. Verify sheaves properly aligned and tight on shaft. Improper sheave alignment and belt tension are potential causes of excessive noise and vibration, as well as shortened belt and bearing life (see IOM Section 4, “Sheaves Alignment”). ▶
 2. Check belt tension. If not familiar with the process (see IOM Section 4, “Belts” and “Adjustable Motor Base Operation”). ▶

It is normal for belts to loosen after start up. The new belts will “run in” or “take a set” by seating slightly deeper into the grooves of the sheaves. Recheck tension after one day and three days.
 3. Ensure motor mounting bolts and adjustable motor base bolts are tight.
- Verify tie down bolts removed from 4 corners of fan base assembly.



In small units the tie down bolts may only be applied to three corners of the fan base since one corner is not accessible.

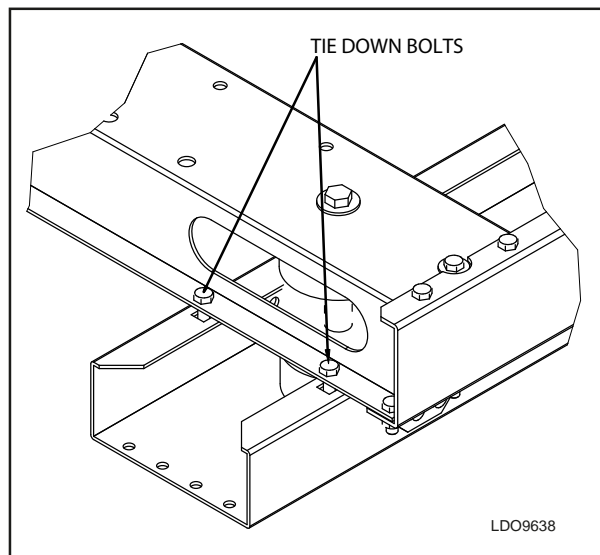


FIG. 3-2 – FAN AND MOTOR ISOLATOR SUPPORT FRAME.

3

MOTORS - ODP VS. TEFC

See Fig. 3-3 for ODP.



FIG. 3-3 – ODP (OPEN DRIP PROOF)

See Fig. 3-4 for TEFC.



FIG. 3-4 – TEFC (TOTALLY ENCLOSED FAN COOLED)

- Fig. 3-6 shows isolator with seismic snubber restraint option.

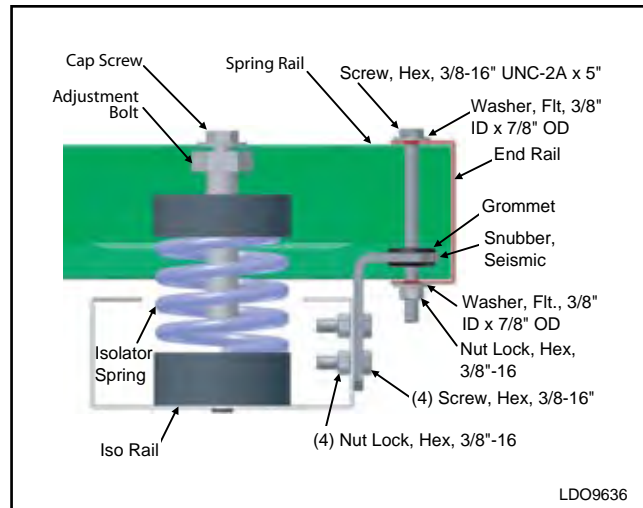


FIG. 3-6 – SEISMIC SNUBBER

ISOLATORS

Check fan base isolators and thrust restraints for proper adjustment.

- Standard fan isolation consists of spring isolators (see Fig. 3-5) mounted under the internal fan assembly.

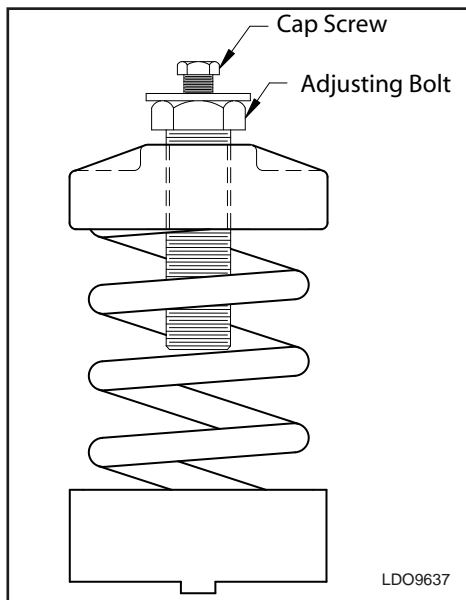


FIG. 3-5 – SPRING ISOLATOR

Preparing Fan Isolators for operation:

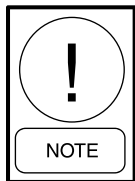
1. After tie down bolts are removed from the internal fan assembly check blower/motor frame for correct height and that the frame is level.
2. To adjust isolators (see Fig. 3-5): First loosen cap screws on top of adjustment bolt. Then turn adjusting bolt. Next, check operational height and level of frame. Repeat this procedure until operational height and frame is level. Finally, tighten cap screws. (See IOM Section 5, "Isolator Adjustment" for additional instructions). ►
3. Verify the fan is aligned with unit discharge.
4. Re-adjust as necessary with isolators.

- For thrust restraint adjustment procedures, when applied, (see IOM Section 5.0). ►

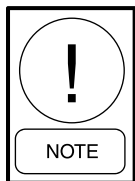
START-UP



Temporary Operation: *This equipment should not be operated until after complete Start-up as outlined in this guide. Do not allow the unit to run on temporary power that is not reliable and could be off/on periodically or rapidly. Also, protect it from irregular voltages and surges.*



We strongly recommend the startup technician use the checklist provided and record the gathered information in the appropriate fields. If there are any specific questions refer to the document list on the checklist. Also, at the end of Section 3 is located a list of references for various check points on the checklist (*Inspection Requirements*). This is a guide to "How To" information in this and other documents.



Filter media must be installed prior to Start-up. *Use media provided or temporary media that will adequately protect the components in the air stream and duct system.*

CHECK OPERATION OF FANS

1. Energize power to the unit disconnect switch.
2. Verify correct voltage, phase and cycles.
3. Energize fan motor(s), briefly (bump) and check for correct fan rotation.

If rotation is incorrect:

1. On three-phase equipment reverse any 2 motor leads at the load side of last starter component.
2. On single-phase equipment, follow wiring diagram on motor housing or inside motor terminal box.
3. Re-check for correct fan rotation.

CHECK OPERATION OF DAMPERS

Ensure unit will not operate with all dampers closed.

Linkage design and/or damper linkage may not be provided by YORK. Airflow control dampers may be operated with pneumatic or electric actuator/controllers.



Prior to occupancy, test ventilation system to ensure that outdoor air dampers operate properly in accordance with the system design.

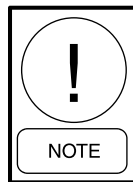
AIRFLOW CONTROL DAMPERS

Many combinations of damper sizes are available to control the flow, the mixing of return air and outside air in the air inlet section of the unit may be supplied as follows:

- One hundred percent outside air, 100% return air.
- One hundred percent outside air, 0% return air.
- Zero percent outside air, 100% return air.
- Economizer Section - 100% outside air, 100% return air, 100% exhaust air or mixed air.



On dampers with actuators, interconnecting damper linkage is only provided when selected by Sales.



Dampers, actuators, controls and linkage must be checked prior to applying power to the operators making sure nothing will obstruct the operation of the dampers. Do not overdrive damper actuators as this may cause damage to the dampers.



Return air dampers may be closed for shipping. Loosen actuator or crank arm on jackshaft, open dampers, and retighten actuator or crank arm. Field is responsible for adjustments.

TYPICAL ACTUATORS LOCATIONS

Johnson Controls standard actuators are direct coupled on damper jackshaft.

BASIC ACTUATORS INSTALLATION

A basic procedure for installing Johnson Controls actuators is included in Section 2 "Installation".

DAMPER BLADE ORIENTATION

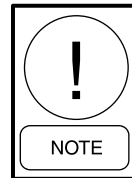
Return Air and Mixing Dampers with Power Off

Position the blades so that they will be open once the actuator is installed. This will be the dampers spring return position. Note whether the damper shaft is rotated fully clockwise or counter clockwise.

Outside Air and Exhaust Air Dampers

Position the damper blades so that they will be closed with power off. This will be the dampers spring return position. Note whether the damper shaft is rotated fully clockwise or counter clockwise.

With the actuator shaft clamp tightened to the damper jackshaft, and the damper shaft is completely rotated to its proper position, manually operate the actuator to its fully actuated position using the crank arm provided with the actuator. Then release the spring to allow the damper to go back to its original position. This will verify the actuators spring rotation and stroke. Set the damper actuators rotation selector switch to the proper rotation required to actuate the damper.



Damper actuator will always be opposite the spring return rotation.

ENERGIZE FAN MOTOR(S)

1. Observe fan(s) for smooth operation.
2. Check motor nameplate Full Load Amp rating.
3. Immediately, check current draw of each leg of each motor.

VARIABLE SPEED DRIVE (VSD)

YORK Air-Modulator (Variable Frequency Drive)



YORK Air Modulators are provided with Start-up service. See Installation and Start-up Guide provided with the YORK Air Modulator.

SWEEP BALANCE RESULTS:

The values listed below exceed the peak to peak tolerance through the sweep balance. When programming the Variable Speed Drive, lock-out or skip these frequency ranges during fan start up and shut down. If the peak is marked as N/A, it was within tolerance and does not need to be locked out or skipped.

Lock-out (Skip) Freq. Range(s)

| | |
|---------|-------------------|
| PEAK #1 | 975-1025 (RPM) |
| | 27.9-29.3 (Hertz) |
| PEAK #2 | 1348-1407 (RPM) |
| | 38.5-40.2 (Hertz) |
| PEAK #3 | (RPM) |
| | (Hertz) |

FIG. 3-7 – EXAMPLE OF SWEEP BALANCE RESULTS

SET UP OF A NON- FACTORY MOUNTED VFD

Refer to manufacturer's Start Up Guide

The Variable Frequency Drive (VFD) that controls the speed of a YORK Solution air handler fan needs to be set up so the fan does not run at resonant frequencies. Improper adjustment may damage the equipment. To determine which speeds are detrimental to the YORK equipment, refer to the document (058-008-002) supplied with the YORK Solution air handler. This information can also be found on the label located on the blower housing (see Fig. 3-7). This document lists any frequencies and the bandwidths that need to be jumped (skipped) by the VFD. The installer needs to program the jump (skip) frequencies and the bandwidths referenced in document (058-008-002) into the VFD. Failure to properly set the VFD before applying power to the motor will void the fan and motor warranty.



If the skip frequencies are not available to the installing contractor, the contractor must have the fan analyzed by a professional balancer before the VFD can be set and power is supplied to the fan.

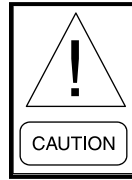
CHECK DOORS AND LATCHES FOR PROPER ADJUSTMENT

See IOM Section 5 "Door Handle/Latch Replacement and Adjustment". ►



Plastic spacers must be removed between doors and doorframes before Start-up.

SHEAVES



If optional adjustable sheaves provided, we strongly recommend they be replaced with correctly sized fixed sheave immediately after system air balance is performed. It is not unusual for an adjustable sheave at some point in time to create damaging vibration in the fan assembly.

General Guidelines for replacing an adjustable sheave with a fixed sheave:

Measure the outside diameter of a belt while it is seated into at least one half the circumference of an adjustable sheave groove. Use this measurement as the sheave "pitch diameter". Order a sheave or sheave and bushing combination that matches pitch diameter, belt cross section and bore size. Order a sheave of good quality and require that it is pre- balanced.

Reference Airside Parts - phone (800) 545-7814 to purchase new sheaves.

Provide the following information:

- Drive tag information (see Fig 3-8).
- New fan RPM
- Measurement of pitch diameter adjustable sheave is set at.
- Job ID # from YORK Solution Unit ID Label.

A new driver (motor) sheave or sheave and bushing are usually all that is required to directly replace the present adjustable driver sheave.



FIG. 3-8 – TYPICAL DRIVE KIT DATA TAG

ENERGY RECOVERY WHEEL

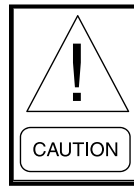
UNIT CONFIGURATION

- Indoor Units

All indoor units will accommodate vertical Energy Recovery Wheel segments on horizontal (see Fig. 3-9).

- Outdoor Units

All outdoor units will accommodate horizontal Energy Recovery Wheel segments in a low-profile, single unit arrangement (see Fig. 3-10).



**Keep hands away from rotating wheel!
Contact with rotating wheel can cause physical injury.**

START-UP PROCEDURE FOR ENERGY RECOVERY WHEEL

1. With power off, by hand, turn wheel clockwise (as viewed from the pulley side), to verify wheel turns freely through 360° rotation (see Fig. 3-11).

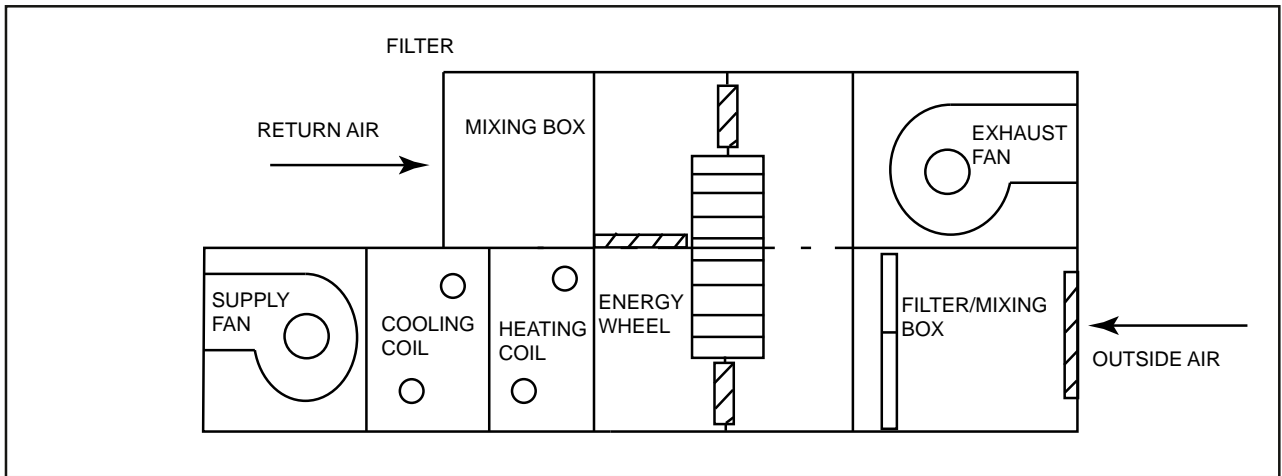


FIG. 3-9 – INDOOR UNIT - VERTICAL WHEEL

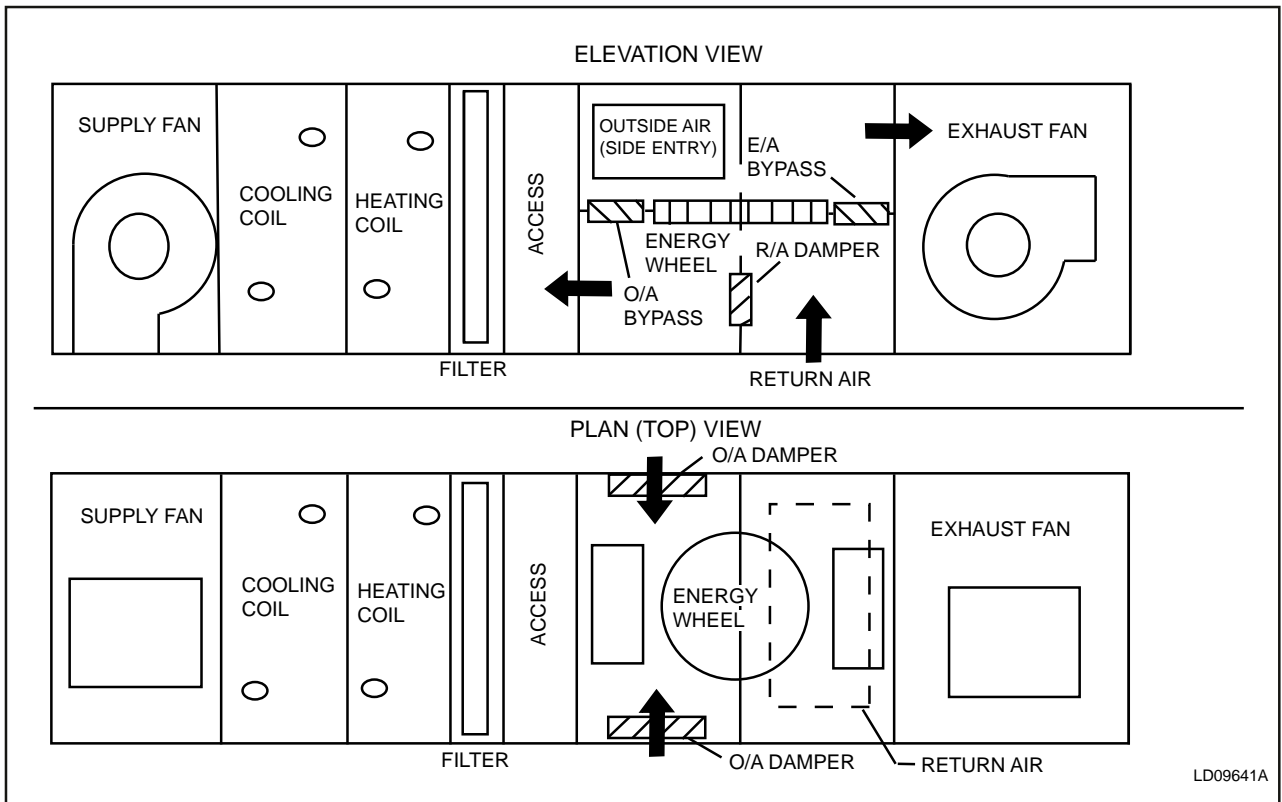


FIG. 3-10 – OUTDOOR UNIT - HORIZONTAL WHEEL

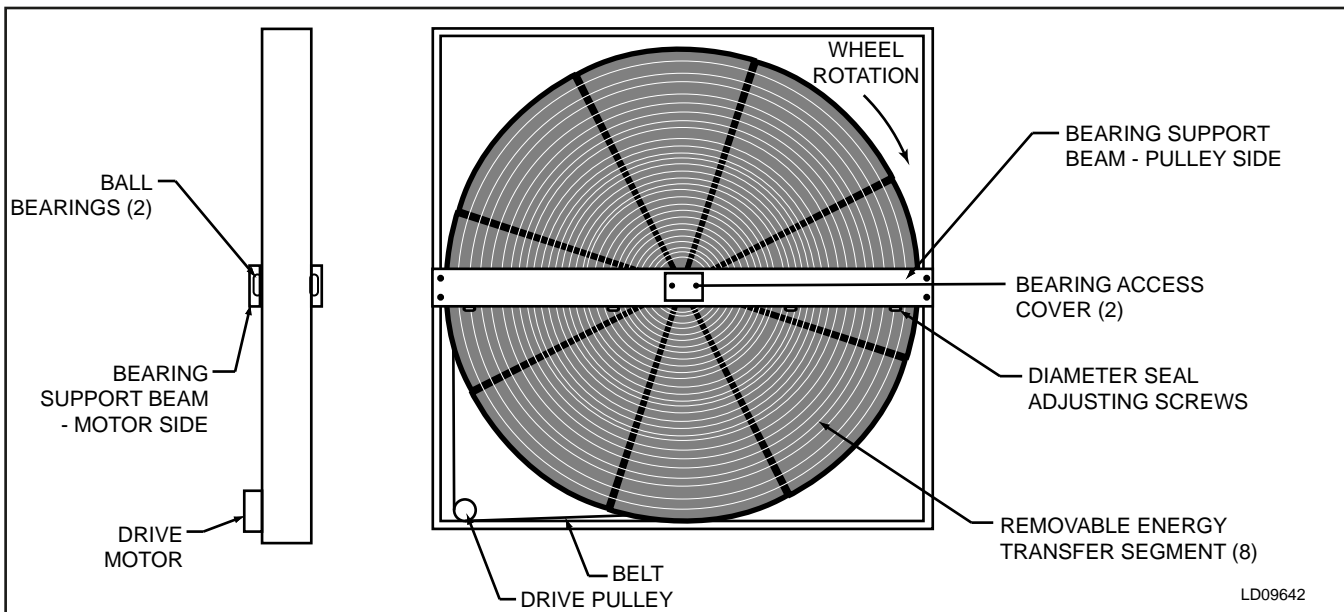


FIG. 3-11 – ENERGY RECOVERY WHEEL - PULLEY SIDE

2. Before applying power to drive motor, confirm wheel segments are fully engaged in wheel frame and segment retainers are completely fastened (see Fig. 3-12).
3. With hands and objects away from moving parts, activate unit and confirm wheel rotation. Wheel rotates clockwise (as viewed from the pulley side).
4. If wheel has difficulty starting, turn power off and inspect for excessive interference between the wheel surface and each of the four (4) diameter seals. To correct, loosen diameter seal adjusting screws and back adjustable diameter seals away from surface of wheel. Apply power to confirm wheel is free to rotate, then re-adjust and tighten hub and diameter seals (see Fig. 3-13).

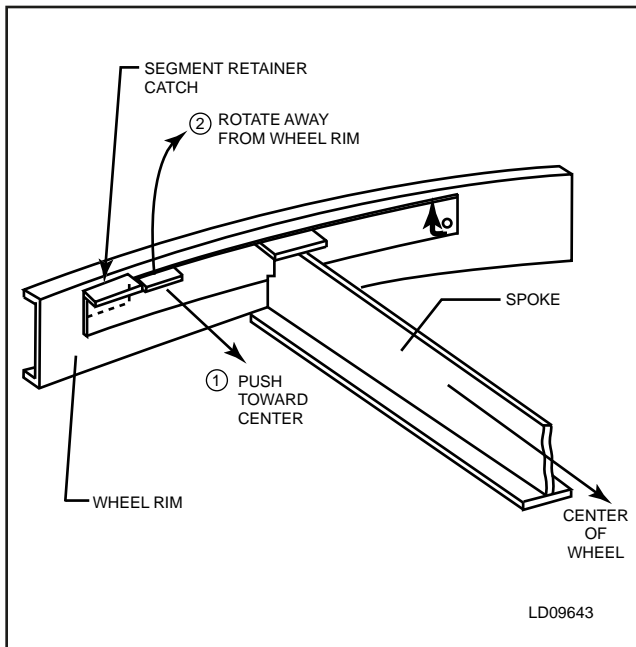


FIG. 3-12 – SEGMENT RETAINER

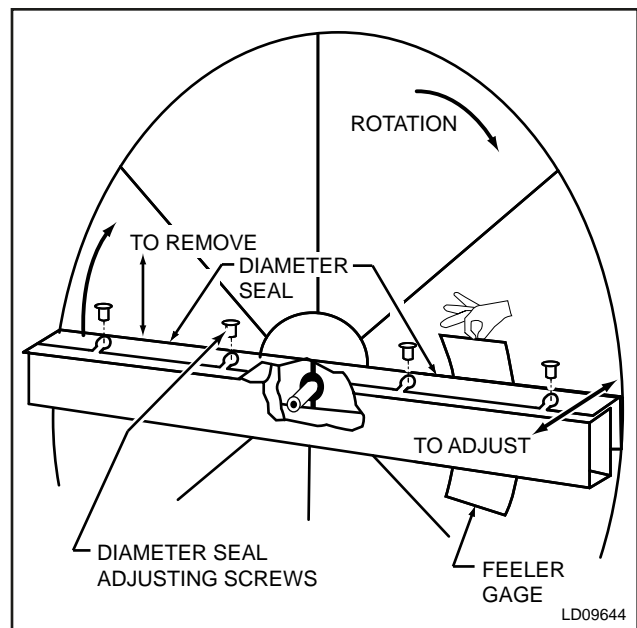
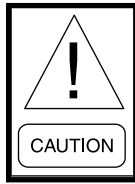


FIG. 3-13 – DIAMETER SEAL ADJUSTMENT

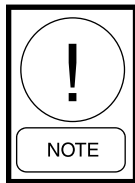
INDIRECT FIRED GAS HEAT START UP - ECLIPSE GAS BURNER START UP 10:1 - 25:1 TURNDOWN & POWERFLAME GAS BURNER START UP 3:1 - 10:1 TURNDOWN



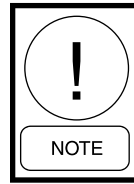
For your safety and satisfaction, this product requires check, test and start-up adjustment by a qualified HVAC technician. Do not use for temporary heat prior to start-up.



Review burner control literature, including wiring, piping, cut sheets and drawings before attempting to start this unit.



All factory test start up burner specifications are located on a laminated "Factory Specification Sheet" located on the inside of the control panel door".



Your gas burner has been carefully inspected and tested at the factory; however, different conditions at the jobsite, including controls that have been added at time of installation, require careful testing and final adjustment for satisfactory operation. The Burner Test Report / Factory Specification Sheet in each unit shows the general data recorded during the operation and safety tests at the factory. This data should be used as a general guide; with final data recorded on the start-up form. Do not exceed 550°F flue temperature at the ID fan inlet. Do not exceed 200°F supply air temperature.

INTRODUCTION

This guideline describes the basic steps a technician would take in starting an Indirect Fired gas heat system on a YORK Solution Air Handler for the first time.

Each gas burner has been test run and inspected at the factory. Adjustments to component settings are typically not required. However, measurements of system parameters should be taken and compared to the measurements recorded on the "Burner Test Report" to ensure safe and reliable operation. The "Burner Test Report" is laminated to the inside of the burner control door.

IDENTIFY THE UNIT TYPE

Two types of Indirect Fired gas burners are used on YORK Solution Air Handlers: The Powerflame series and the Eclipse series. The Powerflame series offers a turndown (modulating ratio) of 3:1 or 10:1. The Powerflame is easily identifiable by the motorized gas valve with external linkage connecting the air dampers on the burner air inlet.

The Eclipse series uses an air/gas ratio regulator with no external linkage, and has a turndown range of 10:1 to 25:1 (sometimes greater). A visible external plastic tube is used to transmit gas pressure from the burner to the regulator. No external linkage is used.

Both burners utilize a combustion air blower. YORK Solution Air Handlers also use an exhaust blower, called an induced draft (ID) blower. This exhaust blower keeps the combustion chamber at a slight negative pressure. Verification of this negative pressure and other system parameters is part of a proper start up procedure.

PRELIMINARY COORDINATION

Contact contractor/customer who requested start-up.

- Verify air handler has had proper start-up.
- Ensure air handler and system is capable of design airflow for gas heat start-up.
- Ensure reliable power is available.
- Verify gas lines are purged of air to equipment valve.
- Verify controls are complete.
- Verify flue (stack) is correctly installed if parts were shipped loose (*see Fig's 3-22 and 3-23*).

TOOLS RECOMMENDED

- **Electrical Multimeter w/ Amprobe**
- **Heating Unit Installation and Operation Instruction.** - One is provided with every heating unit for technical information and troubleshooting.
- **Magnehelic Gauge 0" To .25" WC, Dwyer Series 2000 or Model 1227 Dual Range Manometer.** - For checking pressure over fire (draft).
- **Control Signal Generator, 0 to 20 mA (Altek-234 or 334A)** - For 2 to 10 VDC signal add 500 ohms in series with signal generator.
- **Magnehelic Gauge 0" to 15" WC and 0 to 3 lbs. (Dwyer series-2000) or Monometer (Dwyer- 1227) Dual Range Monometer.** - For checking supply gas pressure and manifold gas pressure or pilot gas pressure.
- **Honeywell - S7800A Test Module** - For use on (Honeywell-7800) Series Relay Module. (Available through Airside Parts - 800-545-7814, Ext.12).
- **Flue Gas Analyzer (CO₂ and O₂)**
- **Stack Thermometer (0°F - 1000°F approx.)**
- **Digital Manometer (replaces Magnehelic Gauge).**
 - Digital Manometer
 - Cat. #475-1 FM-AV
 - Series: 475-1 Mark III
 - Range: 0 to 19.99 In. W.C.
 - Dwyer Instruments, Inc.

AIR HANDLER PRE START CHECKS

- Verify air handler has had proper start up and airflow is at design maximum for heating cycle (*refer to air balance report*).
- Set bypass damper if provided in air handler.
- Airflow proving switch for main supply fan installed and operational.
- Check with Control Technician: two-minute post-purge programmed in air handler controller. Upon call for air handler unit stop, burner cycles off then air handler fan cycles off two minutes later.

BURNER PRE START CHECKS

1. Open fuse disconnects before working on burner (*see Fig. 3-14*).

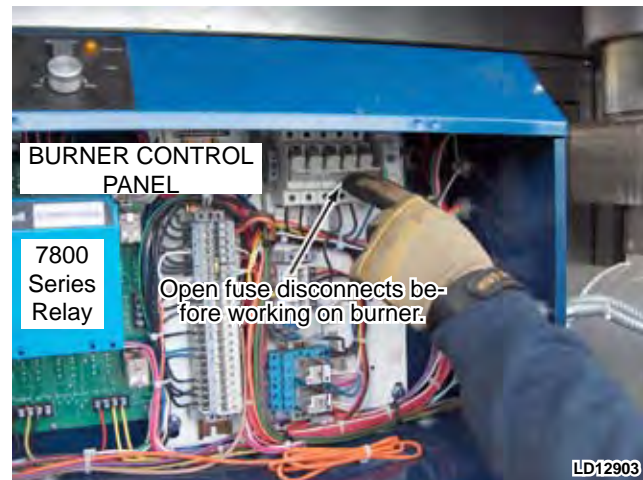


FIG. 3-14 – OPEN FUSE DISCONNECTS

2. Check all wire terminations for tightness.
3. Check that the incoming voltage(s) are correct. Compare measured voltages to burner motor and ID motor nameplates and the "Burner Test Report". Reset fuse disconnects.
4. Check for correct rotation of 3 phase burner motor and ID motor.
5. Verify that contractor has purged new gas lines of air up to manual valve on gas train.
6. Valves which have been closed for shipping must be opened accordingly. Check that all manual valves operate without leaks.

7. The flue (stack) damper is located at the discharge of the ID blower and closed for shipping. Release the locking mechanism and set the damper to match the position indicated by the scribed markings. Lock in place (see Fig. 3-15).

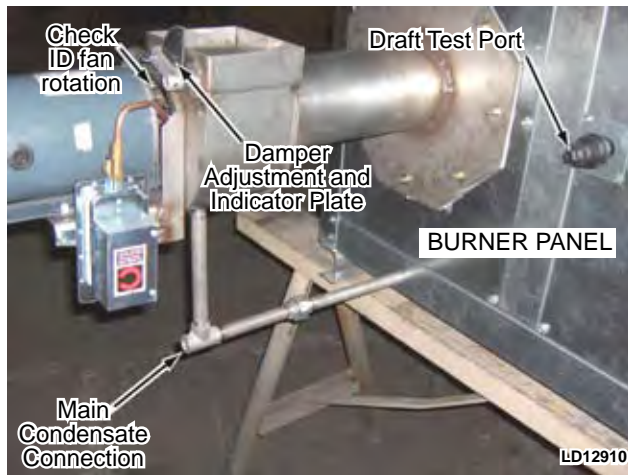


FIG. 3-15 – SET ID FAN DAMPER

8. Inspect condensate drain trap to see that it is large enough, as described in this guideline (see Fig. 3-21).
9. Measure the gas supply pressure coming into the gas train (see Fig. 3-16). Gas pressure can be greater than shown on the “Burner Test Report”, but it must be between the min/max values listed in Table 3-2.

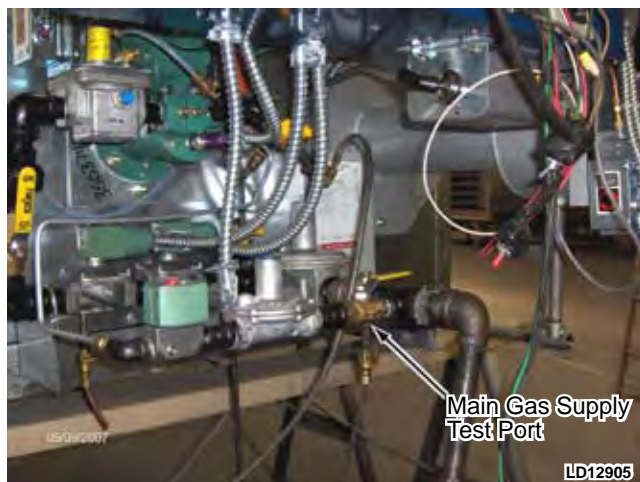
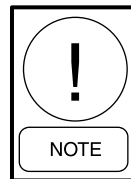
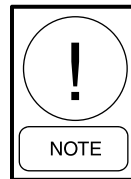


FIG. 3-16 – CHECK MAIN GAS SUPPLY PRESSURE

10. Visually check that the high temperature safety limit is set for a 200-230°F range. The limit switch is typically mounted behind the burner control panel.
11. Connect a 0-15" gas pressure gauge or other suitable instrument to the gas manifold port. The gas pressure will be measured when running (refer to step 4 of Burner Start-up Procedure).



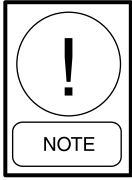
On Powerflame burners this test port is downstream of the main regulator, typically on a standard tee fitting in the main gas line.



On Eclipse burners, this test port is located on the backside of the burner, just below the spark igniter. A small valve is provided at this test port.

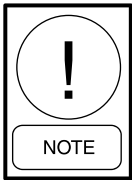
12. Connect a manometer or other suitable device to the Heat Exchanger Draft Port located on the side of the unit near the burner. The expected draft should read slightly negative – about -.03" WC. The draft port is typically made of 3/4" steel pipe and may be plugged. Remove plug and add a small stop valve and a nipple for a rubber tube (see Fig. 3-15 & 3-17).
13. Install the Honeywell S7800 Test Module (display), if available.
14. Connect signal generator (0-20mA) to terminals in place of modulation control signal (for 2-10 VDC signal add a 500 Ω resistor in series). See Fig. 3-24.
15. Visually check that the flue (stack) is secure and connected properly. Typical connections are shown at the end of this guideline (see Fig.'s 3-22 & 3-23).
16. Burner panel off/on switch should be “off”

System is now ready for start up.

BURNER START-UP PROCEDURE

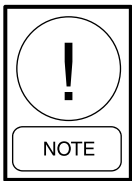
Prior to starting burner, technician must verify incoming gas pressure. A minimum pressure is listed on the “Burner Test Report”. The maximum pressure is listed in Table 3-2.

1. Open manual gas valves on gas supply and pilot line.
2. Initiate a call for heat or use jumper to create call for heat (see Fig. 3-24 for typical wiring diagram).
3. Turn burner panel off-on switch to on.



Once there is a call for heat, a 30 second pre-purge period is initiated to remove any gases from the heat exchanger. The burner will then go through a second purge before ignition.

4. The burner will automatically go to Low Fire at start up. After proof of Low Fire, the burner will modulate up to High Fire. This may take 15 seconds for a Powerflame burner and 90 to 180 seconds for the Eclipse burner. After the burner operates at High Fire use the manometer connected to the Heat Exchanger Draft Port (see Fig. 3-17), observe the reading. A negative pressure of about $-.03$ " WC is expected for draft overfire. Readings may differ slightly from those shown on the “Burner Test Report”.



For valid readings, before making any adjustments, allow the burner to fire at least 20 minutes to allow the heat exchanger to come up to operating temperature.

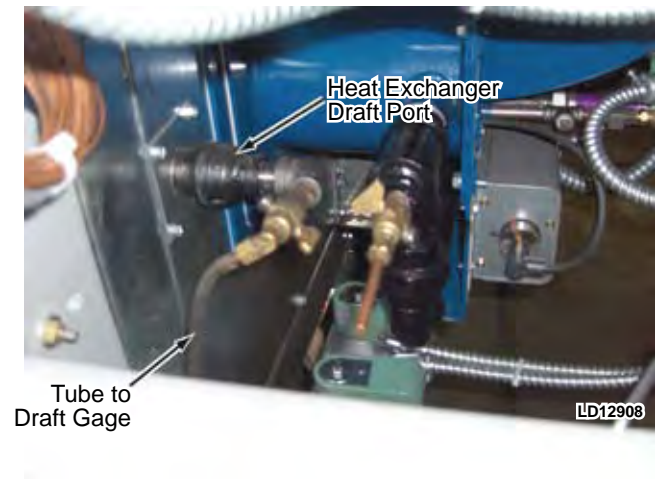
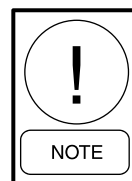


FIG. 3-17 – DRAFT OVER FIRE TEST PORT

5. Observe the gas manifold pressure and compare to data on the “Burner Test Report” under both High Fire and Low Fire conditions.
6. Check the flue (stack) combustion temperature at the ID Blower Housing Test Port. Make sure the test probe is inserted half way into the ID Inlet Tube (see Fig. 3-18). Compare results to the “Burner Test Report”.



FIG. 3-18 – FLUE (STACK) COMBUSTION TEMPERATURE AND EFFICIENCY TEST PORT



Ignition transformer is intermittent. Pilot continues to burn after ignition transformer is de-energized.

- Using the signal generator, cycle the burner to check capacity modulation. Observe valve/damper actuator operation.

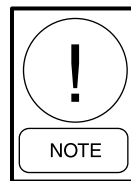


FIG. 3-19 – DAMPER ACTUATOR

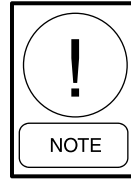
- Using the standard operating controls, cycle the burner several times to assure proper sequencing of start-up, firing, and capacity modulation, plus operation of all safety and monitoring controls.
- Test 180°F. high temp. safety by running burner with airflow off or diverted. Burner will shut down at 180°F. Turn air handler on as quickly as possible to remove heat from the heat exchanger.
- Burner efficiency testing should be done last. The burner should be running at High Fire rate for 30 minutes before efficiency testing is done.
- Efficiency at High Fire is pre-determined, but may be checked by flue gas analysis at the entrance to the ID Blower Housing Test Port. At High Fire CO₂ should be between 8-1/2 and 10 %; O₂ should be between 7-1/2 and 4%. With these ranges, efficiency is 80% plus or minus 2% (see Fig. 3-18).
- Contact contractor, facilities manager or customer to inform successful start-up has been completed.



In the unlikely event that adjustment is required; it is done at High Fire and must NOT retard Low Fire light-off.



Do not change set up of factory preset air inlet dampers on Power Flame burner.



Any questions should be directed to your local Service office or Johnson Controls Product Tech Support, before contacting the burner manufacturer.



FIG. 3-20 – CONDENSATE DRAIN

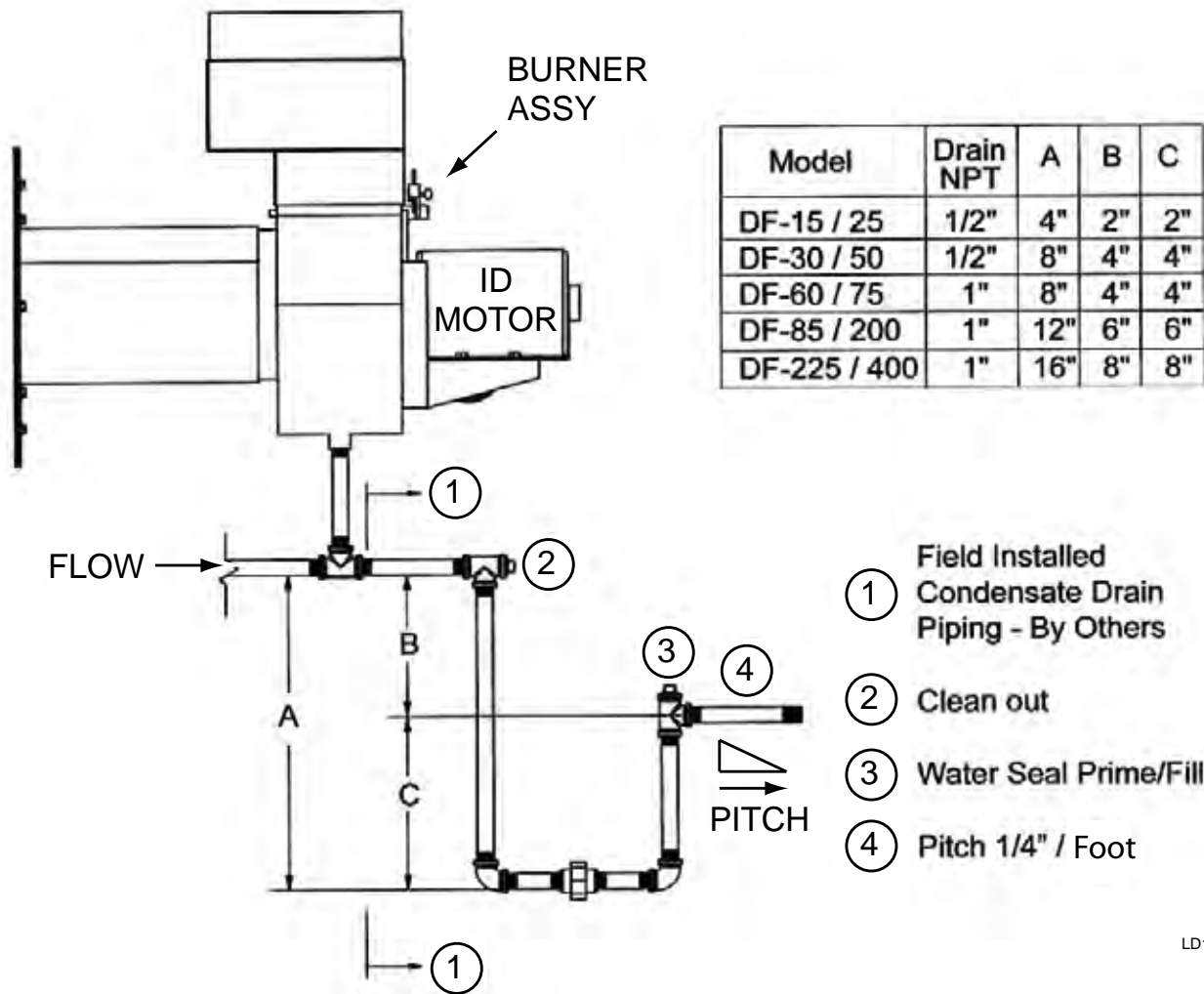
CONDENSATE DRAIN ARRANGEMENT

The YORK Solution Indirect Fired gas heat exchanger has the potential to create highly acidic condensation, particularly during extended operation at low capacity or low firing rate conditions. To insure proper drainage the following guidelines should be followed (See Fig. 3-21).



When constructing the condensate trap for the heat exchanger drainage system, make sure the trap is tall enough to handle the Total Static Pressure of the ID Blower at Low Fire times 2.

Example: TSP is 6” at Low Fire - construct trap 12” tall (See Table in Fig. 3-21).



LD12912

FIG. 3-21 – GAS FURNACE CONDENSATE DRAIN TRAP



Failure to follow these guidelines may cause excessive condensation build up resulting in water damage to the facility and/or a cracked heat exchanger.

1. Observe local jurisdiction codes for gravity condensate drainage requirements.
2. Be sure the air handler is installed at an elevation that enables proper condensate drainage and trapping dimensions as provided in Fig. 3-21. Minimum trap dimensions **MUST** be accommodated.
3. Condensate drain line size must be the full line size of the heat exchanger drain connection.
4. Drain lines, fittings and supports should conform to local codes and be suitable for the application.
5. Condensate drain and trap discharge should be pitched away from the equipment at a slope of 1/4" per linear foot or as local code dictates.
6. For outdoor or unconditioned space installations local climate may dictate the need to heat trace and/or insulate the exposed drain lines and trap. Frozen drain lines and/or trap will cause build up of condensate inside the heat exchanger resulting in leakage and damage to the air handler and possibly to the facility.
7. Provide unions in drain lines to allow removal of trap for periodic cleaning of drain lines as well as the trap. When the burner is operated at low capacity for extended periods, more condensate is generated and with it deposits of solids in the condensate drainage system.
8. Provide the ability to prime the trap. During initial and seasonal start up, trap inspection and priming is required. Condensate in the trap will evaporate during long periods of non-use.

GAS HEAT SEGMENT MODEL NUMBER NOMENCLATURE

| B REV LEVEL | 100 DF SIZE/ CAPACITY MBH | U CODE COMPLIANCE | 3 BURNER TDR | L UNIT HAND YORK DESIGNATION | G ID FAN HOUSING | G UNIT VOLTAGE | A CONTROL VOLTAGE (I ^{STAT} VOLTAGE) | A BURNER MOD CONTROL |
|--------------------------|---|--------------------------------|---------------------------|--|-------------------------------|-----------------------------|---|--------------------------------------|
| A | 15 | A | 3 | L | Galvanized | A | A | A |
| B | 20 | U | 10 | R | Stainless | B | B | B |
| C | 25 | F | 25 | | | C | | C |
| | 30 | R | | | | D | | |
| | 35 | | | | | E | | |
| | 40 | | | | | F | | |
| | 45 | | | | | G | | |
| | 50 | | | | | H | | |
| | 60 | | | | | J | | |
| | 75 | | | | | K | | |
| | 85 | | | | | | | |
| | 100 | | | | | | | |
| | 125 | | | | | | | |
| | 150 | | | | | | | |
| | 175 | | | | | | | |
| | 200 | | | | | | | |
| | 225 | | | | | | | |
| | 250 | | | | | | | |
| | 275 | | | | | | | |
| | 300 | | | | | | | |
| | 325 | | | | | | | |
| | 350 | | | | | | | |
| | 375 | | | | | | | |
| | 400 | | | | | | | |

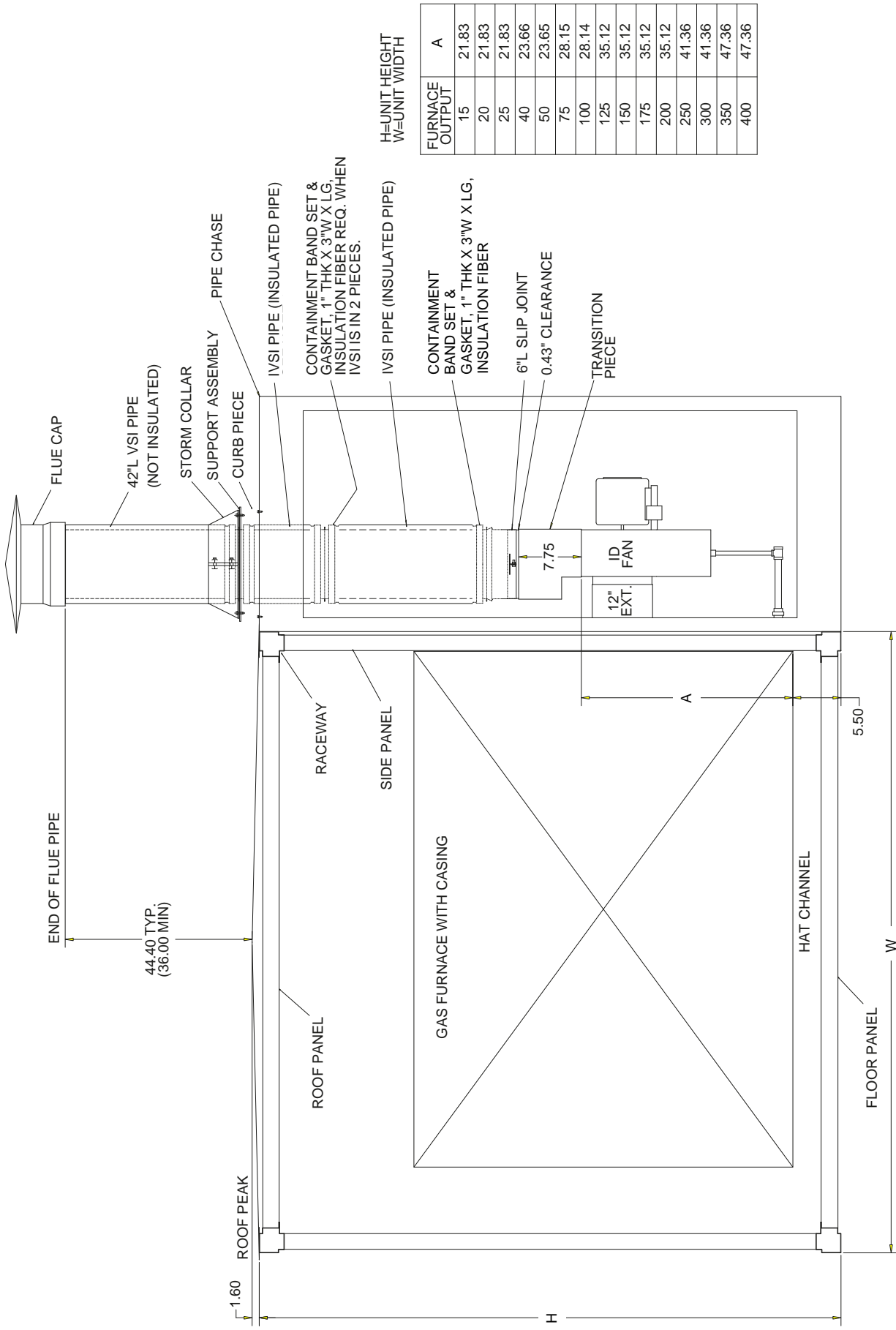
GAS { GAS LP = 2,500 BTU/ CU FT.
 NATURAL = 1,000 BTU/ CU FT.
 Output is approx. 80% of input BTU's

| NOMENCLATURE | | MAXIMUM ALLOW INLET PRESSURE | | | | | | | | | | | | | | MINIMUM INLET PRESSURE TO FIRE | | | | | | | | | | | | | | | | | | | | | | | |
|--------------|-----------------------|---------------------------------|--------|--------|---------|-----------|---------|---------|--------------------|-----------|---------|---------|----------|----------|--------|--------------------------------|---------|-----------|---------|---------|----------|-----------|---------------|---------|----------|----------|--------|--------|---------|-----------|---------|---------|----------|-----------|---------|---------|----------|----|----|
| | | GAS BURNER PIPING/GAS BURNER TD | | | | | | | GAS BURNER PIPING/ | | | | | | | GAS BURNER TD | | | | | | | GAS BURNER TD | | | | | | | | | | | | | | | | |
| | | A03 | U03 | F03 | R03 | A10 | U10 | F10 | R10 | A25 | U25 | F25 | R25 | A03 | U03 | F03 | R03 | A10 | U10 | F10 | R10 | A25 | U25 | F25 | R25 | A03 | U03 | F03 | R03 | A10 | U10 | F10 | R10 | A25 | U25 | F25 | R25 | | |
| GASBTUS | ANSI 3 | UL 3 | FM 3 | IRI 3 | ANSI 10 | UL 10 | FM 10 | IRI 10 | ANSI 25 | UL 25 | FM 25 | IRI 25 | ANSI 3 | UL 3 | FM 3 | IRI 3 | ANSI 10 | UL 10 | FM 10 | IRI 10 | ANSI 25 | UL 25 | FM 25 | IRI 25 | ANSI 3 | UL 3 | FM 3 | IRI 3 | ANSI 10 | UL 10 | FM 10 | IRI 10 | ANSI 25 | UL 25 | FM 25 | IRI 25 | | | |
| OPTION | FURNACE OUTPUT (X10K) | ANSI 3:1 | UL 3:1 | FM 3:1 | IRI 3:1 | ANSI 10:1 | UL 10:1 | FM 10:1 | IRI 10:1 | ANSI 25:1 | UL 25:1 | FM 25:1 | IRI 25:1 | ANSI 3:1 | UL 3:1 | FM 3:1 | IRI 3:1 | ANSI 10:1 | UL 10:1 | FM 10:1 | IRI 10:1 | ANSI 25:1 | UL 25:1 | FM 25:1 | IRI 25:1 | ANSI 3:1 | UL 3:1 | FM 3:1 | IRI 3:1 | ANSI 10:1 | UL 10:1 | FM 10:1 | IRI 10:1 | ANSI 25:1 | UL 25:1 | FM 25:1 | IRI 25:1 | | |
| | 015 | 14.00 | NA | NA | NA | 27.00 | NA | NA | NA | NA | NA | NA | NA | NA | NA | NA | NA | NA | NA | NA | NA | NA | NA | NA | NA | NA | NA | NA | NA | NA | NA | NA | NA | NA | NA | NA | NA | NA | |
| | 020 | 14.00 | NA | NA | NA | 27.00 | NA | NA | NA | NA | NA | NA | NA | NA | NA | NA | NA | NA | NA | NA | NA | NA | NA | NA | NA | NA | NA | NA | NA | NA | NA | NA | NA | NA | NA | NA | NA | NA | NA |
| | 025 | 14.00 | NA | NA | NA | 27.00 | NA | NA | NA | NA | NA | NA | NA | NA | NA | NA | NA | NA | NA | NA | NA | NA | NA | NA | NA | NA | NA | NA | NA | NA | NA | NA | NA | NA | NA | NA | NA | NA | NA |
| | 030 | 14.00 | NA | NA | NA | 27.00 | NA | NA | NA | NA | NA | NA | NA | NA | NA | NA | NA | NA | NA | NA | NA | NA | NA | NA | NA | NA | NA | NA | NA | NA | NA | NA | NA | NA | NA | NA | NA | NA | NA |
| | 035 | NA | 14.00 | NA | NA | 27.00 | NA | 27.00 | NA | NA | NA | NA | NA | NA | NA | NA | NA | NA | NA | NA | NA | NA | NA | NA | NA | NA | NA | NA | NA | NA | NA | NA | NA | NA | NA | NA | NA | NA | NA |
| | 040 | NA | 14.00 | NA | NA | 27.00 | NA | 27.00 | NA | NA | NA | NA | NA | NA | NA | NA | NA | NA | NA | NA | NA | NA | NA | NA | NA | NA | NA | NA | NA | NA | NA | NA | NA | NA | NA | NA | NA | NA | NA |
| | 045 | NA | 14.00 | NA | NA | 27.00 | NA | 27.00 | NA | NA | NA | NA | NA | NA | NA | NA | NA | NA | NA | NA | NA | NA | NA | NA | NA | NA | NA | NA | NA | NA | NA | NA | NA | NA | NA | NA | NA | NA | NA |
| | 050 | NA | 14.00 | NA | NA | 27.00 | NA | 27.00 | NA | NA | NA | NA | NA | NA | NA | NA | NA | NA | NA | NA | NA | NA | NA | NA | NA | NA | NA | NA | NA | NA | NA | NA | NA | NA | NA | NA | NA | NA | NA |
| | 060 | NA | 27.00 | NA | NA | 27.00 | NA | 27.00 | NA | NA | NA | NA | NA | NA | NA | NA | NA | NA | NA | NA | NA | NA | NA | NA | NA | NA | NA | NA | NA | NA | NA | NA | NA | NA | NA | NA | NA | NA | NA |
| | 075 | NA | 27.00 | NA | NA | 27.00 | NA | 27.00 | NA | NA | NA | NA | NA | NA | NA | NA | NA | NA | NA | NA | NA | NA | NA | NA | NA | NA | NA | NA | NA | NA | NA | NA | NA | NA | NA | NA | NA | NA | NA |
| | 085 | NA | 27.00 | NA | NA | 27.00 | NA | 27.00 | NA | NA | NA | NA | NA | NA | NA | NA | NA | NA | NA | NA | NA | NA | NA | NA | NA | NA | NA | NA | NA | NA | NA | NA | NA | NA | NA | NA | NA | NA | NA |
| | 100 | NA | 27.00 | NA | NA | 27.00 | NA | 27.00 | NA | NA | NA | NA | NA | NA | NA | NA | NA | NA | NA | NA | NA | NA | NA | NA | NA | NA | NA | NA | NA | NA | NA | NA | NA | NA | NA | NA | NA | NA | NA |
| | 125 | NA | 27.00 | NA | NA | 27.00 | NA | 27.00 | NA | NA | NA | NA | NA | NA | NA | NA | NA | NA | NA | NA | NA | NA | NA | NA | NA | NA | NA | NA | NA | NA | NA | NA | NA | NA | NA | NA | NA | NA | NA |
| | 150 | NA | 27.00 | NA | NA | 27.00 | NA | 27.00 | NA | NA | NA | NA | NA | NA | NA | NA | NA | NA | NA | NA | NA | NA | NA | NA | NA | NA | NA | NA | NA | NA | NA | NA | NA | NA | NA | NA | NA | NA | NA |
| | 175 | NA | 27.00 | NA | NA | 27.00 | NA | 27.00 | NA | NA | NA | NA | NA | NA | NA | NA | NA | NA | NA | NA | NA | NA | NA | NA | NA | NA | NA | NA | NA | NA | NA | NA | NA | NA | NA | NA | NA | NA | NA |
| | 200 | NA | 27.00 | NA | NA | 27.00 | NA | 27.00 | NA | NA | NA | NA | NA | NA | NA | NA | NA | NA | NA | NA | NA | NA | NA | NA | NA | NA | NA | NA | NA | NA | NA | NA | NA | NA | NA | NA | NA | NA | NA |
| | 225 | NA | NA | 27.00 | 27.00 | 27.00 | NA | 27.00 | 27.00 | NA | NA | NA | NA | NA | NA | NA | NA | NA | NA | NA | NA | NA | NA | NA | NA | NA | NA | NA | NA | NA | NA | NA | NA | NA | NA | NA | NA | NA | NA |
| | 250 | NA | NA | 27.00 | 27.00 | 27.00 | NA | 27.00 | 27.00 | NA | NA | NA | NA | NA | NA | NA | NA | NA | NA | NA | NA | NA | NA | NA | NA | NA | NA | NA | NA | NA | NA | NA | NA | NA | NA | NA | NA | NA | NA |
| | 275 | NA | NA | 27.00 | 27.00 | 27.00 | NA | 27.00 | 27.00 | NA | NA | NA | NA | NA | NA | NA | NA | NA | NA | NA | NA | NA | NA | NA | NA | NA | NA | NA | NA | NA | NA | NA | NA | NA | NA | NA | NA | NA | NA |
| | 300 | NA | NA | 27.00 | 27.00 | 27.00 | NA | 27.00 | 27.00 | NA | NA | NA | NA | NA | NA | NA | NA | NA | NA | NA | NA | NA | NA | NA | NA | NA | NA | NA | NA | NA | NA | NA | NA | NA | NA | NA | NA | NA | NA |
| | 325 | NA | NA | 27.00 | 27.00 | 27.00 | NA | 27.00 | 27.00 | NA | NA | NA | NA | NA | NA | NA | NA | NA | NA | NA | NA | NA | NA | NA | NA | NA | NA | NA | NA | NA | NA | NA | NA | NA | NA | NA | NA | NA | NA |
| | 350 | NA | NA | 27.00 | 27.00 | 27.00 | NA | 27.00 | 27.00 | NA | NA | NA | NA | NA | NA | NA | NA | NA | NA | NA | NA | NA | NA | NA | NA | NA | NA | NA | NA | NA | NA | NA | NA | NA | NA | NA | NA | NA | NA |
| | 375 | NA | NA | 27.00 | 27.00 | 27.00 | NA | 27.00 | 27.00 | NA | NA | NA | NA | NA | NA | NA | NA | NA | NA | NA | NA | NA | NA | NA | NA | NA | NA | NA | NA | NA | NA | NA | NA | NA | NA | NA | NA | NA | NA |
| | 400 | NA | NA | 27.00 | 27.00 | 27.00 | NA | 27.00 | 27.00 | NA | NA | NA | NA | NA | NA | NA | NA | NA | NA | NA | NA | NA | NA | NA | NA | NA | NA | NA | NA | NA | NA | NA | NA | NA | NA | NA | NA | NA | NA |

Note: Gas pressure requirements at the inlet to the main manual shutoff cock of the gas train.

TABLE 3-3 – PIPE SIZE REQUIRED

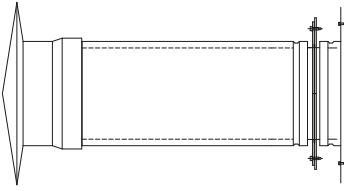
| INLET SIZE (NPT) | | | | | | | | | | | | |
|--|-------------|-----------|-----------|------------|--------------|------------|------------|-------------|--------------|------------|------------|-------------|
| | A03 | U03 | F03 | R03 | A10 | U10 | F10 | R10 | A25 | U25 | F25 | R25 |
| GAS BURNER PIPING/GAS BURNER TURN DOWN | | | | | | | | | | | | |
| | ANSI 3 | UL 3 | FM 3 | IRI 3 | ANSI 10 | UL 10 | FM 10 | IRI 10 | ANSI 25 | UL 25 | FM 25 | IRI 25 |
| FURNACE OUTPUT (X10K) | ANSI 3:1 | UL 3:1 | FM 3:1 | IRI 3:1 | ANSI 10:1 | UL 10:1 | FM 10:1 | IRI 10:1 | ANSI 25:1 | UL 25:1 | FM 25:1 | IRI 25:1 |
| 015 | 0.75 | NA | NA | NA | 1.00 | NA | NA | NA | NA | NA | NA | NA |
| 020 | 0.75 | NA | NA | NA | 1.00 | NA | NA | NA | NA | NA | NA | NA |
| 025 | 0.75 | NA | NA | NA | 1.00 | NA | NA | NA | NA | NA | NA | NA |
| 030 | 0.75 | NA | NA | NA | 1.00 | NA | NA | NA | NA | NA | NA | NA |
| 035 | NA | 1.00 | NA | 1.00 | NA | 1.00 | NA | 1.00 | NA | NA | NA | NA |
| 040 | NA | 1.00 | NA | 1.00 | NA | 1.00 | NA | 1.00 | NA | 1.00 | NA | 1.00 |
| 045 | NA | 1.00 | NA | 1.00 | NA | 1.00 | NA | 1.00 | NA | 1.00 | NA | 1.00 |
| 050 | NA | 1.00 | NA | 1.00 | NA | 1.00 | NA | 1.00 | NA | 1.00 | NA | 1.00 |
| 060 | NA | 1.00 | NA | 1.00 | NA | 1.00 | NA | 1.00 | NA | 1.00 | NA | 1.00 |
| 075 | NA | 1.00 | NA | 1.00 | NA | 1.00 | NA | 1.00 | NA | 1.25 | NA | 1.25 |
| 085 | NA | 1.00 | NA | 1.00 | NA | 1.00 | NA | 1.00 | NA | 1.25 | NA | 1.25 |
| 100 | NA | 1.00 | NA | 1.00 | NA | 1.00 | NA | 1.00 | NA | 1.25 | NA | 1.25 |
| 125 | NA | 1.25 | NA | 1.25 | NA | 1.25 | NA | 1.25 | NA | 1.50 | NA | 1.50 |
| 150 | NA | 1.25 | NA | 1.25 | NA | 1.25 | NA | 1.25 | NA | 1.50 | NA | 1.50 |
| 175 | NA | 1.25 | NA | 1.25 | NA | 1.25 | NA | 1.25 | NA | 1.50 | NA | 1.50 |
| 200 | NA | 1.50 | NA | 1.50 | NA | 1.50 | NA | 1.50 | NA | 1.50 | NA | 1.50 |
| 225 | NA | NA | 2.00 | 1.50 | NA | NA | 2.00 | 1.50 | NA | NA | 2.00 | 2.00 |
| 250 | NA | NA | 2.00 | 1.50 | NA | NA | 2.00 | 1.50 | NA | NA | 2.00 | 2.00 |
| 275 | NA | NA | 2.00 | 1.50 | NA | NA | 2.00 | 2.00 | NA | NA | 2.00 | 2.00 |
| 300 | NA | NA | 2.00 | 1.50 | NA | NA | 2.00 | 2.00 | NA | NA | 2.00 | 2.00 |
| 325 | NA | NA | 2.50 | 2.50 | NA | NA | 2.50 | 2.50 | NA | NA | 2.50 | 2.50 |
| 350 | NA | NA | 2.50 | 2.50 | NA | NA | 2.50 | 2.50 | NA | NA | 2.50 | 2.50 |
| 375 | NA | NA | 2.50 | 2.50 | NA | NA | 2.50 | 2.50 | NA | NA | 2.50 | 2.50 |
| 400 | NA | NA | 2.50 | 2.50 | NA | NA | 2.50 | 2.50 | NA | NA | 2.50 | 2.50 |



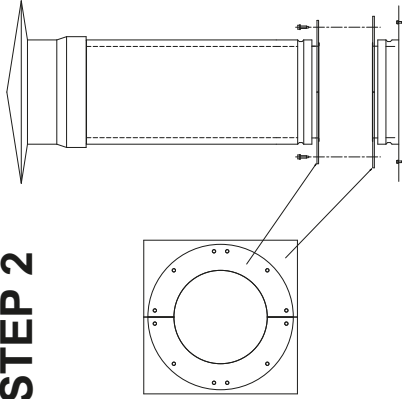
LD13304

FIG. 3-22 – GAS FURNACE FUEL VENTING SYSTEM

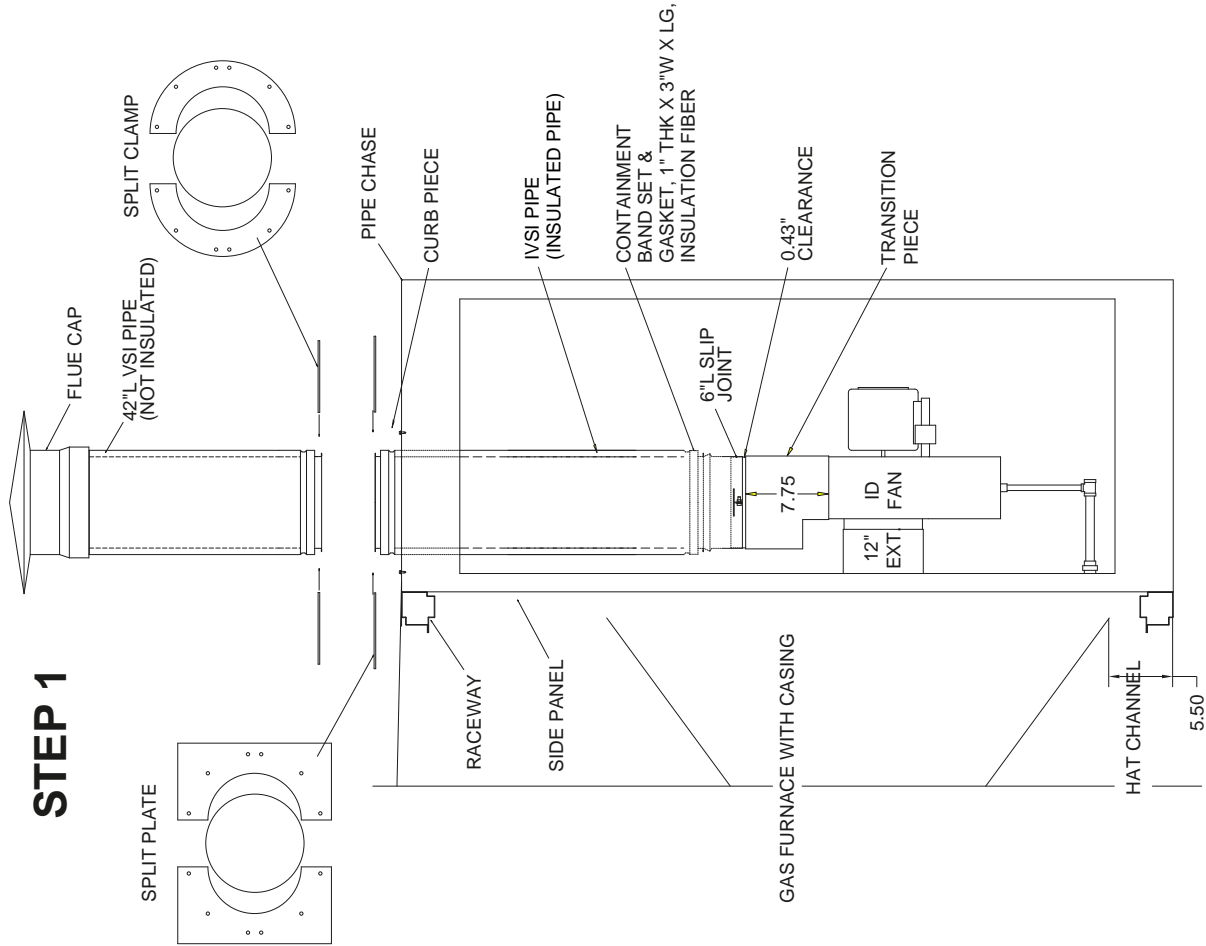
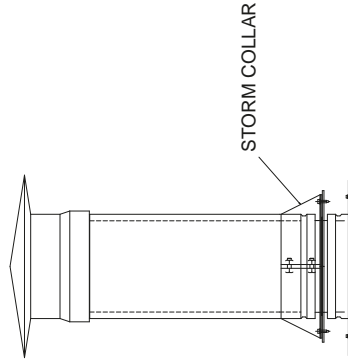
STEP 3



STEP 2



STEP 4



STEP 1

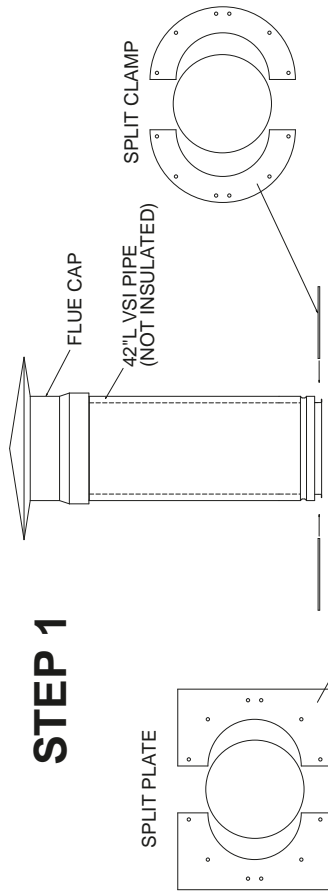


FIG. 3-23 – GAS FURNACE FUEL VENTING SYSTEM

FOR REFERENCE ONLY

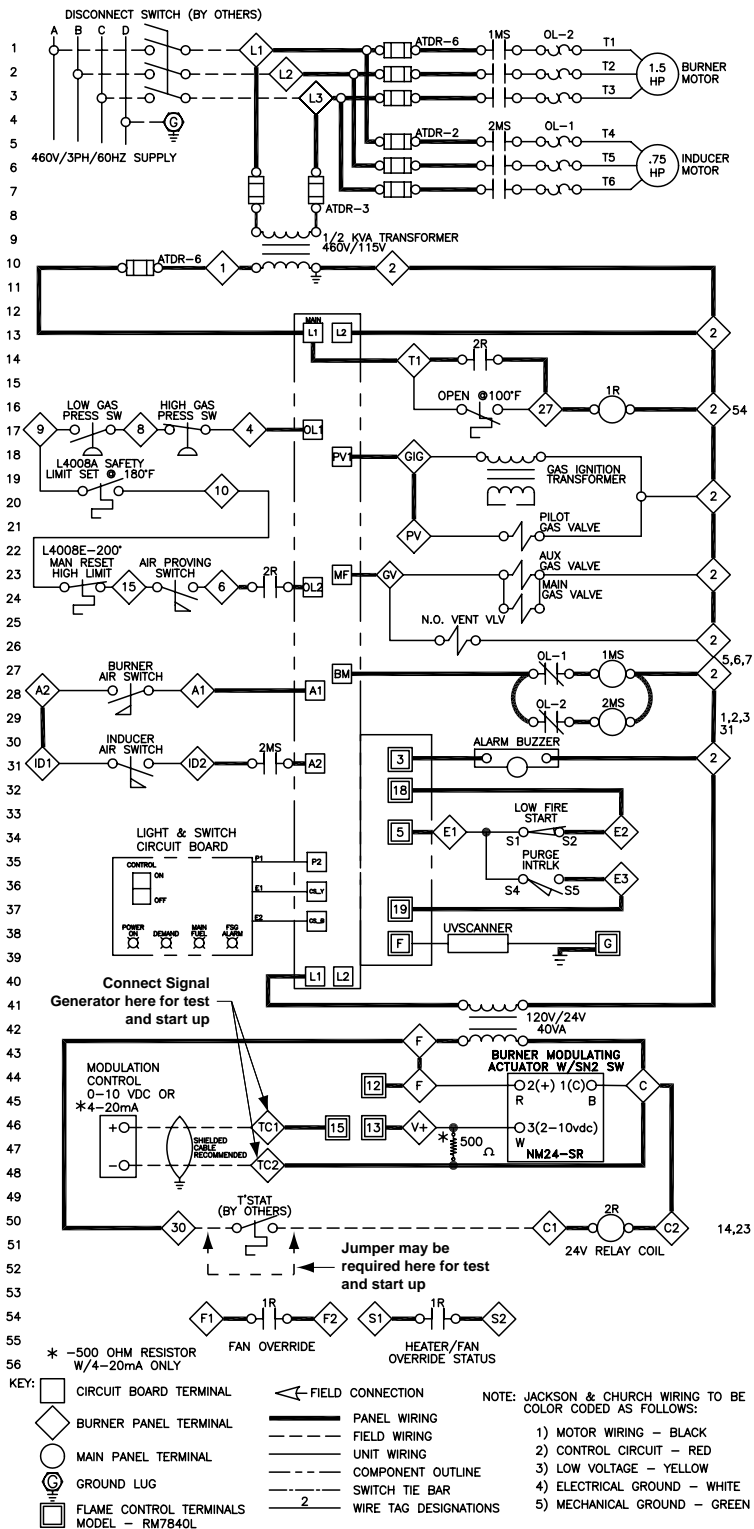


FIG. 3-24 – TYPICAL WIRING DIAGRAM

LD13315

TABLE 3-4 – BURNER TEMPERATURE RISE

| CFM | TEMPERATURE RISE (°F) | | | INTERNAL PRESSURE DROP “ WC |
|--------|-----------------------|-----------|-----------|--------------------------------------|
| | DF- 15 | DF- 20 | DF- 25 | |
| 1,500 | 91 | -- | -- | 0.17 |
| 2,000 | 68 | 91 | -- | 0.29 |
| 2,500 | 55 | 73 | 91 | 0.46 |
| 3,000 | 46 | 61 | 76 | 0.65 |
| 3,500 | 40 | 52 | 65 | 0.89 |
| 4,000 | 35 | 46 | 57 | 1.17 |
| 4,500 | 31 | 41 | 51 | 1.47 |
| 5,248 | 26 | 35 | 44 | 2 |
| | DF- 30 | DF- 35 | DF- 40 | |
| 3,000 | 95 | -- | -- | 0.22 |
| 3,500 | 82 | 91 | -- | 0.31 |
| 4,000 | 71 | 79 | 95 | 0.41 |
| 4,500 | 63 | 70 | 85 | 0.54 |
| 5,000 | 57 | 63 | 76 | 0.66 |
| 5,500 | 52 | 57 | 69 | 0.84 |
| 6,000 | 47 | 53 | 63 | 1 |
| 6,500 | 43 | 47 | 58 | 1.2 |
| 7,000 | 40 | 46 | 54 | 1.45 |
| 8,440 | 32.9 | 38.4 | 43.9 | 2 |
| | DF- 45 | DF- 50 | | |
| 4,500 | 88 | -- | | 0.39 |
| 5,000 | 80 | 90 | | 0.47 |
| 5,500 | 72 | 82 | | 0.55 |
| 6,000 | 66 | 75 | | 0.65 |
| 6,500 | 61 | 69 | | 0.75 |
| 7,000 | 57 | 64 | | 0.86 |
| 7,500 | 53 | 60 | | 0.98 |
| 8,000 | 50 | 56 | | 1.1 |
| 8,500 | 47 | 53 | | 1.23 |
| 9,000 | 46 | 50 | | 1.38 |
| 10,725 | 38.8 | 43.2 | | 2 |

| CFM | TEMPERATURE RISE (°F) | | | INTERNAL PRESSURE DROP “ WC |
|--------|-----------------------|------------|--|--------------------------------------|
| | DF- 60 | DF- 75 | | |
| 6,000 | 91 | -- | | 0.44 |
| 6,500 | 84 | -- | | 0.52 |
| 7,000 | 78 | -- | | 0.6 |
| 7,500 | 73 | 91 | | 0.68 |
| 8,000 | 68 | 85 | | 0.78 |
| 9,000 | 61 | 76 | | 0.98 |
| 10,000 | 55 | 68 | | 1.2 |
| 11,000 | 50 | 62 | | 1.4 |
| 12,000 | 46 | 57 | | 1.7 |
| 12,900 | 43 | 53.8 | | 2 |
| | DF- 85 | DF- 100 | | |
| 8,500 | 91 | -- | | 0.47 |
| 9,000 | 86 | -- | | 0.52 |
| 9,500 | 81 | -- | | 0.58 |
| 10,000 | 77 | 91 | | 0.64 |
| 10,500 | 74 | 87 | | 0.7 |
| 11,000 | 70 | 83 | | 0.76 |
| 12,000 | 64 | 76 | | 0.9 |
| 13,000 | 59 | 70 | | 1.05 |
| 14,000 | 55 | 65 | | 1.25 |
| 15,000 | 51 | 61 | | 1.4 |
| 16,000 | 49 | 57 | | 1.6 |
| 17,000 | 46 | 54 | | 1.75 |
| 17,825 | 44 | 52 | | 2 |

TABLE 3-4 - BURNER TEMPERATURE RISE (CONT)

| CFM | TEMPERATURE RISE (°F) | | | | INTERNAL PRESSURE DROP " WC |
|--------|-----------------------|--------|--|--|-----------------------------|
| | DF-125 | DF-150 | | | |
| 13,000 | 89 | -- | | | 0.48 |
| 14,000 | 83 | -- | | | 0.56 |
| 15,000 | 77 | 93 | | | 0.65 |
| 16,000 | 72 | 87 | | | 0.73 |
| 17,000 | 68 | 82 | | | 0.82 |
| 18,000 | 64 | 77 | | | 0.92 |
| 19,000 | 61 | 73 | | | 1.03 |
| 20,000 | 58 | 69 | | | 1.13 |
| 21,000 | 55 | 66 | | | 1.25 |
| 22,000 | 52 | 63 | | | 1.35 |
| 23,000 | 50 | 60 | | | 1.5 |
| 24,000 | 48 | 58 | | | 1.3 |
| 25,000 | 46 | 55 | | | 1.75 |
| 26,315 | 43.6 | 52 | | | 2 |
| | DF-175 | DF-200 | | | |
| 17,000 | 95 | -- | | | 0.45 |
| 18,000 | 90 | -- | | | 0.52 |
| 19,000 | 85 | -- | | | 0.57 |
| 20,000 | 81 | 93 | | | 0.63 |
| 21,000 | 77 | 88 | | | 0.7 |
| 22,000 | 74 | 85 | | | 0.76 |
| 23,000 | 71 | 81 | | | 0.82 |
| 24,000 | 68 | 78 | | | 0.9 |
| 26,000 | 62 | 71 | | | 1.05 |
| 28,000 | 58 | 66 | | | 1.25 |
| 30,000 | 54 | 62 | | | 1.4 |
| 32,000 | 51 | 58 | | | 1.6 |
| 34,000 | 48 | 54 | | | 1.8 |
| 35,635 | 45.5 | 52 | | | 2 |

| CFM | TEMPERATURE RISE (°F) | | | | INTERNAL PRESSURE DROP " WC |
|--------|-----------------------|--------|--------|--------|-----------------------------|
| | DF-225 | DF-250 | DF-275 | DF-300 | |
| 24,000 | 87 | -- | -- | -- | 0.337 |
| 27,000 | 77 | 86 | 92.5 | -- | 0.427 |
| 30,000 | 69 | 77 | 83.3 | 90.8 | 0.527 |
| 33,000 | 63 | 70 | 75.8 | 82.5 | 0.637 |
| 36,000 | 58 | 64 | 69.5 | 75.7 | 0.758 |
| 39,000 | 53 | 59 | 64 | 70 | 0.89 |
| 42,000 | 50 | 55 | 59.5 | 65 | 1.035 |
| 45,000 | 46 | 51 | 55.6 | 60.6 | 1.185 |
| 48,000 | 43 | 48 | 52.1 | 55.8 | 1.35 |
| 51,000 | 41 | 45 | 50 | 53.5 | 1.525 |
| 54,000 | 39 | 43 | 47 | 50.5 | 1.71 |
| 58,475 | 35 | 39.5 | 43.5 | 47.5 | 2 |
| | DF-325 | DF-350 | DF-375 | DF-400 | |
| 31,565 | 95 | -- | -- | -- | 0.4 |
| 35,290 | 85 | 92 | -- | -- | 0.5 |
| 41,755 | 72 | 78 | 83 | 89 | 0.7 |
| 47,345 | 64 | 68 | 73 | 78 | 0.9 |
| 52,340 | 57 | 62 | 66 | 71 | 1.1 |
| 54,665 | 55 | 59 | 64 | 68 | 1.2 |
| 59,045 | 51 | 55 | 59 | 63 | 1.4 |
| 63,125 | 48 | 51 | 55 | 59 | 1.6 |
| 66,950 | 45 | 48 | 52 | 55 | 1.8 |
| 70,573 | 42.6 | 45.9 | 49.2 | 52.4 | 2 |

ELECTRIC HEAT STARTUP

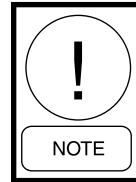


Rotating parts and electrical shock hazards exist. Lock out and tag out the fan motor(s) and heat power disconnects before servicing. FOLLOW THE LATEST "LOCKOUT TAGOUT" PROCEDURE. Failure to follow proper safety precautions may result in serious injury or death

All electrical connections in the heater, including both field and factory made connections, should be checked for tightness before operating the heater. In addition, after a short period of operation, all connections should again be checked for tightness.



DO NOT operate electric heat below the minimum airflow requirement.



Ensure filters are clean and airflow is at minimum requirement or greater. Preferably 100 % for this start up procedure.

To operate this heater make sure all associated control equipment is on, energize main supply disconnect and set controlling thermostat above ambient temperature. This heater is equipped with automatic and manual reset temperature limiting controls. If it fails to operate, make sure manual resets are operative by pushing reset buttons.

AIRFLOW REQUIREMENTS

Calculate KW per square foot of duct area as: $\frac{\text{heater nameplate KW}}{\text{duct area (Sq.Ft.)}}$ (see step 12)

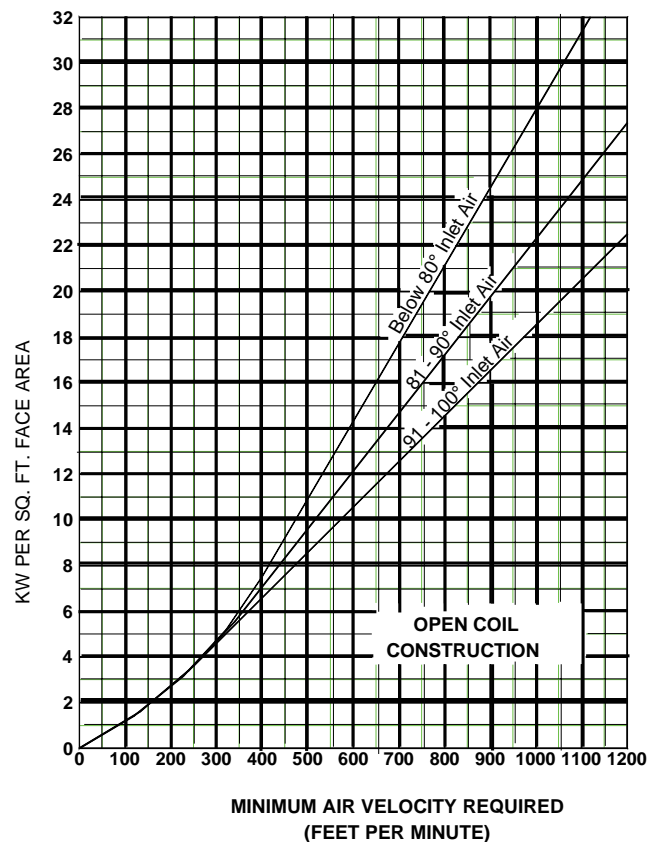
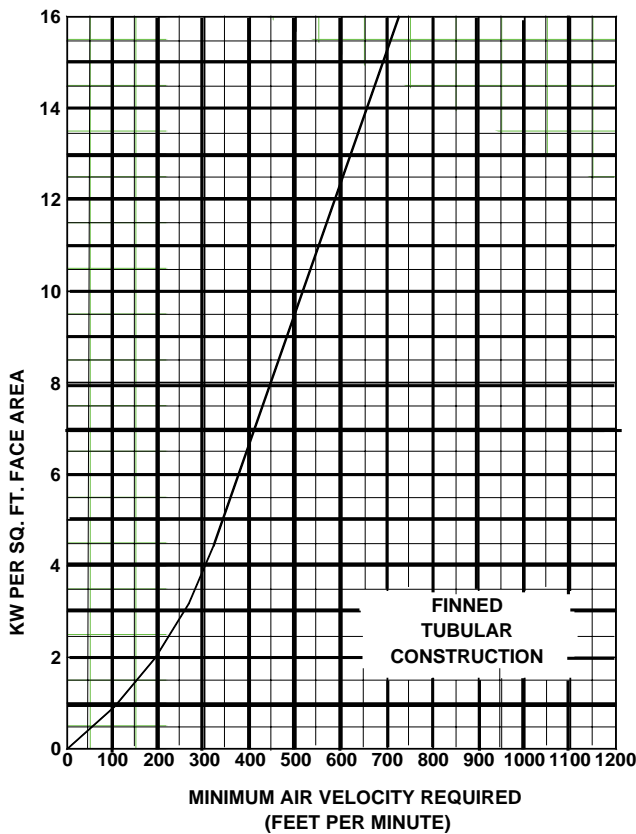
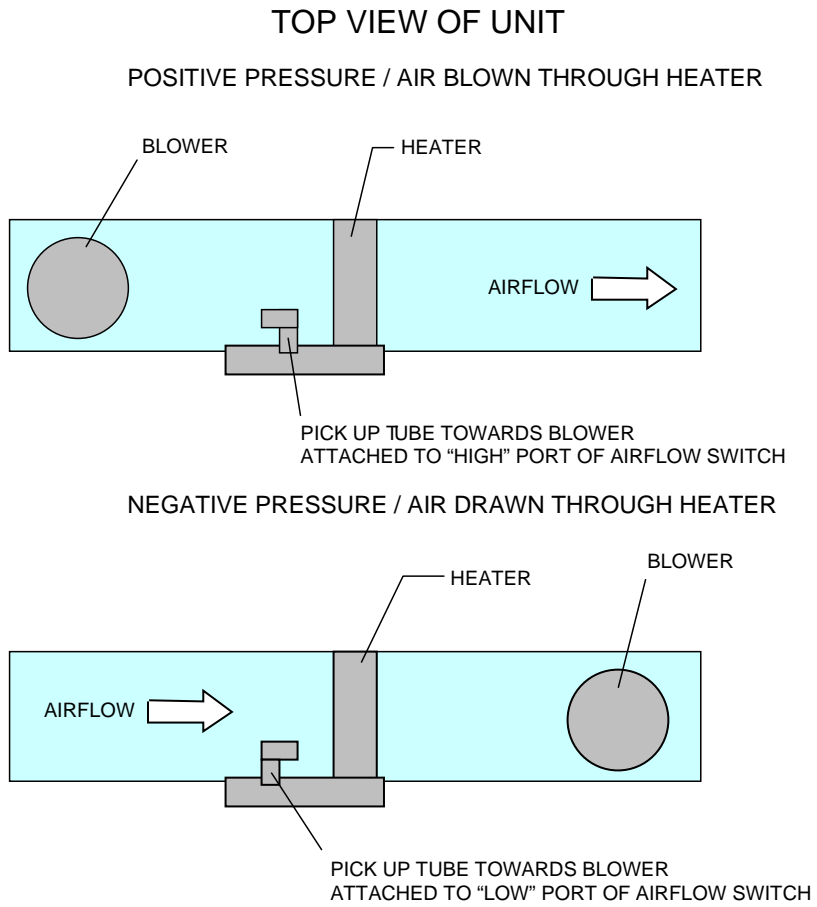
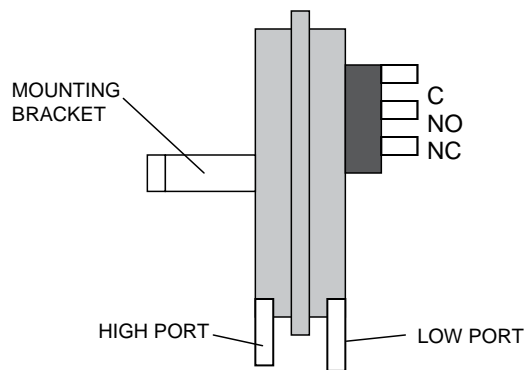


FIG. 3-25 – MINIMUM AIR VELOCITY REQUIRED FOR SAFE OPERATION




LD14268

FIG. 3-26 – PRESSURE PROBE DIRECTION



LD14270

FIG. 3-27 – AIRFLOW SWITCH CONNECTIONS

| | | |
|---|------------------------------|-----------------------|
|  BY JOHNSON CONTROLS | AIR HANDLING UNITS | |
| START-UP CHECKLIST | Supersedes: 100.00-CL1 (309) | Form 100.00-CL1 (909) |

AIR HANDLER START-UP CHECKLIST

| | |
|------------------------------------|---------------------|
| OFFICE LOCATION _____ | unit tag # _____ |
| Qualified TECHNICIAN _____ | unit model # _____ |
| JOB NAME _____ | UNIT SERIAL # _____ |
| YORK JOB ID OR CONTRACT # _____ | START DATE _____ |
| JOB SITE LOCATION _____ | |
| JOB SITE CONTACT AND PHONE # _____ | |

IMPORTANT SAFETY REQUIREMENT: FOLLOW THE LATEST “LOCK OUT TAG OUT” PROCEDURE.

PRE START-UP

GENERAL UNIT INSPECTION

Identify and perform appropriate “lock out/tag out” and safety rules. For details on points below see appropriate section of the Installation Instruction provided with each air handler.

For VFD equipped air handlers, refer to the VFD forms for additional requirements.



Serious damage to the AHU and/or system is eminent if the AHU is operated under any of the following conditions:

- *Without proper control of dampers.*

- *With smoke dampers closed.*
- *During a fire alarm or smoke purge test.*
- *Any airflow restriction greater than normal.*

| | | | | | | | |
|----------|----------|------|-------------|---------------|-----|------|------------|
| Solution | AH Units | Form | 102.20-NOM1 | Air Modulator | VFD | Form | 100.41-NO1 |
| Custom | AH Units | Form | 100.31-NOM1 | | | | |

| | |
|---|--|
| <input type="checkbox"/> Equipment received as ordered. | <input type="checkbox"/> Verify all ductwork is complete and available for full air flow. |
| <input type="checkbox"/> Unit checked for damage to interior and exterior. | <input type="checkbox"/> Unit installed with proper clearances. |
| <input type="checkbox"/> Unit installed on flat and level surface. Outdoor unit mounted within roof slope limitations where applicable. | <input type="checkbox"/> Visually inspect roof curb for tight seal around unit. |
| <input type="checkbox"/> Terminal screws and wiring connections secure in control, electric and Air Modulator panels. | <input type="checkbox"/> Clean air filters installed properly and secured. |
| <input type="checkbox"/> Air hoods installed properly. | <input type="checkbox"/> Filter gauge set to zero. |
| <input type="checkbox"/> Condensate drain properly trapped. | <input type="checkbox"/> All field wiring complete and inspected. |
| <input type="checkbox"/> All wiring and tubing connections made at shipping splits. | <input type="checkbox"/> All shipping splits sealed and secured properly. |
| <input type="checkbox"/> All field piping connections complete. | <input type="checkbox"/> Pipe chase floor sealed at penetrations. |
| <input type="checkbox"/> All shipped loose parts installed. | <input type="checkbox"/> All shipping bolts and other material have been removed. (Fan, VIFB, Energy Recovery Wheel, Damper). |
| <input type="checkbox"/> Installer has cleaned out interior. | <input type="checkbox"/> Damper linkage is tight and in correct “power off” position. |
| <input type="checkbox"/> Verify all plug-ins and wire connections are tight on UV equipment. | <input type="checkbox"/> Controls installation complete. |
| <input type="checkbox"/> Verify Energy Recovery Wheel turns freely and wheel segments are fully engaged. | <input type="checkbox"/> Verify correct piping of split system. Reference Section 2 of Solution IOM & Split System Application Guide (050.40-ES3). |

Fan INSPECTION

| | |
|---|--|
| <input type="checkbox"/> Check bearings and locking collars for properly tightened setscrews, bolts and nuts. | <input type="checkbox"/> Fan wheel properly aligned, tight on shaft and freely moving. |
| <input type="checkbox"/> Sheaves properly aligned and tight on shaft. | <input type="checkbox"/> Check fan base isolators and thrust restraints for proper adjustment. Note: Do not remove functional bolts from seismic isolators. |
| <input type="checkbox"/> Belt tension adjusted properly per drive pkg. label on fan. | <input type="checkbox"/> Fan bearings have been re-lubricated properly. |
| <input type="checkbox"/> Check fan alignment with unit discharge. Adjust with isolation. | |

START-UP

PERFORM THE FOLLOWING STEPS IN ORDER:

Refer to safety standards. Ensure all door latches are secured before starting.

| | |
|---|---|
| <input type="checkbox"/> 1. With all Electric Power off, all disconnect switches open and fuses removed, check each circuit with an Ohm meter to ground observing no continuity. Reinstall fuses. | <input type="checkbox"/> 8. Immediately check current draw of each leg of each motor. |
| <input type="checkbox"/> 2. Energize power to the unit disconnect switch. | <input type="checkbox"/> 9. VFD, refer to manufactures start up guide |
| <input type="checkbox"/> 3. Verify correct voltage, phase and cycles. | <input type="checkbox"/> 10. Check doors and latches for air leaks. |
| <input type="checkbox"/> 4. Energize fan motor(s) briefly (bump) and check for correct fan rotation. | <input type="checkbox"/> 11. Check for obvious audible leaks. |
| <input type="checkbox"/> 5. Check operation of dampers. Insure unit will not operate with all dampers closed. | <input type="checkbox"/> 12. Apply steam to cold coils slowly to prevent damage. |
| <input type="checkbox"/> 6. Energize fan motor(s). Observe fan(s) for smooth operation. | <input type="checkbox"/> 13. Observe energy recovery wheel rotation. |
| <input type="checkbox"/> 7. Check motor nameplate Full Load Amp rating. | |

RECORD DATA

POWER SUPPLY: Unit Nameplate V___ PH___ CYC, ___ Verify V _____/ _____/ _____

| | | |
|---------------------------|------------------------------|-------------------------------------|
| DATA | SUPPLY FAN MOTOR | EXHAUST/RETURN FAN MOTOR |
| Nameplate | Volts _____ Amps _____ | Volts _____ Amps _____ |
| Run Amps | _____ / _____ / _____ | _____ / _____ / _____ |
| Catalog Number | _____ | _____ |
| Spec Number | _____ | _____ |
| Horse Power | _____ | _____ |
| RPM | Nameplate _____ Actual _____ | Nameplate _____ Actual _____ |
| Frame size | _____ | _____ |
| Service Factor | _____ | _____ |
| Jump (Skip) Frequencies | _____ / _____ / _____ | _____ / _____ / _____ |
| | SUPPLY FAN | EXHAUST/RETURN FAN |
| Manufacture Name | _____ | _____ |
| Type or Model Number | _____ | _____ |
| Code or Shop Order Number | _____ | _____ |
| Serial Number | _____ | _____ |
| | SUPPLY FAN DRIVE KIT | EXHAUST/RETURN FAN DRIVE KIT |
| Belts (Qty & ID #) | _____ | _____ |
| Belt Tension | Tag _____ Actual _____ | Tag _____ Actual _____ |
| Fan RPM (DN) | Tag _____ Actual _____ | Tag _____ Actual _____ |

other utilities

| | | |
|------------------------------|-------------------------|--------------------------------|
| Steam Pressure | Heating Coils ___ PSI, | Humidifier ___ PSI |
| Hot Water Pressure/Temp. | Supply ___ PSI, ___ °F, | Return ___ PSI, ___ °F |
| Chilled Water Pressure/Temp. | Supply ___ PSI, ___ °F, | Return ___ PSI, ___ °F |
| Potable Water Pressure | ___ PSI, | Pneumatic Air Pressure ___ PSI |

MAINTENANCE

Upon completion of start-up the customer assumes responsibility for periodic maintenance of this equipment in order to continue warranty. Refer to the Installation Operation and Maintenance Manual (Form 102.20-NOM1).

Customer's agent signature: _____ **Date:** _____



| TABLE 3-5 – INSPECTION REQUIREMENTS | |
|---|--|
| ITEM | YORK SOLUTION INSTRUCTION LOCATION |
| Pre Start-up | |
| Equipment received as ordered. | Section 1, Inspection ▶ |
| Unit checked for damage interior and exterior. | Section 1, Inspection ▶ |
| Verify unit installed on flat and level surface. Outdoor unit mounted within roof slope limitations where applicable. | Section 2, Site Preparation |
| Terminal screws and wiring connections tightened in control, electric and Air Modulator panels. | Section 2, Electrical Connections ▶ Section 3, Pre-Startup ▶ |
| Air hoods installed properly. | Section 2, Hood Installation with Optional Mist Eliminators ▶ |
| Condensate drain properly trapped. | Section 2, Condensate Drain Trap ▶ |
| All wiring and tubing connections made at shipping splits. | Section 2, Assembly of Outdoor Units ▶ and Assembly of Indoor Units ▶ |
| All field piping connections complete. | Section 2, Coil Piping ▶ |
| All shipped loose parts installed. | Section 1, Checking For Non Mounted Parts ▶ |
| Installer has cleaned out interior. | |
| Make sure all ductwork is complete and available for full airflow. | Section 2, Duct Connections ▶ Section 3, Startup ▶ |
| Unit installed with proper clearances. | Section 2, Outdoor Units Site Prep. ▶ Section 2, Indoor Units Site Prep. ▶ |
| Visually inspect roof curb for tight seal around unit. | Section 2, Curb; Assembly & Installation Instructions ▶ |
| Clean air filters installed properly and secured. | Section 2, Air Filters ▶ |
| Filter gauge set to zero. | |
| All field wiring complete and inspected. | <i>See Notes in General Safety Guidelines ▶, Pre-installation ▶ & Installation. ▶</i> Section 2, Electrical Connections ▶ IOM Section 6, Wiring Diagrams ▶ |
| All shipping splits sealed and secured properly. | Section 2, Installing Multiple Piece Outdoor Unit ▶ Installing Multiple Piece Indoor Unit ▶ and Installation Of Tiered Unit ▶ |
| Pipe chase floor sealed at penetrations. | Section 2, Pipe Chase Installation ▶ |
| All shipping bolts and other material have been removed. (Fan, VIFB, Energy Recovery Wheel, Damper). Note: Do not remove functional bolts from seismic isolators. | Section 2, VIFB & IFB Section 3, Pre Start-up ▶ |
| Damper linkage is tight and in correct “power off” position. | Section 3, Pre Start-up ▶ |
| Verify correct piping of split system. | Section 2 & Split System Application Guide (050.40-ES3). |
| FAN INSPECTION | |
| Check bearings and locking collars. | Section 3, Pre Start-up Fan Assembly Inspection ▶ |
| Sheaves properly aligned and tight on shaft. | Section 3, Belts & Sheaves ▶ IOM Section 4, Sheave Alignment ▶ |
| Belt tension adjusted properly per drive pkg. label on fan. | IOM Section 4, Belts ▶ |
| Check fan alignment with unit discharge. Adjust with isolator. | Section 3, Preparing Fan Isolators for Operation ▶ |
| Fan wheel properly aligned, tight on shaft and freely moving. | IOM Section 5, Fan Repair ▶ |

TABLE 3-5 - INSPECTION REQUIREMENTS (CONT.)

| ITEM | YORK SOLUTION INSTRUCTIONS |
|---|--|
| Check fan base isolators and thrust restraints for proper adjustment. | Section 3, Isolators ▶ IOM Section 5, Isolator Adjustment ▶ IOM Section 5, Thrust Restraint Replacement & Adjustment ▶ |
| Fan bearings properly lubricated. | IOM Section 4, Fan Bearing Lubrication ▶ |
| START-UP | |
| Energize power to the unit disconnect switch. | Section 3, Start-up ▶ |
| Verify correct voltage, phase and cycles. | Section 2, Electrical Connections ▶ |
| Energize fan motor(s) briefly (bump) and check for correct fan rotation. | Section 3, Start-up ▶ |
| Check operation of dampers. Insure unit will not operate with all dampers closed. | Section 3, Start-up ▶ |
| Energize fan motor(s). Observe fan(s) for smooth operation. | Section 3, Start-up-Energize Fan Motor ▶ |
| Check motor nameplate Full Load Amp rating. | Section 3, Start-up-Energize Fan Motor ▶ Section 2, Electrical Connections ▶ |
| Immediately check current draw of each leg of each motor. | Section 3, Start-up-Energize Fan Motor ▶ Section 2, Electrical Connections ▶ |
| VFD, <i>refer to manufactures start engine guide.</i> | Section 3, Setup of Non-factory Mounted VFD ▶ IOM Section 4, Dynamic Balance ▶ |
| Check damper operation. | Section 3, Start-up-Check Operation of Dampers ▶ IOM Section 4, Economizer Segment ▶ |
| Check doors and latches for proper adjustment. | IOM Section 4, Air Handler Cabinet-Hardware Check ▶ IOM Section 5, Door Handle/latch Replacement And Adjustment ▶ |
| Check doors for air leaks. | IOM Section 5, Door Replacement ▶ IOM Section 5, Door Gasket Replacement ▶ |
| Controls installation complete. | Section 3, Pre Start-Up ▶ |
| Verify Energy Recovery Wheel turns freely and wheel segments are fully engaged. | Section 3, Start-up Procedure For Energy Recovery Wheel ▶ |

4.0 OPERATION & MAINTENANCE



Refer to ASHRAE 62-2001 for startup and maintenance practices related to achieving acceptable indoor air quality. ASHRAE standard 62-2001 is under continuous maintenance by a Standing Standard Project Committee (SSPC) for which the Standards Committee has established a documented program for regular publication of addenda or revisions, including procedures for timely, documented, consensus action on requests for change to any part of the standard (see Table 4-1).



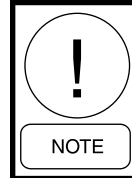
DO NOT PENETRATE WIREWAYS in any manner. These sheet metal channels, which run along the top panel, contain electrical wires and connections. Electrical shock and/or damage to the unit may result.



Do not weld or use torches on the exterior or interior of the unit housing. The housing contains polyurethane insulation, which when under combustion will produce harmful, toxic gases resulting in personal injury or death.



Rotating parts and electrical shock hazards exist. Lock out and tag out the fan motor(s) and heat power disconnects before servicing. FOLLOW THE LATEST "LOCKOUT TAGOUT" PROCEDURE. Failure to follow proper safety precautions may result in serious injury or death. Refer to general safety guidelines and safety symbols located at the front of this Manual. ►



Never use silicone caulk/sealant or caulk/sealant containing silicone in or on any air handling equipment. [Only exception is when provided (high temperature) with gas heat venting].

OPERATION

TEST AND BALANCE

AIR BALANCE

- System air balance should be performed as soon as possible after air handler startup.
- Failure to perform air balance may result in damage to air handler, generate noise and vibration.
- A qualified air balance technician should perform air balance.

DYNAMIC BALANCE

- Dynamic balance has been performed at the factory on the fan assemblies. If any changes were made to the fan assembly (fan, motor, sheaves, belts, isolators, support structure) a vibration analysis must be performed and the fan assembly trim balanced if needed.
- Dynamic balance is affected by operation of Variable Frequency Drives. *If VFD is applied, see cautions in VFD Start-up literature.* Be sure skip frequencies (jump frequencies) are installed prior to operation of motors for more than 30 minutes. *Refer to caution under Section 3 "Set-Up of a Non-Factory Mounted VFD" ► or refer to IOM provided with the VSD.*



Always replace RED metal tab on access doors that provide access to moving parts. This mechanical protection from moving parts is required by UL-1995.

Always replace RED metal tab on access doors that provide access to pressurized areas. This mechanical protection is to prevent accidental release of access doors under positive pressure.



Verify conformance with the total outdoor airflow and space supply airflow requirements of ASHRAE Standard 111, SMACNA's HVAC Systems - Testing, Adjusting and Balancing, 2nd edition, or equivalent.

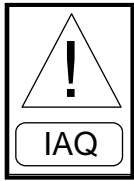


TABLE 4-1 – MINIMUM MAINTENANCE ACTIVITY AND FREQUENCY (ASHRAE STANDARD 62-2001 FOR INDOOR AIR QUALITY).

Refer to Fig. 4-32 - “Maintenance Requirements for YORK Solution Air Handler (includes suggested IAQ minimums for ASHRAE STD. 62-2001 Compliance”.

| Item | Activity | Minimum Frequency |
|--|----------|---|
| Filters and air cleaning devices | A | According to O & M Manual |
| Outdoor air dampers and actuators | B | Every three months or in accordance with O & M Manual |
| Humidifiers | C | Regularly when it is likely that dehumidification occurs but no less than once per year or as specified in the O & M Manual |
| Dehumidification coils | D | Once per year during cooling season or as specified in the O & M Manual |
| Drain pans and other adjacent surfaces subject to wetting | D | Every six months or as specified in the O & M Manual |
| Outdoor air intake louvers, bird screens, mist eliminators, and adjacent areas | E | Every six months or periodically specified in accordance with the O & M Manual |
| Sensors used for dynamic minimum outdoor air control | F | Every six months or periodically in accordance with O & M Manual |
| Air-handling systems except for units under 1000 L/s (2000 CFM) | G | Once every five years |
| Cooling towers | H | In accordance with the O & M Manual or treatment system provider |
| Floor drains located in plenums or rooms that serve as air plenums | I | Periodically according to O & M Manual |
| Equipment / component accessibility | J | |
| Visible microbial contamination | K | |
| Water intrusion or accumulation | K | |

ACTIVITY CODE:

- A. Maintain according to O & M Manual.
- B. Visually inspect or remotely monitor for proper function.
- C. Clean and maintain to limit fouling and microbial growth.
- D. Visually inspect for cleanliness and microbial growth and clean when fouling is observed.
- E. Visually inspect for cleanliness and integrity and clean when necessary.
- F. Verify accuracy and recalibrate or replace as necessary.
- G. Measure the minimum quantity of outdoor air. If measured minimum airflow rates are less than 90% of the minimum outdoor rate in the O & M Manual, they shall be adjusted or modified to bring them above 90% or shall be evaluated to determine if the measured rates are in conformance with this standard.
- H. Treat to limit the growth of microbial contaminants.
- I. Maintain to prevent transport of contaminants from the floor drain to the plenum.
- J. Keep clear the space provided for routine maintenance and inspection around ventilation equipment.
- K. Investigate and rectify.

* Minimum frequencies may be increased or decreased if indicated in the O & M Manual.

TEMPERATURE LIMITS

Cabinet Panels - 200° F.
 Standard Motors with (Class B Insulation) - 104°F.
 Motors with Class F. Insulation - 140°F.
 Power Wiring - 140°F.
 Controls & Control Wiring - 140°F.
 Prefilters - 150°F.
 High Efficiency Filters - 200°F.
 Variable Speed Drives - ABB Mfg. - 140°F.
 Damper & Valve Actuators - 140° F.

STATIC PRESSURE LIMITS

- Maximum design cabinet pressure for YORK Solution units is ± 8 " W.C.
- Access doors are double wall. Doors provided with adjustable door latches and seals.

MOTORS



Do not operate fan motors in overload amperage condition.

Motor amperage should be checked again after the connecting ductwork is installed and an air balance performed on the air distribution system (*see Section 4 for Air Balancing Requirements*). ► If motor operates at amperage levels above nameplate, discontinue operation and correct cause, or *refer to Section 5.0, "Service and Repair"*. ►

BELTS

Belts should be checked for correct tension at startup and should be checked again after 24 hours of operation. On multiple belt adjustable pulleys, the pitch depth should be checked to insure identical belt travel, power transfer and wear. Adjustable motor bases are provided for belt adjustment. *See procedure in this section of the IOM.* ►

SHEAVES



If optional adjustable sheaves provided, we strongly recommend they be replaced with correctly sized fixed sheave immediately after system air balance is performed. It is not unusual for an adjustable sheave at some point in time to create damaging vibration in the fan assembly.

MAINTENANCE

INTRODUCTION

A planned program of regularly scheduled maintenance will return dividends by averting possible costly and unexpected periods of down time. It is the responsibility of the owner to provide the necessary maintenance for the air handling equipment and components.



Refer to Table 4-1 and ASHRAE Standard 62-2001 for Indoor Air Quality.

AIR HANDLER CABINET



Clean exterior with a mild, environmental safe detergent and high-pressure water (2000 PSI max.).

HARDWARE CHECK

Inspect doors, handles, latches and hinges for proper operation. Secure any loose parts (*see Section 5 for "Door Replacement" ► and "Door Handle/Latch Replacement" ► guides*).

GASKETS

Inspect door gaskets for damage and proper seal (*see Section 5 for "Door Gasket Replacement" guide*). ►

PANELS

Inspect panels for damage. If panels show signs of excessive pressure change, they will appear to bulge inward or outward.

See Troubleshooting Guide regarding excessive static pressure. ►

See Section 5 for "Panel Replacement" guide. ►

HOODS AND LOUVERS



Inspect air hoods and air louvers for damage and debris. Remove debris as needed.

BIRD SCREENS



Inspect bird screens for damage and debris. Remove debris as needed. Bird screens are an integral part of hoods and louvers.

MIST ELIMINATORS



Inspect mist eliminators for damage, dirt and debris. Mist eliminators are optional equipment. Mist eliminators in air hoods are removable for cleaning (see Section 5 for mist eliminator removal, cleaning and replacement).

CLEANING/REPLACEMENT

Cleaning or replacement (O.A. Hood) :

1. Remove clip(s) from leading edge of hood.
2. Remove Mist Eliminator or Cleanable Filter.
3. Clean with Eco friendly solution.
4. Install cleaner or new Mist Eliminator or Cleanable Filter.
5. Re-install the clips on the leading edge of the hood.

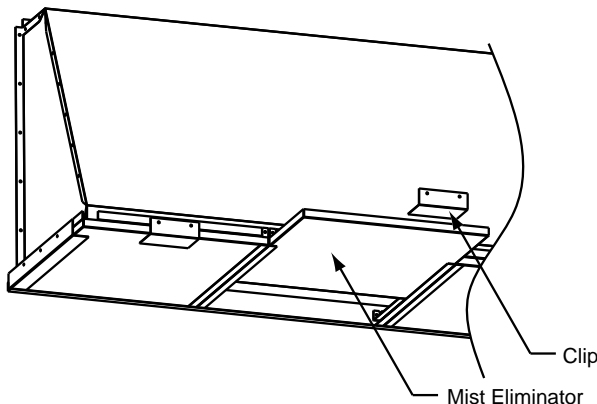
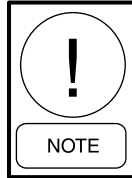


FIG. 4-1 – MIST ELIMINATOR REMOVAL

FAN SEGMENT (SUPPLY, RETURN, EXHAUST) - FAN ASSEMBLY



Fans can be removed for cleaning. Cleaning should be done using detergent or solvent that is environmentally safe. If water pressure is used, do not direct water stream onto bearing seals.



Forward Curved fan wheels are more susceptible to dirt accumulation than others. Dirt and debris on fan wheels and shafts may adversely affect the balance of the fan assembly.

See Section 5 for replacement guides regarding fan and fan assembly components. ►

- Check fan housing, wheel, shaft, frame and bearings: for damage, wear, loose parts, dirt and debris.
- Check fan base, vibration isolators and thrust restraints (optional) for damage, wear, loose parts, dirt and debris.
- Check flex connector for damage and wear. Make sure fan assembly does not rub flex material.
- Check Drive Kit - Drive kit consists of belts, sheaves and sheave bushings if required. Check for damage, loose parts, wear, dirt, alignment and belt tension.

(See Fig. 4-2, “Typical Drive Kit Data Tag” for example of data provided.) The unique/actual data required by design of each fan assembly is listed on the tag affixed to the fan housing near the belts.



FIG. 4-2 – TYPICAL DRIVE KIT DATA TAG

ADJUSTABLE MOTOR BASE OPERATION (Standard)

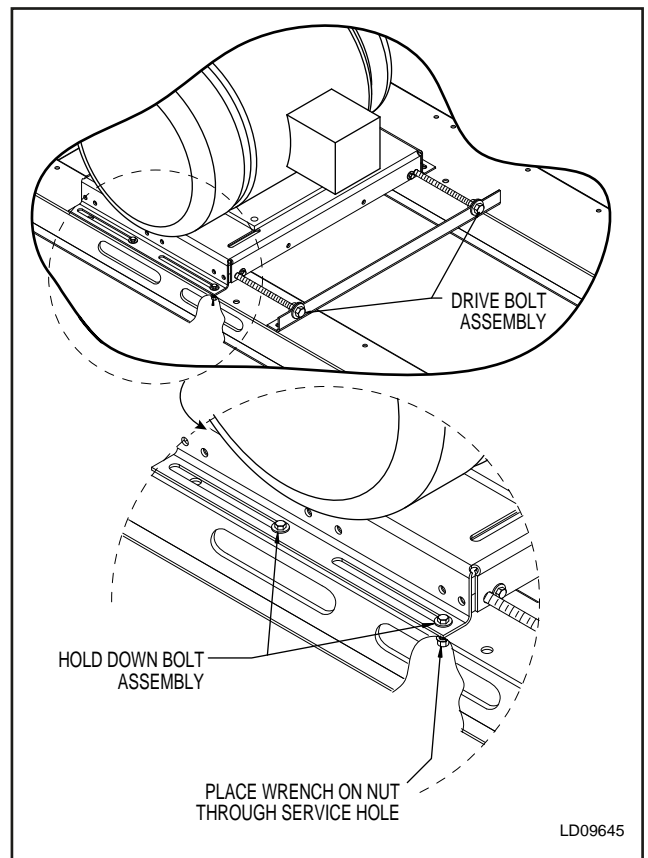
1. Secure the nut with a wrench placed through the service hole and loosen the bolt. Do this to all four Hold Down Bolt Assemblies (See Fig. 4-3).
2. Insure the Drive Bolt Assembly threads are lightly lubricated.
3. Turn both Drive Bolt Assemblies in the same direction to move motor for belt installation and tensioning.
4. Turn Drive Bolt Assemblies independently to move motor for sheave/belt alignment.
5. Tighten all four Hold Down Bolt Assemblies.

For belt tensioning instruction, see sub-topic “Belts” in this section. ►

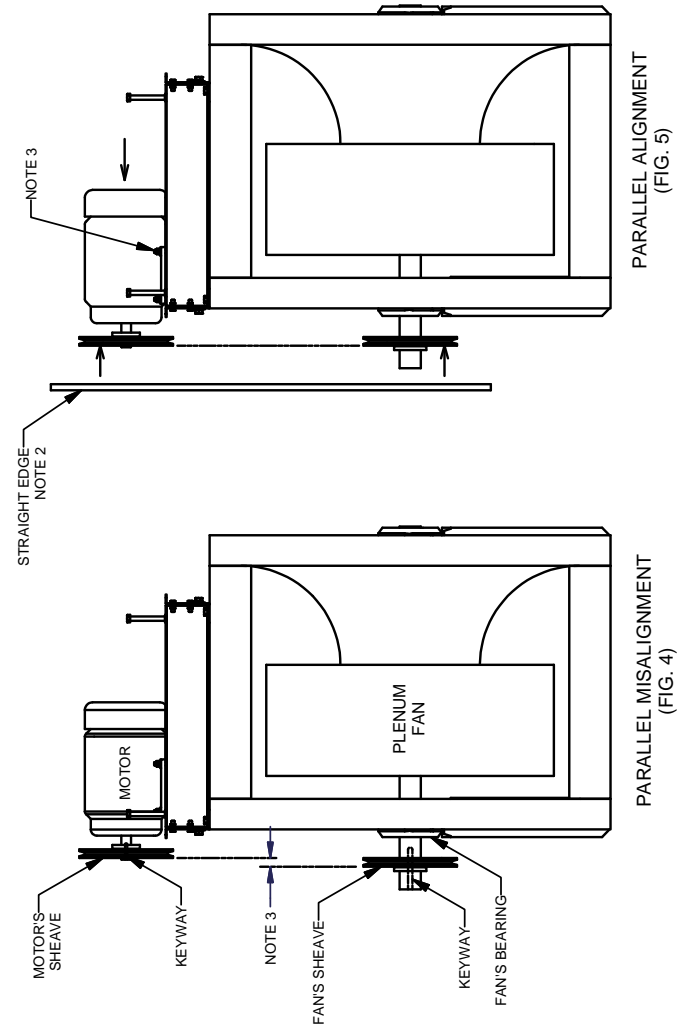
For alignment instruction, see sub-topic “Sheave Alignment” in this section. ►

ADJUSTABLE MOTOR BASE OPERATION (Top Mount)

See Fig.4-4 for procedure to adjust motor base.

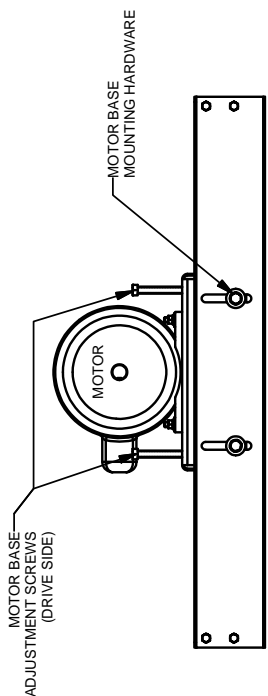


**FIG. 4-3 – ADJUSTABLE MOTOR BASE
(STANDARD)**

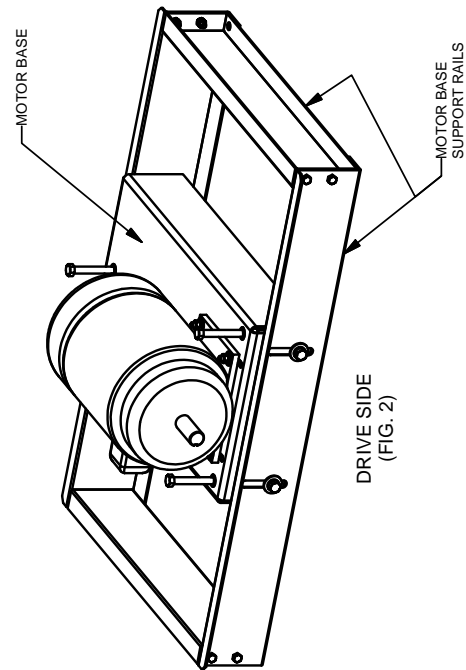


NOTES:

1. THE SHEAVES SHOULD BE CENTERED ON THE SHAFT'S KEYWAY. SHEAVE CAN BE CLOSER TO THE BEARING, AS LONG AS THE SHEAVES HUB IS ABLE TO FULLY ENGAGE WITH THE KEY.
2. CHECK FOR PARALLEL MISALIGNMENT BY PLACING A STRAIGHT EDGE ACROSS THE OUTER FACE OF THE SHEAVES (FIG. 5). STRAIGHT EDGE IS TO BE LONG ENOUGH THAT IT EXTENDS PAST BOTH SHEAVES.
3. IF THE SHEAVES ARE MISALIGNED (FIG. 4), LOOSEN THE MOTOR'S MOUNTING HARDWARE AND SLIDE THE MOTOR FORWARD (OR BACK) TO BRING THE SHEAVES INTO ALIGNMENT (FIG. 5), THEN RE-TIGHTEN HARDWARE.



DRIVE SIDE (FIG. 1)



DRIVE SIDE (FIG. 2)

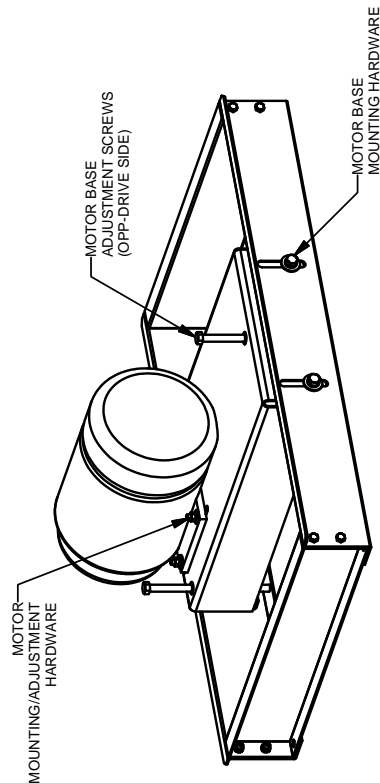
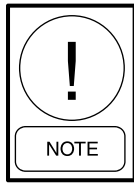


FIG. 4-4 – ADJUSTABLE MOTOR BASE (TOP MOUNT)

BELTS



Check belt tension. It is normal for belts to loosen after start up or replacement. The new belt will “run in” or “take a set” by seating slightly deeper into the grooves of the sheaves. Re-check tension after one day, and again after three days.

Check belt tension (see Fig. 4-5, “Belt Tensioning” and Fig. 4-6, “Belt Tensioning Gauge”).

1. Measure belt span (see Fig. 4-5).
2. Position bottom of the large “O” ring on the span scale at the measured belt span (see Fig. 4-6).
3. Set the small “O” ring on the deflection force scale to zero.
4. Place the tension gauge squarely on one belt at the center of the belt span. Apply a force on the plunger and perpendicular to the belt span until the bottom of the large “O” ring is even with the top of the next belt or with the bottom of a straight edge laid across the sheaves.
5. Remove the tension gauge and read the force applied from the bottom of the small “O” ring on the deflection force scale.
6. Compare the force you have applied with the value given on the Drive Kit Data Tag (see Fig. 4-2).

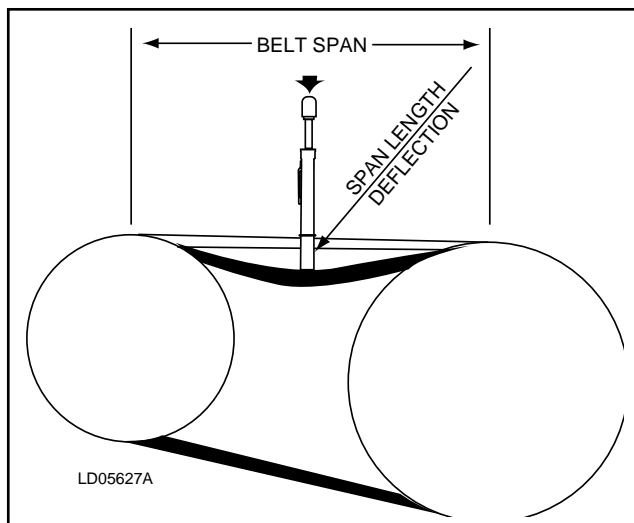


FIG. 4-5 – BELT TENSIONING



Never use excessive tension as this could result in damaging the bearing, motor pulleys or motor base. See drive label on fan housing adjacent to drive for specific details on tension. Squealing belts during starting is caused by slipping belts that are not tensioned properly.

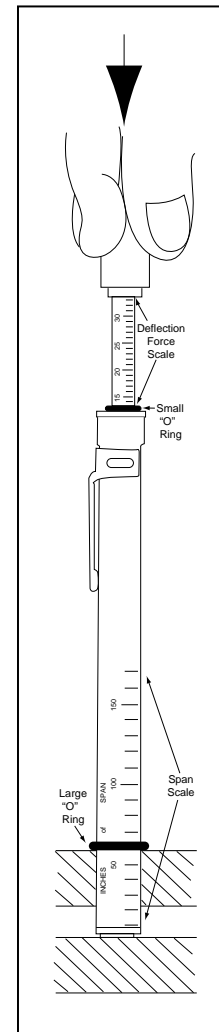


FIG. 4-6 – BELT TENSIONING GAUGE

SHEAVES ALIGNMENT



An incorrectly aligned sheave can substantially shorten belt life or overload blower and motor bearings, shortening their life expectancy. A belt tensioned too tightly can overload the motor electrically, causing nuisance tripping of the motor overloads and/or motor failure and/or shaft failure.

Sheave alignment and parallelism of shafts is very important. Proper alignment helps equalize the load across the entire belt width, thereby reducing wear and extending belt life. Fig. 4-7 shows how to align a synchronous drive properly using a straightedge (A) or a piece of string (B).

After aligning the sheaves, check the rigidity of the supporting framework. Shafts should be well supported to prevent distortion and a resulting change in the center distance under load. Do not use spring-loaded or weighted idlers.

ALIGNMENT USING A STRAIGHTEDGE

(Preferred)

Place a straightedge against the outer edge of the sheaves. Fig. 4-7(A) shows the four points where the straight edge should touch the sheaves. The straight edge should cross the sheaves at the widest possible part of the sheave.

ALIGNMENT USING A STRING

Tie a string around either shaft and pull it around and across the outer edge of both sheaves. Fig. 4-7(B) shows how the string should touch four points when the drive is properly aligned.

If alignment is other than described here, *see Section 5, "Sheave Replacement and Adjustment"*. ►

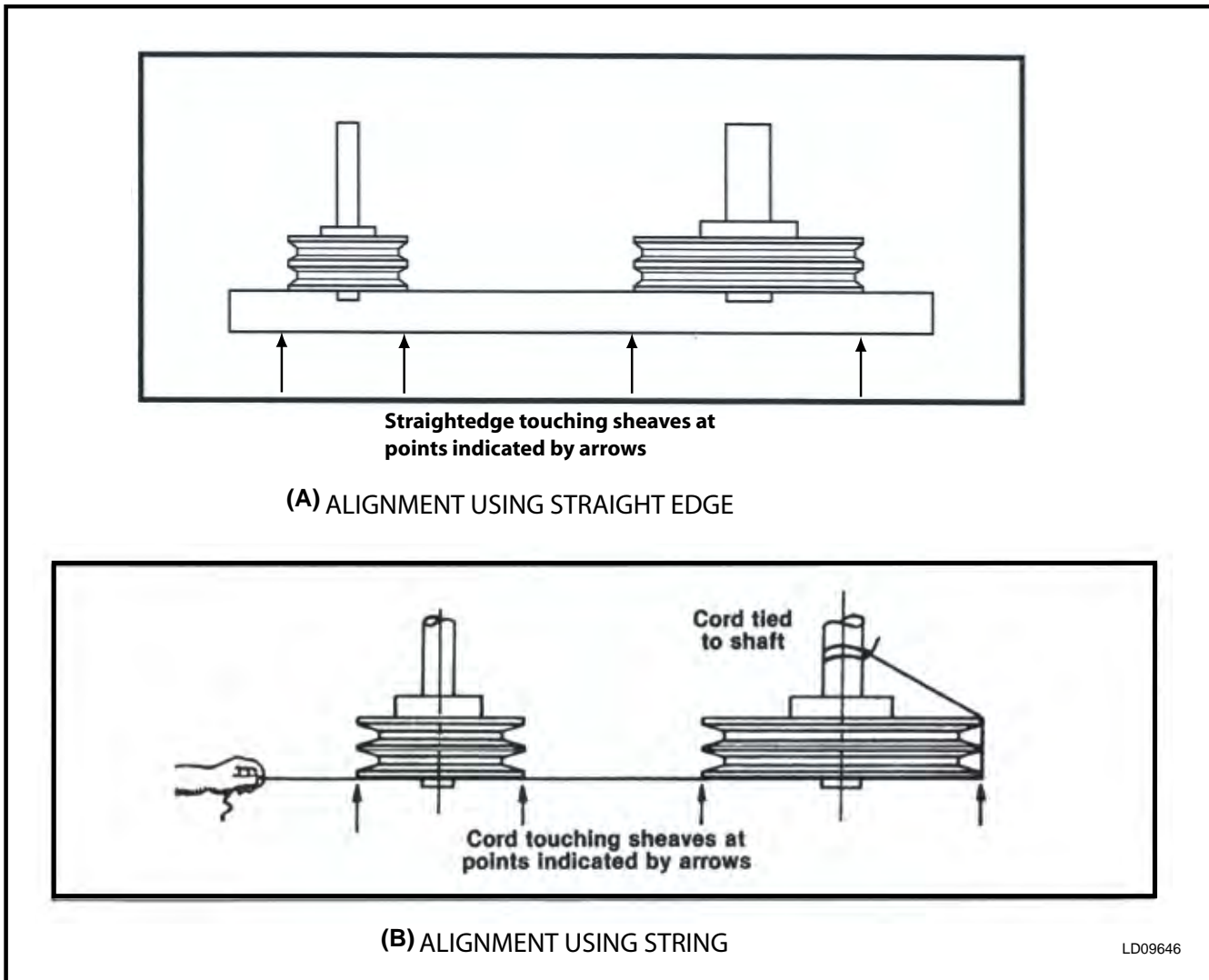
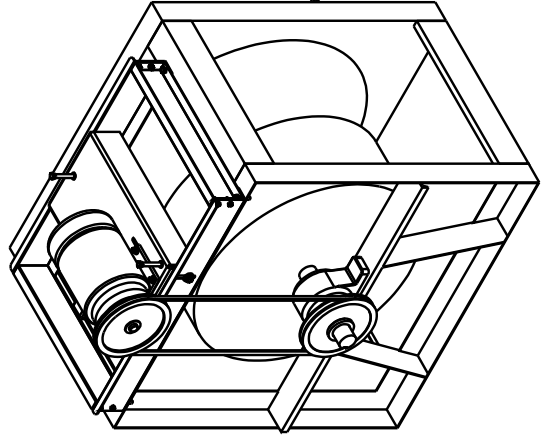
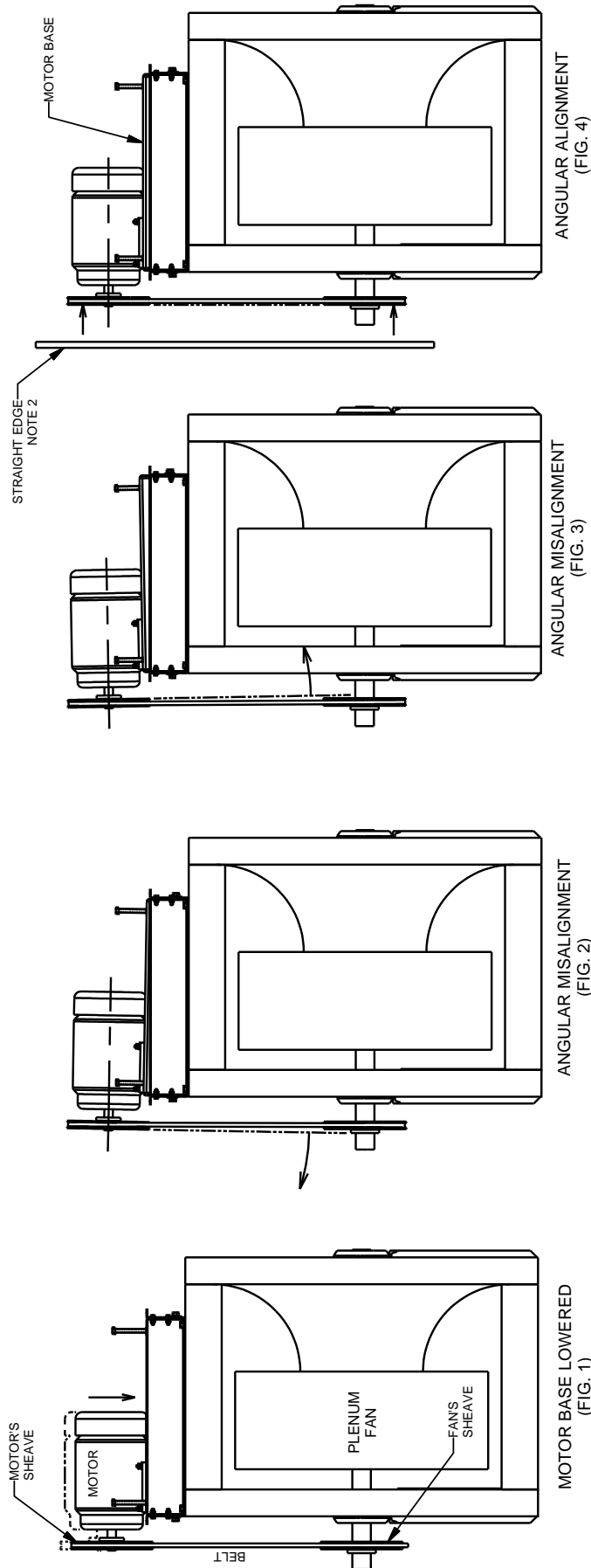


FIG. 4-7 – SHEAVE ALIGNMENT



- NOTES:**
1. TO REMOVE THE OLD BELT LOOSEN THE MOTOR BASE'S MOUNTING HARDWARE (DRIVE SIDE ONLY).
NOTE: THE DRIVE SIDE HAS 2 ADJ. SCREWS. TRY NOT TO INCREASE THE LEFT SIDE MORE THAN 1/2 ANCH BEFORE INCREASING THE RIGHT SIDE.
 2. LOWER DRIVE SIDE, USING THE ADJUSTMENT SCREWS (FIG. 3).
 3. ONCE THE TENSION HAS BEEN REMOVED FROM THE BELT, THE MOTOR BASE'S (OPP-DRIVE SIDE) MOUNTING HARDWARE CAN BE LOOSENED.
 4. CONTINUE LOWERING BOTH ENDS OF THE BASE UNTIL THE BELT(S) CAN BE REMOVED (FIG. 1).
 5. ONCE THE SHEAVES HAVE BEEN CHECKED FOR PARALLEL ALIGNMENT (SEE SHEET 1), THE NEW BELT(S) CAN BE PLACED ON THE SHEAVES.
 6. START RAISING THE BASE, TO TAKE THE SLACK OUT OF THE BELT(S), USING THE ADJUSTMENT SCREWS ON BOTH ENDS. USE 1/2 INCH INCREMENTS.
 7. AS THE BELT(S) START TO TIGHTEN, CHECK FOR PARALLEL MISALIGNMENT BY PLACING A STRAIGHT EDGE ACROSS THE OUTER FACE OF THE SHEAVES (FIG. 4). STRAIGHT EDGE IS TO BE LONG ENOUGH THAT IT EXTENDS PAST BOTH SHEAVES.
 8. IF THE SHEAVES ARE MISALIGNED AS SHOWN IN FIG. 2, THEN THE OPP-DRIVE SIDE NEEDS TO BE RAISED MORE.
 9. IF THE SHEAVES ARE MISALIGNED AS SHOWN IN FIG. 3, THEN THE DRIVE SIDE NEEDS TO BE RAISED MORE.
***WARNING: AS THEN TENSION ON THE BELT INCREASES, IT IS LIKELY THAT THE OPP-DRIVE SIDE OF THE BASE WILL LIFT UP. IT IS ADVISABLE THAT WHEN THE BELT STARTS TO GET TIGHT, THAT THE BASE'S OPP-DRIVE SIDE MOUNTING HARDWARE IS SECURED.
 10. CONTINUE TIGHTENING THE BELT(S) USING THE DRIVE SIDE ADJ. SCREWS ONLY.
 11. IF THE SHEAVES ARE STILL ALIGNED (FIG 4), AFTER REACHING THE BELT'S SPECIFIED TENSION, SECURE THE BASE'S DRIVE SIDE MOUNTING HARDWARE (YOU ARE FINISHED).
 12. IF THE SHEAVES ARE MISALIGNED (AS SHOWN IN FIG. 2 & 3), AFTER REACHING THE BELT(S) SPECIFIED TENSION, THEN LOWER THE DRIVE SIDE OF THE BASE (TO REMOVE BELT TENSION). LOOSEN THE BASE'S (OPP-DRIVE SIDE) MOUNTING HARDWARE AND RAISE OR LOWER ACCORDINGLY AND REPEAT STEPS 6 THROUGH 11.
- ***NOTE: YOU MAY WANT TO MARK THE POSITION OF THE BASE'S OPP-DRIVE SIDE MOUNTING HARDWARE, BEFORE LOWER THE BASE. THIS MAY HELP IN DETERMINING WHERE TO SECURE THE HARDWARE NEXT TIME AROUND.

FIG. 4-8 – BELT REPLACEMENT TENSIONING AND ALIGNMENT (TOP MOUNT)

LUBRICATION

VERIFY TYPES OF BEARINGS

Sealed (not to be re-lubricated in the field)

See Fig. 4-9



FIG. 4-9 – SEALED BEARING

Standard Pillow Block

See Fig. 4-10 & 4-11

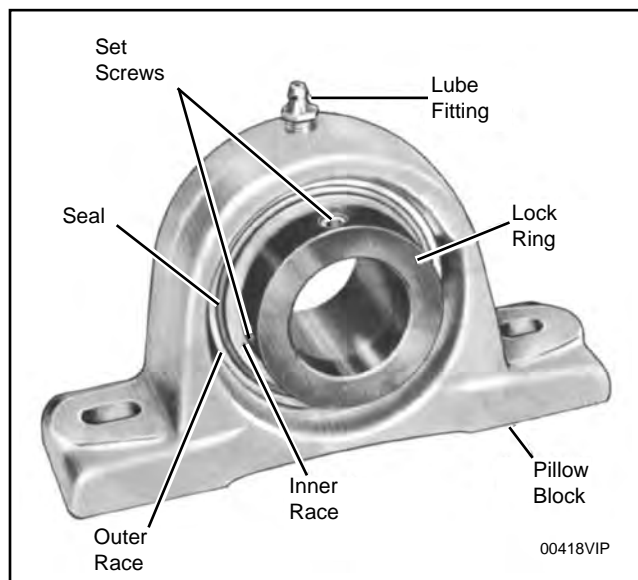


FIG. 4-10 – BEARING WITH SETSCREW TYPE LOCKING DEVICE

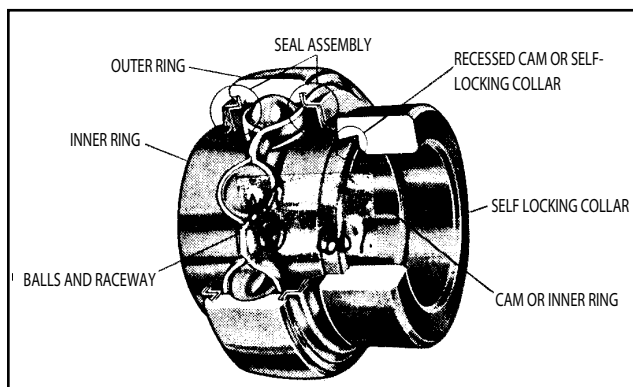


FIG. 4-11 – BEARING WITH ECCENTRIC CAM

Split Pillow Block

See Fig. 4-12

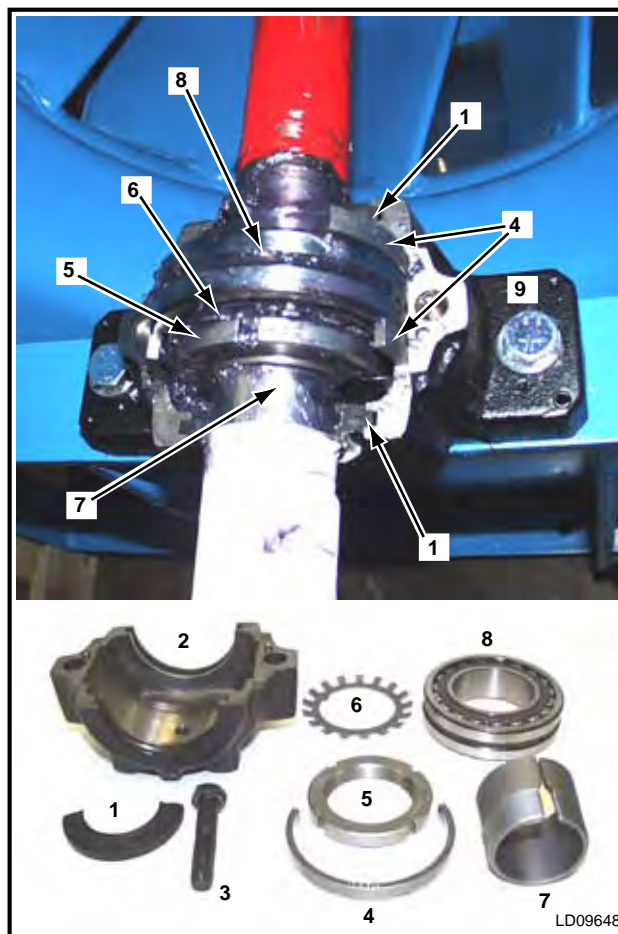


FIG. 4-12 – SPLIT BEARING

- 1. Seal (4)
- 2. Housing Cap
- 3. Cap Bolts (2)
- 4. Locating Ring (2)
- 5. Lock Nut
- 6. Lock Washer
- 7. Tapered Sleeve
- 8. Bearing
- 9. Housing Base

FAN BEARING LUBRICATION

See Tables 4-2, 4-3 & 4-4



If fans will be down four (4) weeks or more, properly apply correct grease and rotate monthly to prevent moisture from damaging bearings.

Fan bearings on the YORK Solution units are equipped with standard lubrication fittings. Units under 42" tall cabinet size will have either extended lube lines, enabling lubrication of both fan bearings from one side of fan (see Fig. 4-13) or optional external lube lines. For units of 42" tall cabinet size and above, extended lube lines and external lube lines are optional. Some fans will have permanently lubricated bearings.

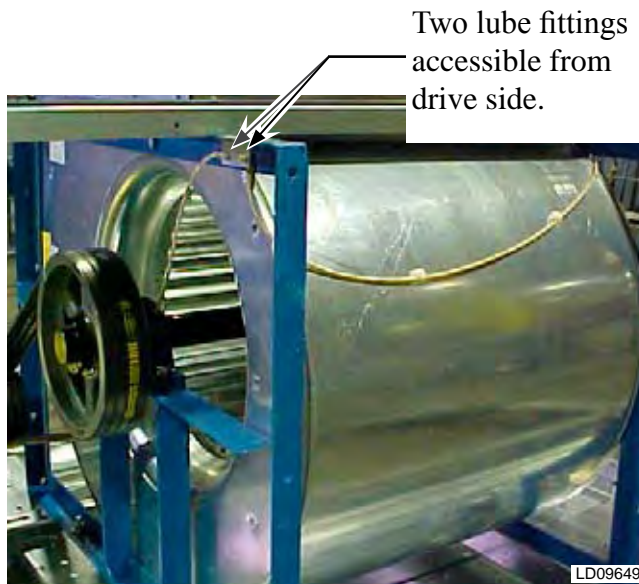
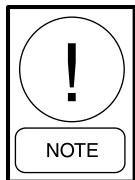


FIG. 4-13 – LUBRICATION LINES (OPTIONAL)



For specific fan bearing lubrication, check the instruction packet attached to the fan housing. Some forward curved fans are permanently lubricated.

For best results, standard pillow block bearings should be re-lubricated while in operation providing personal safety is assured. Add grease slowly with shaft rotating until a slight bead forms at the seals.

If necessary to re-lubricate while bearing is stationary, refer to manufacturer's data for maximum grease capacity for the size bearing.

Re-lubrication is generally accompanied by a temporary rise in operating temperature. Excess grease will be purged at seals. Always wipe away purged grease after several hours of operation.

CHECK CONDITION OF EXTENDED LUBRICATION LINES WHEN PRESENT

See Fig. 4-13

Check lube lines for:

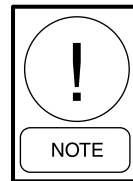
- Cracks and brittleness (replace as needed).
- Fittings tight and lube lines tight on fittings.
- Air bubbles in grease (disconnect and purge as necessary).

RECOMMENDED LUBRICANT FOR FAN BEARINGS

A Lithium / Petroleum base grease conforming to an NLGI Grade II consistency is normally used. Lubricant must be free of any chemical impurities such as free acid or free alkali, dust, rust, metal particles or abrasives. This light viscosity, low torque grease is rust inhibited and water resistant, has a temperature range of -30°F to +200°F with intermittent highs of +250°F. Lubricate bearings as required by the severity of required duty.

PROPER INTERVAL AND QUANTITY

See Tables 4-2, 4-3 & 4-4



Bearing on fan split pillow blocks is 1/3 full when only one side of bearing is completely full of grease.

| TABLE 4-2 – FAN BEARING – LUBRICATION INTERVALS - BALL BEARING PILLOW BLOCKS | | | | | | | | | |
|--|-----|------|------|------|------|------|------|------|------|
| Re-lubrication schedule (months) | | | | | | | | | |
| SPEED (RPM) | 500 | 1000 | 1500 | 2000 | 2500 | 3000 | 3500 | 4000 | 4500 |
| SHAFT DIA. | | | | | | | | | |
| 1/2" THRU 1-11/16" | 6 | 6 | 5 | 3 | 3 | 2 | 2 | 2 | 1 |
| 1-15/16" THRU 2-7/16" | 6 | 5 | 4 | 2 | 2 | 1 | 1 | 1 | 1 |
| 2-11/16" THRU 2-15/16" | 5 | 4 | 3 | 2 | 1 | 1 | 1 | | |
| 3-7/16" THRU 3-15/16" | 4 | 3 | 2 | 1 | 1 | 1 | | | |

| TABLE 4-3 – FAN BEARING – LUBRICATION INTERVALS - SPHERICAL ROLLER BEARING SOLID PILLOW BLOCKS | | | | | | | | | |
|--|-----|------|------|------|------|------|------|------|------|
| Re-lubrication schedule (months) | | | | | | | | | |
| SPEED (RPM) | 500 | 1000 | 1500 | 2000 | 2500 | 3000 | 3500 | 4000 | 4500 |
| SHAFT DIA | | | | | | | | | |
| 1-3/16" THRU 1-7/16" | 6 | 4 | 4 | 2 | 1 | 1 | 1 | 1 | ½ |
| 1-11/16" THRU 2-3/16" | 4 | 2 | 1½ | 1 | ½ | ½ | ½ | ½ | ½ |
| 2-7/16" THRU 3-7/16" | 3 | 1½ | 1 | ½ | ½ | ½ | ½ | | |
| 3-15/16" THRU 4-15/16" | 2½ | 1 | ½ | ¼ | | | | | |

| TABLE 4-4 – FAN BEARING – LUBRICATION INTERVALS - SPHERICAL ROLLER BEARING-SPLIT PILLOW BLOCKS | | | | | | | | | | Grease to be added at each interval |
|--|-----|-----|------|------|------|------|------|------|------|-------------------------------------|
| Re-lubrication schedule (months) | | | | | | | | | | |
| SPEED (RPM) | 500 | 750 | 1000 | 1500 | 2000 | 2500 | 3000 | 3500 | 4000 | |
| SHAFT DIA | | | | | | | | | | |
| 1-7/16" THRU 1-15/16" | 6 | 4½ | 4 | 4 | 3½ | 2½ | 2½ | 1 | 1 | 0.50 OZ. |
| 2-3/16" THRU 2-11/16" | 5 | 4½ | 4 | 2½ | 2½ | 1½ | ½ | ¼ | ¼ | 0.75 OZ. |
| 2-15/16" THRU 3-15/16" | 4½ | 4 | 3½ | 2½ | 1½ | 1 | ½ | | | 2.00 OZ. |
| 4-7/16" THRU 4-15/16" | 4 | 4 | 2½ | 1 | ½ | | | | | 4.00 OZ. |
| 5-7/16" THRU 5-15/16" | 4 | 2½ | 1½ | 1 | | | | | | 7.00 OZ. |

FAN SEGMENT-FAN MOTOR

See Section 5 “Fan Replacement & Adjustment” for motor replacement guide. ►

Keep the motor clean, dry and properly lubricated at all times. On ODP (Open Drip Proof) type motors, blow dust and dirt out of windings periodically using low-pressure (50 PSIG) air.

Mounting Hardware and Adjustable Motor Base
See Section 4 for motor base replacement and adjustment guide. ►

- Check for loose parts.
- Check for damage.

MOTOR CONDITION (VISUAL)

- Check for leaky bearing seals.
- Check for damage.
- Check for dirt, dust & debris in air vents on motor housing.

ELECTRICAL CHECKS

- Check all electrical terminations.
- Check conduit fittings and clamps for damage or looseness.
- Check operating amperage and compare to nameplate.



LD09635

FIG. 4-14 – ODP (OPEN DRIP PROOF)



LD09639

FIG. 4-15 – TEFC (TOTALLY ENCLOSED FAN COOLED)

LUBRICATION

MOTOR BEARING LUBRICANT

Bearing grease will lose its lubricating ability over time, not suddenly. The lubricating ability of grease (over time) depends primarily on the type of grease, the size of the bearing, the speed at which the bearing operates and the severity of the operating conditions. Good results can be obtained if the following recommendations are used in your maintenance program:

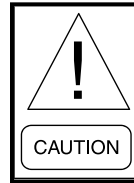
- A high-grade ball or roller bearing grease should be used. Recommended grease for standard service conditions is Polyrex EM (Exxon Mobil).
 - Maximum operating temperature for standard motors = 110°C/166°F.

- Shutdown temperature in case of a malfunction = 115°C/175°F.

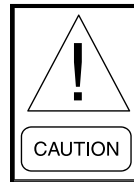
• Proper Interval

Lubrication Intervals – Recommended lubrication intervals are shown in Table 4-5. It is important to realize that the recommended intervals of Table 4-5 are based on average use. *Refer to additional information contained in Tables 4-6 & 4-7.*

• Motor Lubrication Procedure



Be sure that the grease you are adding to the motor is compatible with the grease already in the motor. Consult your distributor or an authorized service center if grease other than the recommended type is to be used.



To avoid damage to motor bearings, grease must be kept free of dirt. For an extremely dirty environment, contact your distributor or an authorized service center for additional information.

– With Grease Relief Plug

1. Clean all grease fittings.
2. Remove grease relief plug.
3. If motor is stopped, add the recommended amount of grease.
4. If motor is to be greased while running, a slightly greater quantity of grease will have to be added. Add grease slowly until new grease appears at shaft hole in the end plate or relief plug hole.
5. Clean off any grease from the grease fitting.
6. Run motor for 15 to 30 minutes with relief plug out to warm up the grease.
7. Wipe off any grease that pushed out of the relief plug.
8. Re-install grease relief plug.

| TABLE 4-5 – MOTOR BEARING – LUBRICATION INTERVALS | | | | | | |
|--|--------------------------|-------------|-------------|-------------|-------------|--------------|
| NEMA / (IEC) FRAM SIZE | RATED SPEED - RPM | | | | | |
| | 10000 | 6000 | 3600 | 1800 | 1200 | 900 |
| UP TO 210 INCL. (132) | ** | 2700 HRS. | 5500 HRS. | 12000 HRS. | 18000 HRS. | 22000 HRS.. |
| OVER 210 TO 280 INCL. (180) | | | 3600 HRS. | 9500 HRS.. | 15000 HRS. | 18000 HRS... |
| OVER 280 TO 360 INCL. (180) | | | *2200 HRS. | 7400 HRS.. | 12000 HRS. | 15000 HRS. |
| OVER 360 TO 5800 INCL. (180) | | | *2200 HRS.. | 3500 HRS.. | 7400 HRS.. | 10500 HRS. |

* Lubrication intervals are for ball bearings. For roller bearings, divide the listed lubrication interval by 2.
 ** For 6205 and 6806 bearings. For 6807 bearings, consult oil mist lubrication (MN410).
 Re lubrication interval for 6205 bearing is 1550 HRS. (Using grease lubrication).
 Re lubrication interval for 6806 bearing is 720 HRS. (Using grease lubrication).

| TABLE 4-6 – MOTOR BEARING – SERVICE CONDITIONS | | | |
|---|--|--------------------------------------|-----------------------------|
| SEVERITY OF SERVICE | AMBIENT TEMPERATURE MAXIMUM | ATMOSPHERIC CONTAMINATION | TYPE OF BEARING |
| STANDARD | 40°C | CLEAN, LITTLE CORROSION | DEEP GROOVE BALL BEARING |
| SEVERE | 50°C | MODERATE DIRT, CORROSION | BALL THRUST, ROLLER |
| EXTREME | >50°C* OR CLASS H INSULATION | SEVERE DIRT, ABRASIVE DUST | ALL BEARINGS |
| LOW TEMPERATURE | <-30°C** | CORROSION | |

* Special high temperature grease is recommended. Note that high temperature grease may not mix with other grease types. Thoroughly clean bearing and cavity before adding grease.
 ** Special low temperature grease is recommended.

| TABLE 4-7 – MOTOR BEARING – LUBRICATION INTERVAL MULTIPLIER | |
|--|-------------------|
| SEVERITY OF SERVICE | MULTIPLIER |
| STANDARD | 1.0 |
| SEVERE | 0.5 |
| EXTREME | 0.1 |
| LOW TEMPERATURE | 1.0 |

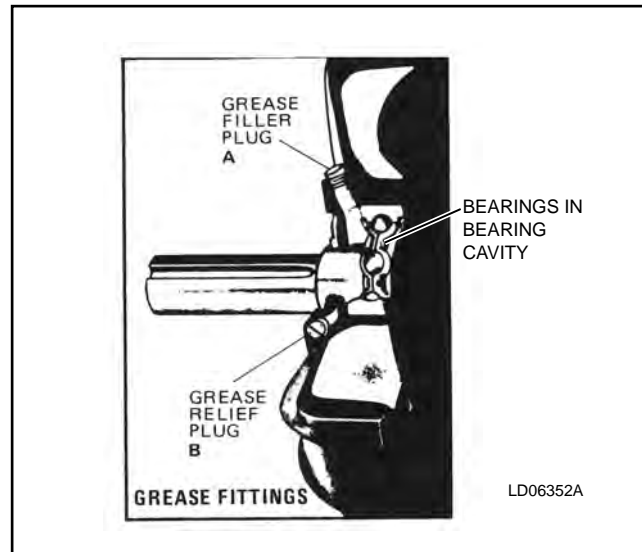
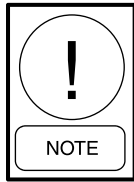
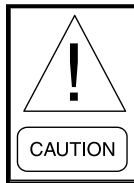


FIG. 4-16 – GREASE FITTINGS

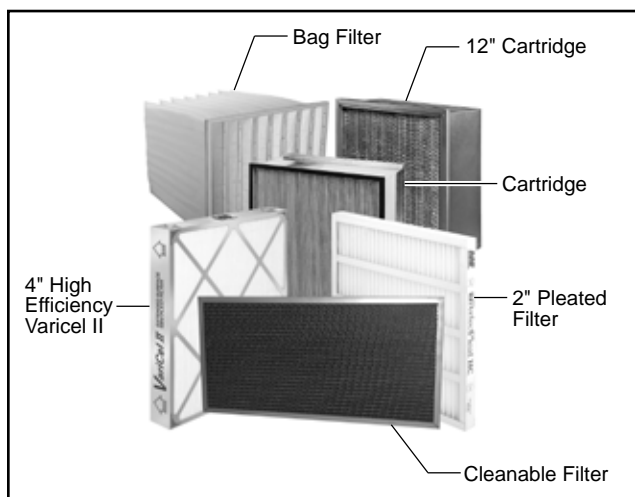
FILTER SEGMENTS (PRE FILTER AND FINAL FILTER)



A list of filter part numbers, sizes and quantities are shown on a label located on each filter segment of each air handler.



If your unit has HEPA filters the filter frames, filter bulkheads and filter segment panels are factory sealed and must remain sealed for NO air bypass.



LD09650

FIG. 4-17 – TYPICAL FILTERS

FILTER TYPES

Flat, angle, rigid, bag, HEPA & charcoal.

MAINTENANCE AND REPLACEMENT

Every month, check the cleanliness of the filters and replace. Filters should be replaced when the pressure drop, measured by a manometer, reaches the prescribed limits for the installation.

INSERTING FILTERS INTO SIDE LOAD FILTER TRACKS FOR ANGLE AND FLAT FILTER SEGMENTS.

1. Check filter sizes and quantities. *See filter label located on each filter segment.*
2. Remove filter frame end cover (see Fig's 4-18 and 4-16).
3. Remove old filters if present.
4. Make sure gaskets at both ends of Side Load filter tracks are in place. The gaskets are normally found on inside of filter frame end covers.
5. Slide the correct size new filters into tracks.
6. On bag filters (in FF segments) leave banding in place until filters are installed; then remove. Install bag filters so that pocket dividers are vertical if filters are over 12" high.
7. Airflow arrows must point downstream (in direction of airflow).
8. All pleated filters must be installed with pleats vertical.
9. Re-install filter frame end cover.

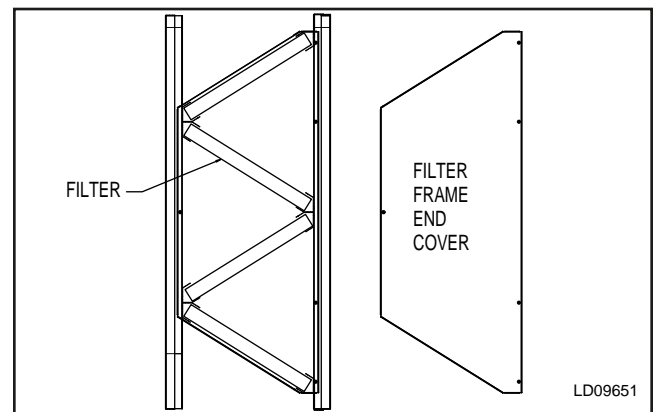


FIG. 4-18 – ANGLE FILTER INSTALLATION.

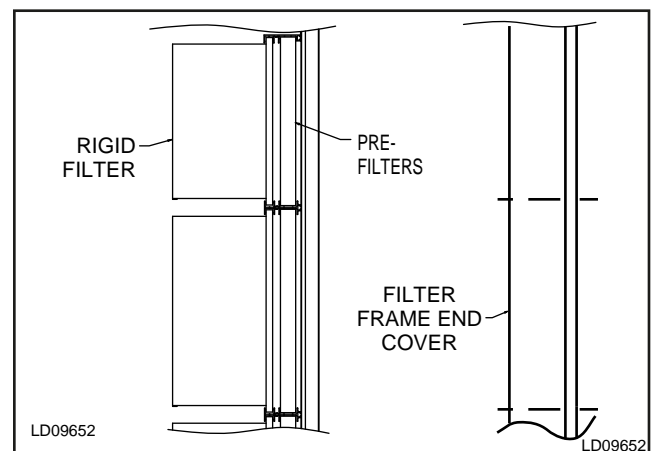


FIG. 4-19 – SIDE LOAD FILTER INSTALLATION.

FILTER LATCHES

NOTE: Typically when filters are by others, so are the filter clips.



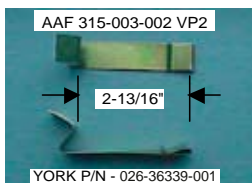
Used with 2" Perfectpleat, Premium or Premium HM and SH Single Headered Filters.



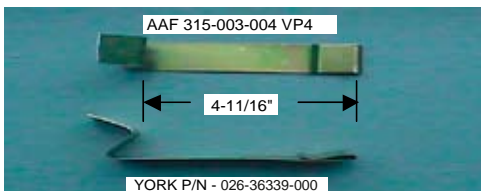
Used with 2" (C86) & 4" (C89)" Amair 300 X Pleated Prefilter in combination with a Single Header Final Filter.



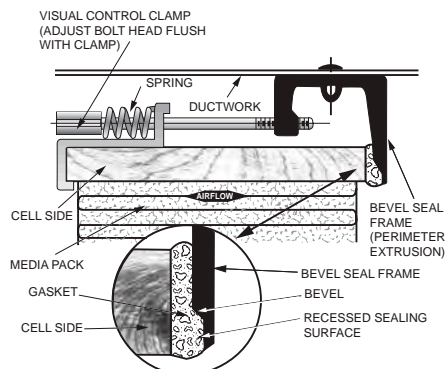
Used with 2" & 4" Prefilter in combination with a Double Header Final Filter.



Used with 2" Prefilter in combination with a Double Header Final Filter.



Used with 4" Prefilter in combination with a Double Header Final Filter.



Used to attach HEPA Filters to Holding Frame.

LD13303A

FIG. 4-20 – FILTER LATCHES

YORK MATRIX: AAF FILTERS AND AAF FRAMES / LATCHES

| Single Filter Application | | | | |
|--|---|----------------------|--|-------------------|
| | 2" AAF PerfectPleat, Premium or Premium HM | 4" AAF AmAir 300X | AAF VariCel SH or AAF DriPak 2000 | AAF VariCel DH |
| AAF FRAME - 312-300-000 12x24 - 16 ga. Galvanized | | | | |
| AAF 315-004-003 (C70) YORK 026-35778-000 | X | | X | |
| AAF 315-004-000 (C86) YORK 026-35778-007 | | X | | |
| AAF 315-004-001 (C80) YORK 026-35778-006 | | | | X |
| AAF FRAME - 312-300-006 24X24 - 16 ga. Galvanized | | | | |
| AAF 315-004-003 (C70) YORK 026-35778-000 | X | | X | |
| AAF 315-004-000 (C86) YORK 026-35778-007 | | X | | |
| AAF 315-004-001 (C80) YORK 026-35778-006 | | | | X |

| Prefilter / Final Filter Application | | | | |
|---|---|---|---|---|
| | AAF PerfectPleat, Premium or HM <u>AND</u> AAF Varicel SH or DriPak 2000 | AAF PerfectPleat, Premium or HM <u>AND</u> AAF Varicel DH | AAF 4" AmAir 300X <u>AND</u> VariCel SH or DriPak 2000 | AAF 4" AmAir 300X <u>AND</u> VariCel DH |
| AAF FRAME - 312-300-000 12x24 - 16 ga. Galvanized | | | | |
| AAF 315-004-000 (C86) YORK 026-35778-007 & AAF 315-004-003 (C70) YORK 026-35778-000 | X | | | |
| AAF 315-004-001 (C80) YORK 026-35778-006 & AAF 315-003-002 VP2 - YORK 026-36339-001 | | X | | |
| AAF 315-004-000 (C86 & C89) YORK 026-35778-007 & 026-35778-008 & AAF 315-004-003 (C70) YORK 026-35778-000 | | | X | |
| AAF 315-004-001 (C80) YORK 026-35778-006 & AAF 315-003-004 VP4 - YORK 026-36339-000 | | | | X |
| AAF FRAME - 312-300-006 24X24 - 16 ga. Galvanized | | | | |
| AAF 315-004-000 (C86) YORK 026-35778-007 & AAF 315-004-003 (C70) YORK 026-35778-000 | X | | | |
| AAF 315-004-001 (C80) YORK 026-35778-006 & AAF 315-003-002 VP2 - YORK 026-36339-001 | | X | | |
| AAF 315-004-000 (C86 & C89) YORK 026-35778-007 & 026-35778-008 & AAF 315-004-003 (C70) YORK 026-35778-000 | | | X | |
| AAF 315-004-001 (C80) YORK 026-35778-006 & AAF 315-003-004 VP4 YORK 026-36339-000 | | | | X |

NOTE: Typically when filters are by others, so are the filter clips.

INSTALLATION OF 2" PERFECTPLEAT, PREMIUM OR PREMIUM HM

These instructions are for installing a 2" filter (typically AAF PerfectPleat) into AAF 16 ga. galvanized holding frames.

- Latches needed for these applications are four (4) AAF P/N 315-004-003, as shown in Fig. 4-20.
- A single latch should be installed at each of the four (4) corners of the frame.
- The latch fits into the set of knockouts, which consists of two (2) rows of three (3) knockouts. The row of knockouts closest to the gasketing should be used for nominal 1" filters or filters with a 13/16" single header. The second set of knockouts should be used for nominal 2" filters.

Installation of Spring Latches

1. Insert the straight end of the latch between the two (2) knockouts furthest from the corner.
2. Using a moderate amount of pressure, force the latch over the third knockout.
3. The latch installation should now be complete. The latch should now be "trapped" within the three (3) knockouts, but should be able to freely rotate (see Fig. 4-21).

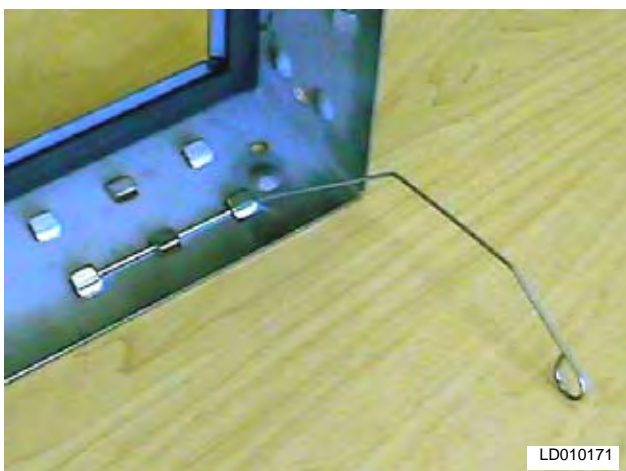


FIG. 4-21 – CORRECTLY INSTALLED LATCH P/N 315-004-003.

Repeat the installation process with the remaining latches in the other three corners.

4. Rotate all of the latches outward, and insert the filter into the frame.
5. After the filter has been placed into the frame, grasp the circular end of the latch and rotate it across the corner of the filter.

Push the end of the latch towards the filter, until the latch catches beneath the knockout on the frame.

Repeat for the remaining latches.

6. The filter should now be securely installed into the frame (see Fig 4-22).

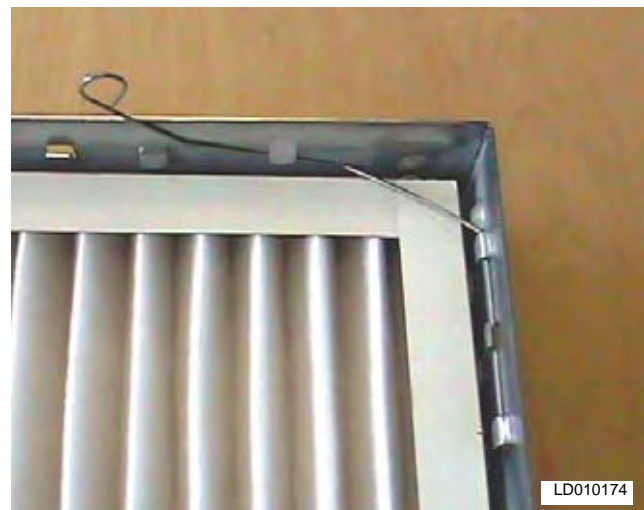


FIG. 4-22 – FULLY INSTALLED FILTER

INSTALLATION OF 4" AMAIR 300X PLEATED FILTER

These instructions are for installing a four (4)" filter (typically AAF AmAir 300X pleated filter) into AAF 16 ga. galvanized holding frames.

- Latches needed for these applications are four (4) AAF P/N 315-004-000, as shown in Fig 4-20.
- A single latch should be installed at each of the four (4) corners of the frame.
- The latch fits into the set of knockouts, which consists of two (2) rows of three (3) knockouts. The row of knockouts closest to the gasketing should be used for filters with a 13/16" single header in combination with a nominal 2" prefilter. The second set of knockouts should be used for nominal 4" filters.

Installation of Spring Latches

1. Insert the straight end of the latch between the two (2) knockouts furthest from the corner.
2. Using a moderate amount of pressure, force the latch over the third knockout.
3. The latch installation is now complete. The latch should now be "trapped" within the three (3) knockouts (see Fig. 4-23).



FIG. 4-23 – CORRECTLY INSTALLED LATCH P/N 315-004-000

Repeat the installation process with the remaining latches.

4. Insert the filter into the frame.
5. After the filter has been placed into the frame, grasp the loose end of the latch and place it over the filter frame, so that the latch secures the filter into the frame (see Fig. 4-24).

Repeat for the remaining latches.



FIG. 4-24 – PLACE THE END OF THE LATCH OVER THE FILTER FRAME, SECURING THE FILTER TO THE FRAME.

6. The filter should now be securely installed into the frame.

INSTALLATION OF SH SINGLE HEADERED FILTERS

These instructions are for installing single header filter (typically AAF VariCel SH or DriPak 2000 filter) into AAF 16 ga. galvanized holding frames

- Latches needed for these applications are four (4) AAF P/N 315-004-003, as shown in Fig. 4--20.
- A single latch should be installed at each of the four (4) corners of the frame.
- The latch fits into the set of knockouts, which consists of two (2) rows of three (3) knockouts. The row of knockouts closest to the gasketing should be used for nominal 1" filters or filters with a 13/16" single header. The second set of knockouts should be used for nominal 2" filters.

Installation of Latches

1. Insert the straight end of the latch between the two (2) knockouts furthest from the corner.
2. Using a moderate amount of pressure, force the latch over the third knockout.
3. The latch installation should now be complete. The latch should now be "trapped" within the three (3) knockouts, but should be able to freely rotate.

Repeat the installation process with the remaining latches.

4. Rotate all of the latches outward, and insert the SH filter into the frame. The bulk of the filter should be inserted through the frame, protruding out the backside. Only the header of the filter should be contacting the flange of the frame.
5. After the filter has been placed into the frame, grasp the circular end of the latch and rotate it across the corner of the filter.

Push the end of the latch towards the filter, until the latch catches beneath the knockout on the frame.

Repeat for the remaining latches.

6. The filter should now be securely installed into the frame (see Fig. 4-25).

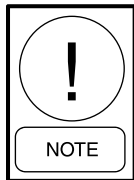


FIG. 4-25 – FULLY INSTALLED FILTER

INSTALLATION OF A 2" PREFILTER IN COMBINATION WITH A SINGLE HEADER FINAL FILTER

These instructions are for installing a 2" prefilter, (typically AAF PerfectPleat, Premium or Premium HM pleated filter) used in combination with a single header final filter (typically AAF VariCel SH or DriPak 2000) into AAF 16 ga. galvanized holding frames.

- Latches needed for this application are four (4) AAF P/N 315-004-000 and four (4) 315-004-003 as shown in Fig. 4-20.



Follow instructions for Single Headered (SH) filters then proceed with this procedure for 2" Pre-filters.

Installation of Latches

1. Insert the straight end of the latch (P/N 315-004-000) between the two (2) knockouts furthest from the corner.



FIG. 4-26 – INSTALL LATCH P//N 315-004-000

2. Using a moderate amount of pressure, force the latch over the third knockout (*See Fig. 4-21*).

After both filters have been placed into the frame, grasp the loose end of the latch and place it over the prefilter frame, so that the latch secures the prefilter to the SH filter. Repeat for the remaining latches.

4. The filters should now be securely installed into the frame, as shown in Fig. 4-27.



FIG. 4-27 – FULLY INSTALLED FILTERS

INSTALLATION OF A VARICEL DH DOUBLE HEADERED FILTER

These instructions are for the installation of an AAF VariCel DH filter (nominal 12" deep double header) into AAF 16 ga. galvanized holding frames.

- The latches needed for this application are four (4) spring latches, AAF P/N 315-004-001 (as shown in Fig. 4-20).
- Two latches should be attached on each side of the filter frame.
- The latches should only be installed, two (2) per side of the frame. There should be no latches used on the top or bottom. This is done to match the holes in the filter frame, used to secure the latch to the filter. See Fig. 4-28 for the sets of knockouts that should be used for the latches.

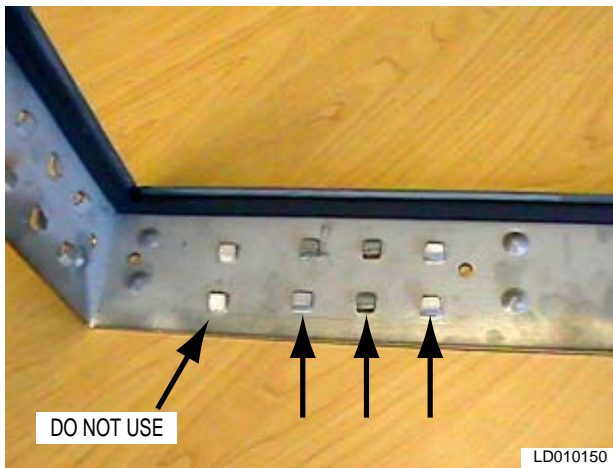


FIG. 4-28 – CORRECT USE OF KNOCKOUTS

Installation of Spring Latches

1. Insert the straight end of the latch between the knockouts furthest from the corner.
2. Using a moderate amount of pressure, force the latch over the third knockout.
3. The latch installation should now be complete. The latch should now be “trapped” within the three (3) knockouts.

4. Repeat the latch installation with the remaining latches. *Note the orientation of the latch to the knockouts in Fig. 4-29.*

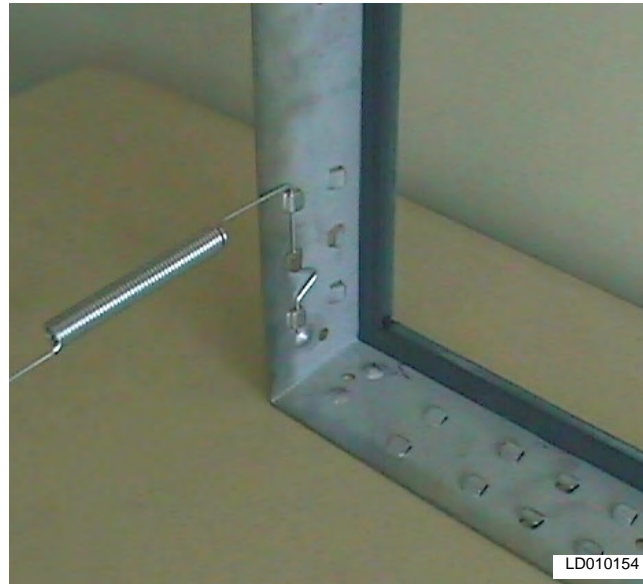


FIG. 4-29 – CORRECT LATCH/KNOCKOUT CONFIGURATION.

After the latches have been installed, the frame should be configured like that shown in Fig. 4-30.

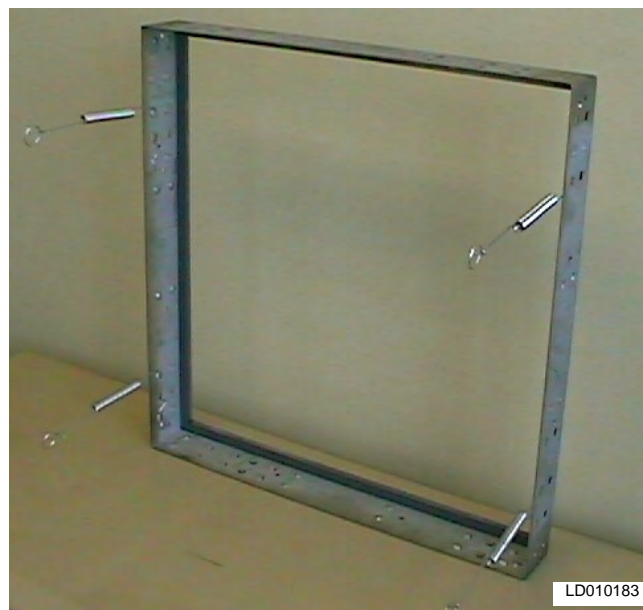
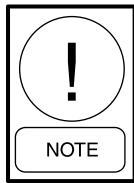


FIG. 4-30 – FRAME WITH 4 LATCHES INSTALLED.



The frame contains 2 latches per side, none on the top or bottom.

5. Insert the VariCel DH filter into the frame. While holding the filter in the frame, grasp the loop on the end of the latch and pull it until it stretches over the header and rests into the pre-drilled hole in the header of the filter (*see Fig. 4-31*). Repeat this with the remaining latches.
6. The filter should now be securely installed into the frame.



FIG. 4-31 – SPRING LATCH SHOULD BE PULLED AND FASTENED IN HOLE IN THE HEADER OF THE FILTER.

INSTALLATION OF A 2" & 4" PREFILTER IN COMBINATION WITH A DOUBLE HEADER FINAL FILTER

These instructions are for installing either a 2" or 4" prefilter (typically AAF PerfectPleat, Premium or Premium HM pleated filters) used in combination with an AAF VariCel DH (nominal 12" deep) final filter into AAF 16 ga. galvanized holding frames.

- Two sets of latches are needed for these applications. Four (4) spring latches, AAF P/N 315-004-001 are used to hold the VariCel DH into the frame. In addition, four (4) prefilter latches, AAF P/N 315-003-002 are used to hold the 2" and P/N 315-003-004 are used to hold the 4" prefilter onto the face of the VariCel DH filter.
- For the spring latches, two (2) latches should be attached on each side of the filter frame.
- The latches should only be installed, two (2) per side of the frame. There should be no latches used on the top or bottom. This is done to match the holes in the filter frame, used to secure the latch to the filter.

Installation of Spring Latches

1. Insert the straight end of the latch between the knockouts furthest from the corner.
2. Using a moderate amount of pressure, force the latch over the third knockout.
3. The latch installation should now be complete. The latch should now be "trapped" within the 3 knockouts (*see Fig. 4-32*).



FIG. 4-32 – CORRECT LATCH/KNOCKOUT CONFIGURATION. P/N 315-004-001

4. Repeat the latch installation with the remaining latches; *note the orientation of the latch to the knockouts on Fig. 4-32.*
5. Insert the VariCel DH filter into the frame. While holding the filter in the frame, grasp the loop on the end of the latch and pull it until it stretches over the header and rests into the pre-drilled hole in the header of the filter (*see Fig. 4-33*). Repeat this with the remaining latches.



FIG. 4-33 – FRAME WITH 4 LATCHES INSTALLED

Installation of Prefilter Latches

6. To install the prefilter latches, slide the end of the latch with the 180° turn, over the edge of the header, *as shown in Fig. 4-34*. The latch should be installed at the approximate midpoint of the filter leg.

The prefilter latch should be slid over the header *as shown in Fig. 4-34*.

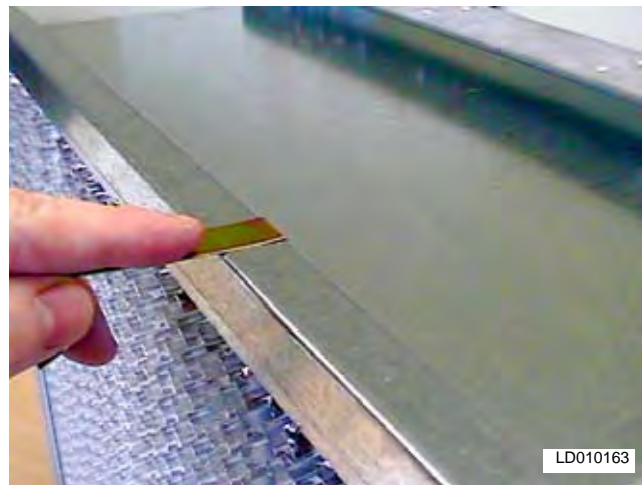


FIG. 4-34 – PREFILTER LATCH AFTER INSTALLATION ONTO FILTER HEADER.

7. Repeat the installation for the remaining prefilter latches.
8. Place the prefilter against the face of the VariCel DH filter. The prefilter latches may have to be re-positioned *as shown in Fig. 4-35*, to allow the proper placement of the prefilter.



**FIG. 4-35 – POSITION PREFILTER IN FRONT OF THE FINAL FILTER.
(2" W/315-003-002 LATCH SHOWN)**

9. Grasp the end of the prefilter latch and “spring” it so that it fits over the edge of the prefilter. Repeat with the remaining latches.

After all remaining prefilter latches have been placed around the prefilter, the finished assembly should look like that in Fig. 4-37.



FIG. 4-36 – SPRING THE END OF THE LATCH SO THAT IT FITS OVER THE EDGE OF THE PREFILTER. (4" W/315-003-004 LATCH SHOWN)

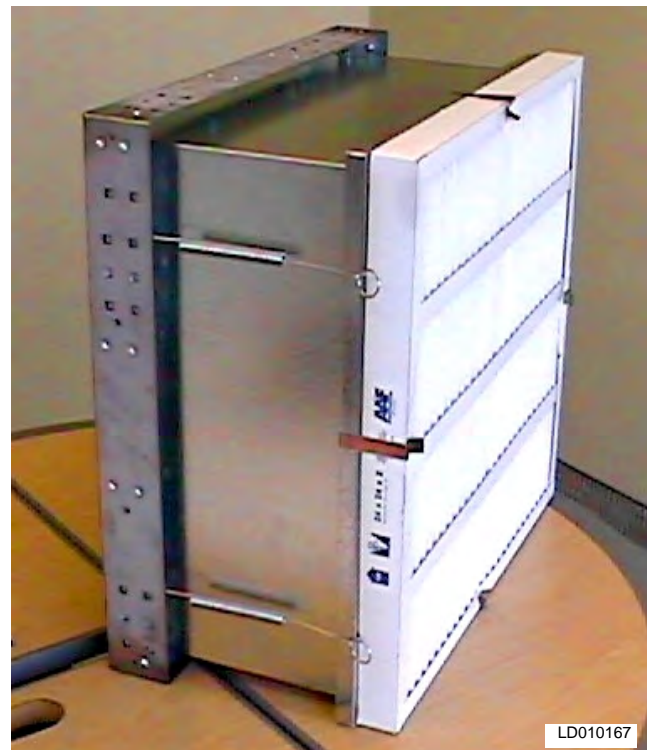


FIG. 4-37 – COMPLETED ASSEMBLY

| VISUAL CONTROL FILTER CLAMPS FOR HEPA FILTERS | | |
|--|--------------------|------------|
| YORK Part Number | Latch Model Number | Length (L) |
| 029-22081-000 | Latch, HEPA Single | 11-1/2" |
| Application: Holds one Astrocel I 11.5" D filter along frame sides. (See Fig. 4-26, 4-27 and 4-28 for application) | | |
| 029-22082 | Latch, HEPA Double | 11-1/2" |
| Application: Holds one Astrocel I 11.5" D filter along frame middle. (See Fig. 4-39, 4-40 and 4-41 for application) | | |

HEPA FILTERS

WELDED BEVEL SEAL FRAME

EXTRUDED ALUMINUM FRAMES FOR GASKETED HEPA FILTER INSTALLATIONS

The Bevel Seal frame is a factory welded, extruded aluminum frame developed specifically for High Efficiency Particulate Air (HEPA) filter installations. Standard Bevel Seal frames accommodate multiple sizes of gasketed HEPA filters 11-1/2" deep. (See Fig. 4-38, 4-40, & 4-41.)

TWO STAGE GASKET COMPRESSION PREVENTS LEAKAGE

The Bevel Seal frame features a two level sealing surface connected by a bevel. This causes the filter gasket to be compressed in two stages as clamping pressure is applied. The outer edge of the gasket is compressed to a greater degree than the inner portion of the gasket. (See Fig. 4-41.)



In the event excessive clamping pressure is applied, the individual cells in the gasket material can be fractured causing the gasket to relax, allowing leakage.

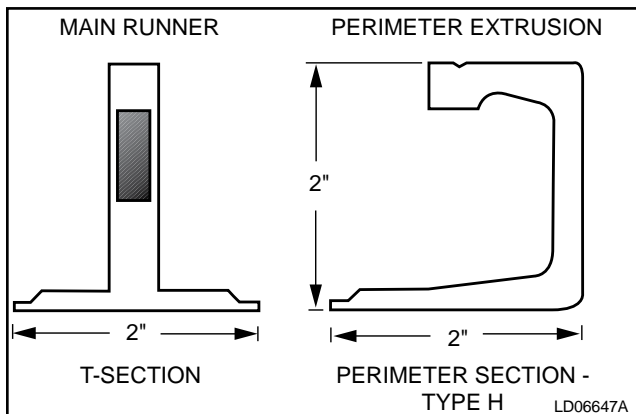


FIG. 4-38 – HEPA FILTER FRAME CROSS SECTION VIEW

VISUAL CONTROL FILTER CLAMPS

(See Fig. 4-39.)

HEPA FILTER APPLICATIONS

Visual Control clamps are designed for use with any conventional gasketed HEPA filter. Located at midpoint of each filter edge, the calibrated spring-loaded clamps maintain up to 100 pounds pressure against the filter at each clamping point. Four clamps are used per filter to assure uniform pressure against the gasket. The clamps have a 1-1/2" wide bearing surface.

EASY CLAMP INSTALLATION

No special tools are required for proper clamp installation. **Just tighten the bolt head until it is flush with the clamp face** to achieve the prescribed compression. Proper clamping pressure is created indefinitely by the calibrated spring.

Single filter clamps are used around the perimeter of the frame bank. Double clamps are used along main runners to secure a filter on either side of the T-section. (See Fig. 4-38, 4-39 & 4-40.)

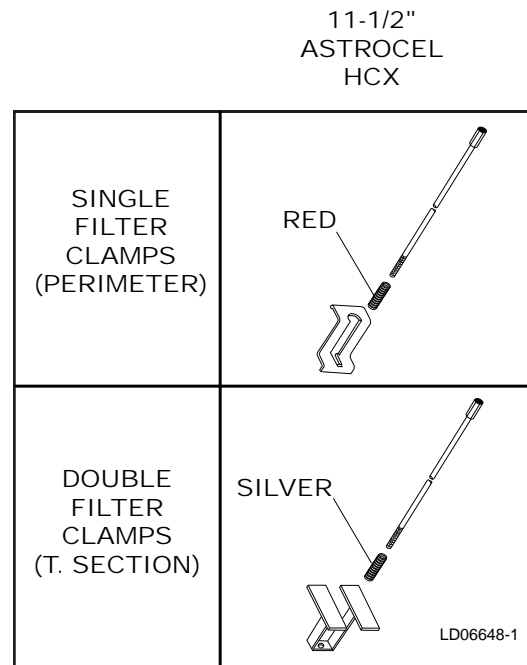


FIG. 4-39 – VISUAL CONTROL FILTER CLAMPS

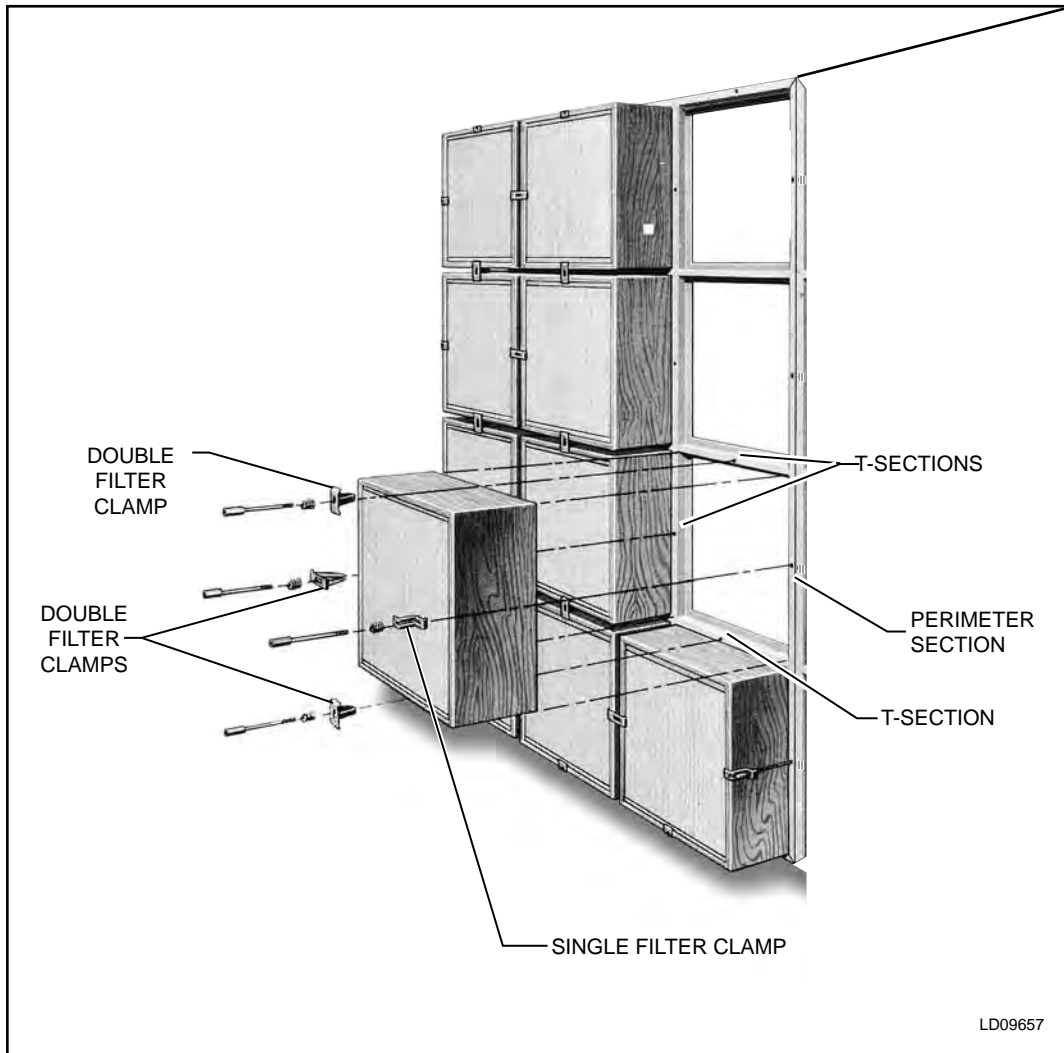


FIG. 4-40 – HEPA FILTER INSTALLATION

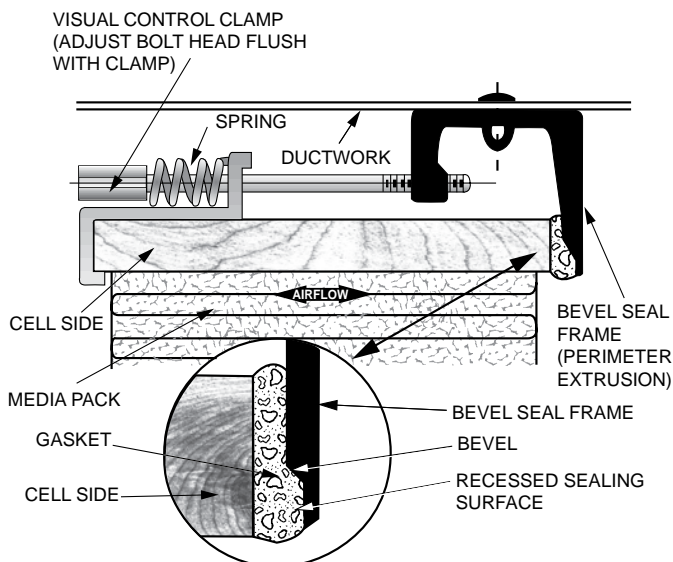


FIG. 4-41 – WELDED BEVEL SEAL FILTER INSTALLATION

ECONOMIZER SEGMENT (DAMPERS)



Prior to occupancy, test ventilation system to ensure that outdoor air dampers operate properly in accordance with the system design.

CLEANING OF DAMPERS

Cleaning of dampers should be performed before operation is hindered in any way. Maintenance personnel must determine when cleaning is necessary based on observation and operation.



Do not use lubricants. YORK suggests cleaning with contact cleaner or 50/50 H²O/alcohol solution. Consult proper building personnel to ensure above solution will not harm personnel or equipment.

HARDWARE CHECK

Make sure all linkage parts, actuators and, mounting brackets are secure.

COIL SEGMENT

COIL CLEANING PROCEDURE

SUGGESTED TOOLS, EQUIPMENT & MATERIALS LIST

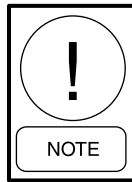
- Pressure washer that does not exceed 2000 PSI.
- Sprayer (utility garden, etc.) applicator.
- Plastic sheeting.
- Duct tape.
- Screening.
- Coil cleaner (safe, commercial grade, disinfecting).
- Garden hose.
- Garden hose spray nozzle.
- Rags.
- Pail.
- Trash bags.
- Power cords.
- Four inch paintbrush.

CLEANING PROCEDURE



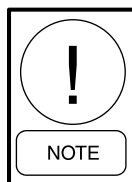
Perform cleaning of dehumidification coils at least once a year or when air pressure drop exceeds 125% of design.

1. Cover electrical components such as fan motors, damper motors, compressors, thermostats, etc. with plastic. Care should be taken on interior coil cleaning. Remove filters; cover fan bearings and any insulation to keep these items free of water damage. Condensate drain piping should be screened to allow coil-cleaning water to flow freely. Screening keeps traps and drain lines from clogging with debris washed from the coils.
2. Prior to any application of wet cleaning materials, use a wide soft bristle paint brush to dust off any heavy dust, leaves, bugs or other foreign matter that may be on the coil fin surface.



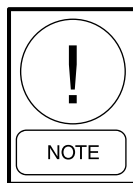
Safety glasses should be worn when cleaning coils.

3. When possible, remove dirt lodged in the depth of the coil by using clean oil-free air under pressure. Caution should be taken not to use extreme high-pressure air as this may cause fin surface damage. Direct the air straight at the openings between the fins and never at an angle, which may bend the fins against one another. Always apply the air from the air leaving side of the coil.
4. On heavily soiled coils, use a safe commercial grade coil cleaner.



Follow the safety and mixing instructions as noted on or with the cleaning agent.

5. Spray the cleaning agent on both sides of the coil to be cleaned. Allow the cleaning agent to remain in contact with the dirty surface for about 5 minutes or as recommended by the agent instructions. Then flush the coil with clean water from a hose (with spray nozzle or from pressure washer). Flush from the air leaving side of the coil. Caution should be taken, as extreme water pressure may result in fin surface damage. Direct the water straight at the openings between the fins and never at an angle, which may bend the fins against one another. This process will wash away surface dirt on the air entering side of the coil, and prevent it from loading within the depth of the coil.
6. Most cleaners are concentrated detergents and can be diluted with up to 10 parts of water. Dilute as per cleaning agent instructions and coil condition. Re-spray both sides of the coil with cleaner. Allow to stand 5 minutes and flush as described previously. Finish flushing from both sides of the coil.



Follow cleaning agent instructions. Agent should meet environmental and OSHA standards.

- 7 Some extreme oil and dirt conditions may require steam cleaning. Most steam equipment can be adjusted to provide a mixture of water and steam at a moderate pressure. Steam alone without the presence of water does not work well with most cleaning agents. Cleaning the coils with steam should be done as described previously.
8. Comb out any bent or flattened areas of fin surface.
9. Restore equipment to operational state.

CONDENSATE DRAIN PAN, TRAP AND DRAIN LINE CLEANING PROCEDURE



Clean condensate drain pan, trap, drain line and adjacent wetted surfaces at least once per year or as often as required to retard growth of microbial substances.



Testing of Drain Pans - To minimize conditions of water stagnation that may result in microbial growth, drain pans shall be field-tested under normal operating conditions to ensure proper drainage.

Exception: Field testing of drain pans is not required if units with factory-installed drain pans have been certified (attested in writing) by the manufacturer for proper drainage when installed as recommended.

TOOLS AND MATERIALS

- Toilet bowl brush or similar utility cleaning brush.
- Cleaning agent (safe, commercial grade, disinfecting).
- Rags.
- Trash bags.
- Garden hose with spray nozzle or power washer.
- Scraper.
- Screening.
- Wet vacuum.

CLEANING PROCEDURE

1. Cover any nearby components such as motors, control devices or wiring.
2. Sweep, gather and remove debris from drain pan, auxiliary pans and splash guards.
3. Scrape loose and remove any clinging substances.
4. Cover drain pan outlet with screening to prevent drain clogging.
5. Prepare cleaning agent per manufacturer's instructions.
6. Apply cleaning agent with spray applicator or brush.
7. Apply cleaner to **ALL** surfaces including: underside of coil, header and return bends if in air stream, coil supports, coil wall or bulkhead, auxiliary drain pans, splash guards, any other surfaces subject to wetting by condensation dripping or carried by normal airflow, drain pan and outlet.
8. Add ample amount of cleaning agent to drain line and trap.
9. Allow cleaner to stand for time required by manufacturer's instructions.
10. Flush with clean water from pressure washer or garden hose with spray nozzle.
11. Apply as much water under pressure as possible to drain outlet to clean trap and drain line.
12. Remove water from any puddle areas with wet vacuum.
13. Wipe down if necessary to remove any stubborn material.
14. Restore equipment to operational state.

FREEZE PROTECTION

All chilled water, hot water and steam coils can be damaged during freezing weather. Pre-cautionary measures must be taken to prevent freezing such as:

- For all year operation, glycol and other antifreeze solution must be circulated.
- During winter operation and shutdowns such as power failure, night shutdown and weekend shutdown, the controls must be installed so the valves will go to the full heat position, and all fresh air dampers go to the full closed position. The water circulation pumps must keep circulating water through the coils and/or auxiliary heat must be maintained inside the YORK Solution unit cabinet.
- Draining each coil and related piping such as traps and making sure that all low areas also drain.
- After draining, flush coils with an antifreeze solution such as propylene glycol. A solution of 50% glycol and 50% water will protect from freezing to approximately 35°F below zero at sea level. Use adequate mixture for the geographic area of the installation.

WINTERIZING DRAIN TRAPS

During the winter months when the cooling system is turned off and the unit is exposed to freezing conditions, an antifreeze solution, which is environmentally friendly and safe for the roof can be poured in the condensate drain trap to prevent freezing and possible damage. The condensate drain trap may also be removed as well as heat traced and insulated.

ENERGY RECOVERY WHEEL

TOOLS

- Brushes.
- Loctite.
- Screwdrivers.

MATERIALS

- Acti-Klean, Granger stock # 5W402. or alkaline detergent.

CLEANING



The need for periodic cleaning of the Energy Recovery Wheel will be a function of operating schedule, climate and contaminates in the indoor air being exhausted and outdoor air being supplied to the building.

WHEEL

- To clean, gain access to the Energy Recovery Wheel and remove the segments (see Section 5 “Replacing Wheel Segments”). ►
- Brush or vacuum foreign material from the face off the wheel.
- Wash the segments in a 5% solution of non-acid based coil cleaner (see material list above) or alkaline detergent and warm water.
- Allow segments to soak in solution until grease and tar deposits are loosened. An overnight soak may be required to adequately loosen heavy deposits of tar and oil based contaminants. Before removing from solution, rapidly run finger across surface of segment to separate polymer strips for better cleaning action. Rinse dirty solution from segment with clean water (see Fig. 4-42) and allow excess water to drain prior to remounting segments in the wheel (see Section 5, “Replacing Wheel Segments”). ► A small amount of water remaining in the wheel will be dried out by the airflow.

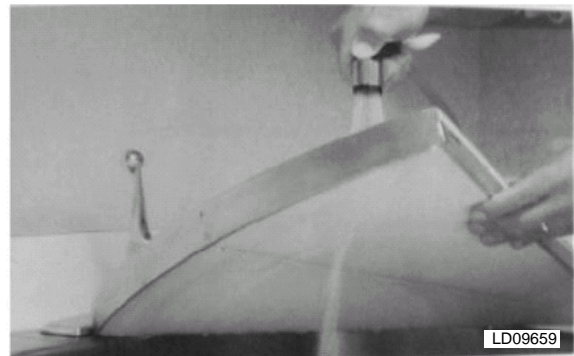
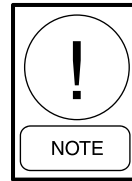


FIG. 4-42 – RINSE SEGMENTS WITH CLEAN WATER



Some staining of the desiccant may remain and is not harmful to performance.



Do not use acid based cleaners, aromatic solvents, steam or temperatures in excess of 170°F: damage to wheel may occur!

ADJUSTMENT OF AIR SEALS

Four adjustable diameter seals are provided on each cassette to minimize transfer of air between the counter flowing airstreams (see Fig. 4-43).

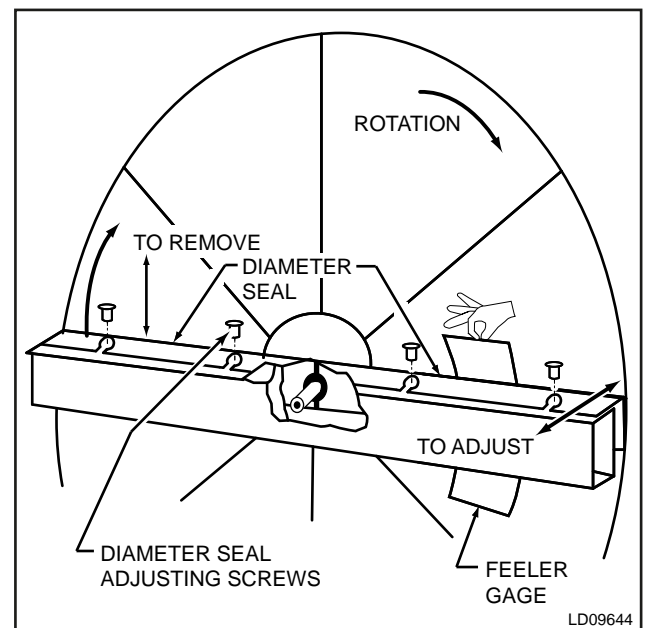


FIG. 4-43 – DIAMETER SEAL ADJUSTMENT

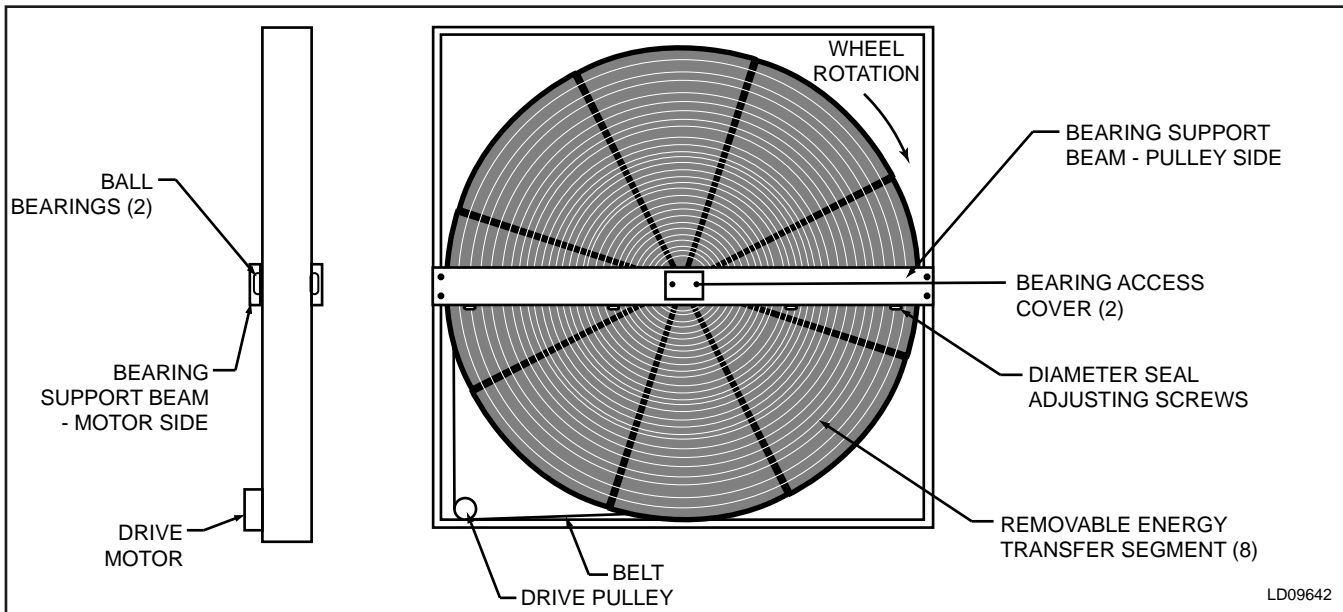


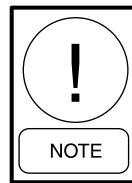
FIG. 4-44 – ENERGY RECOVERY WHEEL, BEARING SUPPORT BEAM SIDE

- To adjust diameter seals, loosen diameter seal adjusting screws and move diameter seal away from wheel surface.
- Rotate wheel clockwise until two opposing spokes are hidden behind the bearing support beam (see Fig. 4-44).
- Using a folded piece of paper as a feeler gage, position paper between the wheel surface and diameter seals. Adjust seals towards wheel surface until a slight friction on the feeler gage (paper) is detected when gauge is moved along the length of the spoke.
- Retighten adjusting screws and recheck clearance with “feeler” gage.

- The wheel drive pulley is secured to the drive motor shaft by a combination of either a key or D slot and setscrew. The setscrew is secured with removable locktite to prevent loosening. Annually confirm setscrew is secure.
- The wheel drive belt is a urethane stretch belt designed to provide constant tension through the life of the belt. No adjustment is required. Inspect the drive belt annually for proper tracking and tension. A properly tensioned belt will turn the wheel immediately after power is applied with no visible slippage during start-up.

WHEEL DRIVE COMPONENTS

- The wheel drive motor bearings are pre-lubricated and no further lubrication is necessary.



If slippage is detected, replace wheel drive belt as soon as possible. A non-rotating wheel in the active air stream is likely to become clogged. Contact local Johnson Controls Service to order replacement belt. See Section 5 “Belt Replacement” for Energy Recovery Wheel drive belt replacement procedure. ►


|  MAINTENANCE RECOMMENDATIONS FOR SOLUTION AIR HANDLER (Includes suggested IAQ minimums for ASHRAE Std. 62-2001 Compliance) | | | | |
|---|---------|-----------|--------|----------------|
| PROCEDURE | MONTHLY | QUARTERLY | YEARLY | OTHER |
| Clean exterior of air handler cabinet. | | | | As Needed |
| Inspect doors, handles, latches and hinges for proper operation. | | | X | |
| Inspect door gaskets for damage and proper seal. | | | X | |
| Inspect panels for damage. | | | X | |
| Inspect air hoods and air louvers for damage and debris. | | | | 6 months |
| Inspect bird screens for damage and debris. | | | | 6 months |
| Inspect bird screens for damage, dirt and debris. | | | | 6 months |
| Clean fan segment and fan assembly (supply, return, exhaust). | | | X | |
| Check fan housing, wheel, shaft, frame, inlet vanes and bearings for damage, wear, loose parts, dirt and debris. | | | X | |
| Check fan base, vibration isolators and thrust restraints for damage, wear, loose parts, dirt and debris. | | | X | |
| Check flex connector for damage and wear. | | | X | |
| Check the cleanliness of the filters and replace or clean as required. | X | | | See IOM Tables |
| Check filter frames (filter tracks) for residual contaminants and clean as necessary. | | X | | |
| Verify filter gauge and/or switch function properly. | X | | | |
| Check drive kit for damage, loose parts, wear, dirt, alignment and belt tension. | | X | | |
| Check belt tension. | | X | | |
| Lubricate fan bearings. (Ball Bearing-Table 4-2, Roller Bearing-Table 4-3, Split Pillow Block-Table 4-4) | | | | See IOM Tables |
| Check condition of extended lubrication lines when present. | | X | | |
| Clean variable inlet vanes. | | | X | |
| Check adjustable fan motor base and mounting hardware for loose parts. | | | X | |
| Check adjustable fan motor base for damage. | | | X | |
| Check fan motor for leaky bearing seals. | | | X | |
| Check fan for motor damage. | | | X | |
| Clean dampers. | | X | | |
| Check for dirt, dust & debris in air vents on fan motor housing. | | | X | |
| Clean dehumidification coils. | | | X | |
| Clean condensate drain pan, trap, drain line and adjacent wetted surfaces. | | | X | |
| Check, clean and calibrate controls. | | | | 6 months |
| Check Energy Recovery Wheel, clean media, adjust seals, replace belt | | | | As Needed |

FIG. 4-45 – MAINTENANCE REQUIREMENTS FOR YORK SOLUTION HANDLER

¹ For operating and maintenance requirements listed above, refer to appropriate service literature, or contact your local YORK Service Office.
² This procedure must be performed at the specified time interval by a Qualified Technician. A record must be maintained should proof of adequate maintenance be required for warranty validation.
³ More frequent maintenance may be required depending on actual operating conditions.

THIS PAGE INTENTIONALLY LEFT BLANK

5.0 SERVICE AND REPAIR



Rotating parts and electrical shock hazards exist. Lock out and tag out the fan motor(s) and heat power disconnects before servicing. FOLLOW THE LATEST "LOCKOUT TAGOUT" PROCEDURE. Failure to follow proper safety precautions may result in serious injury or death. Refer to general safety guidelines and safety symbols located at the front of this Manual. ►



Always replace RED metal tab on access doors that provide access to moving parts. This mechanical protection from moving parts is required by UL-1995.

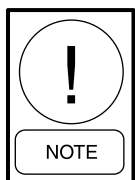
Always replace RED metal tab on access doors that provide access to pressurized areas. This mechanical protection is to prevent accidental release of access doors under positive pressure.



Do not weld or use torches on the exterior or interior of the unit housing. The housing contains polyurethane insulation, which when under combustion will produce harmful, toxic gases resulting in personal injury or death.



***DO NOT PENETRATE WIREWAYS** in any manner. These sheet metal channels, which run along the top panel, contain electrical wires and connections. Electrical shock and/or damage to the unit may result.*



Never use silicone caulk/sealant or caulk/sealant containing silicone in or on any air handling equipment. [Only exception is when provided (high temperature) with gas heat venting].

SERVICE TOOLS AND EQUIPMENT

- Complete set of mechanics hand tools.
- Observation mirror.
- Fin comb (straightener).
- Heat gun.
- Straightedge.
- Tachometer.
- Manometers capable of .01" To 36" combined.
- **Digital Manometer (replaces Magnehelic Gauge).**
 - Digital Manometer
 - Cat. #475-1 FM-AV
 - Series: 475-1 Mark III
 - Range: 0 to 19.99 In. W.C.
 - Dwyer Instruments, Inc.
- Pitot Tube.
- Duct hood.
- Velometer.
- Psychrometer.
- Combustion Efficiency Analyzer.
- Standard refrigeration gauges/manifold.
- Refrigerant re-claimer.
- Refrigerant leak detector.
- Vacuum pump.
- Gas torches (soldering and/or brazing).
- Fire extinguisher.
- Electronic Temperature Meter with a minimum of 3 Leads.
- Meg-ohm Meter.
- Phase Meter.
- Capacitor Analyzer.
- Clamp on ammeter.
- Multi-meter or meters capable of reading the following:
 - One thousand volts AC/DC.
 - Amperes.
 - Ohms.
 - Millivolts.
 - Milliamps.
 - Microfarad.

SERVICE INFORMATION

All necessary tags and decals to aid in service or to indicate caution areas are provided. Electrical wiring diagrams are attached to the control panel access door. Installation, operation and maintenance manuals are supplied with each unit.

The YORK Solution offers unlimited unit access with completely removable panels. All of the unit panels, including the top panels can be completely removed.

The removal of top panels allows the use of overhead cranes and gantries in removing and servicing of components. Fan and filter segments come equipped with doors as a standard feature.

TROUBLESHOOTING

An HVAC air system includes the air handling unit and the entire air circuitry through which airflows. Included in the system are such components as ductwork, fittings, branch ducts, dampers, heat exchangers, filters, sound traps, coils, elbows, diffusers, grilles, VAV's, MIT's and other items through which airflows or which offer obstruction to airflow.

While differences in temperature and humidity may cause air movement, it may be considered very slight in comparison to the positive circulation required in an air conditioning system. To accomplish this air movement, a fan has two functions to perform:

- Produce sufficient pressure or head to accelerate the mass of air from a state of rest to the required velocity.
- Produce sufficient pressure to overcome any resistances to the flow of air.

The determination of these pressures is a very important part of troubleshooting an air conditioning system. The generally accepted standard instrument for measuring these unit pressures is the Pitot Tube (see Fig's 5-1 & 5-2). The Pitot Tube is used in conjunction with an Inclined Manometer, Magnehelic Gauge, or a Tube Manometer.

When the Pitot Tube is used in conjunction with these instruments, one is able to read velocity pressure (Vp), static pressure (SP), and total pressure (Tp) within the system.

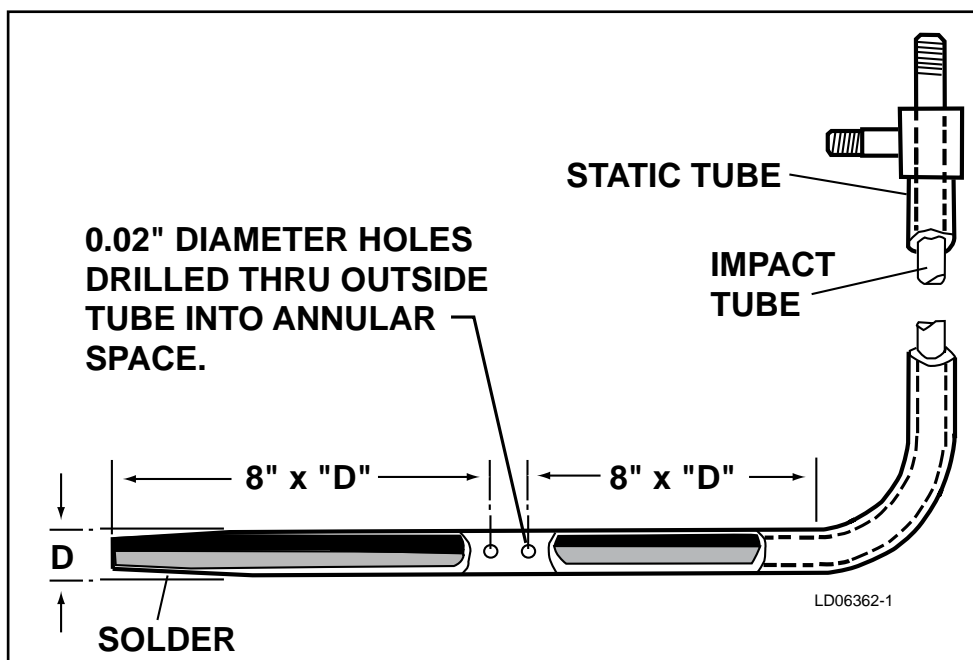


FIG. 5-1 – CONSTRUCTION OF PITOT TUBE

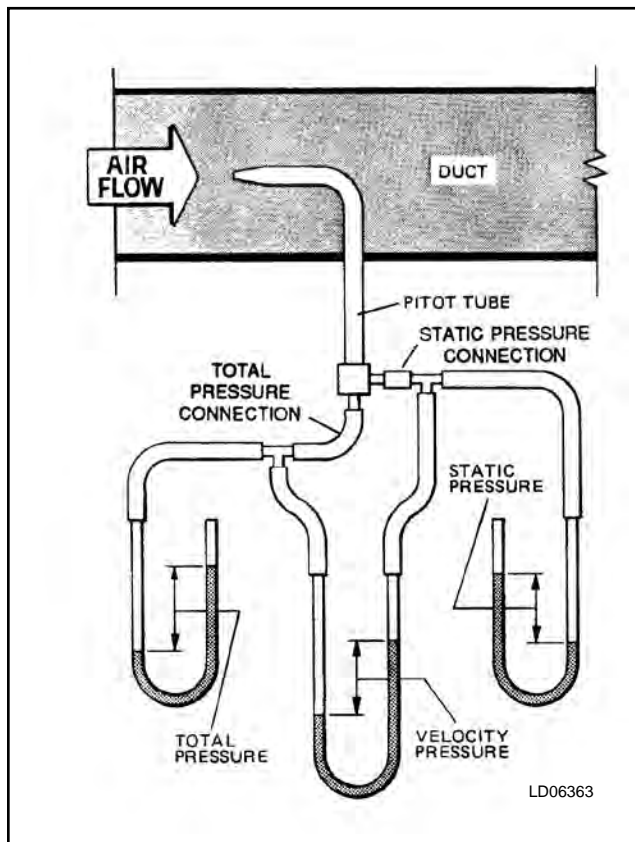


FIG. 5-2 – PITOT TUBE

PITOT TUBE

The Pitot consists of an impact tube within a larger static tube. When the impact tube is pointed directly into the air stream, the small static pressure holes are perpendicular to the air stream and are not affected by air velocity (see Fig. 5-2).

To read velocity pressure, the total pressure tap at the end of the Pitot Tube is connected to one leg of a manometer and the static pressure tap at the other leg of the manometer (see Fig. 5-3).

INCLINED MANOMETER

This instrument, is a simple, foolproof device, which responds directly to the air pressure exerted against it (transmitted from the Pitot Tube), and reads directly in inches of water. Ranges for these instruments vary, and the technician should have one or more instruments to cover the range of 0 to 8 inches of water (see Fig. 5-3).

Before using the Inclined Manometer, ensure the instrument is level and then adjust the meniscus to the zero mark. The adjustment knob is located at the base of the fluid reservoir.



FIG. 5-3 – INCLINED MANOMETER

MINIHELIC FILTER GAUGE

The Minihelic Filter Gauge is a diaphragm-operated gage that has several advantages over a liquid manometer.

Unless extreme accuracy is required, this instrument may replace the manometer for average air conditioning work, and like the manometer, is available in a variety of ranges. The dial is only 2 inches in diameter and therefore has a limited scale; several instruments are required to cover the normal ranges encountered in average air conditioning jobs (see Fig. 5-4).

The Minihelic Filter Gauge should be factory-installed level. Adjust indicator to zero with no airflow or press. diff. across the sensors. Adjustment screw is located at the bottom behind of the plastic cover. When airflow is initiated, the indicator should move to the right. If it moves in the opposite direction, reverse the tubes.



FIG. 5-4 – MINIHELIC FILTER GAUGE

“U” TUBE MANOMETER

Pressure is defined as force per unit area - and the best way to measure air pressure is to balance a column of liquid of known weight against the air pressure and measure the height of liquid columns so balanced. The units of measure commonly used are: inches of mercury (in. Hg.), using mercury as the fluid; and inches of water (in. WG), using water or oil as the fluid.

Instruments employing this principle are called manometers. The simplest form is the basic and well-known U-tube Manometers (*see Fig. 5-5*). This device indicates the difference between two pressures or between a single pressure and atmosphere, when one side is open to atmosphere.

If a U-tube is filled to the halfway point with water and air pressure is exerted on one of the columns, the fluid will be displaced. Thus, one leg of water column will rise and the other falls. The difference in height “h” which is the sum of the readings above and below the halfway point indicated the pressure in inches of water column.

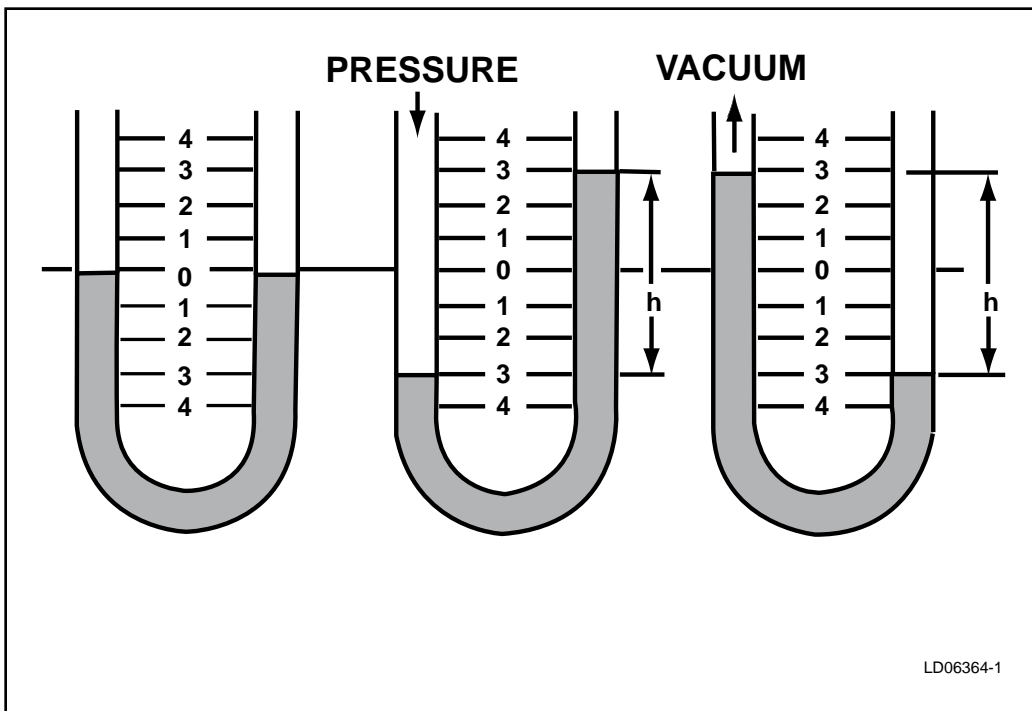
The U-tube Manometer is a primary standard because the difference in height between the two columns is always a true indication of the pressure regardless of variations in the internal diameter of the tubing.

For use on all YORK air units, the manometers should cover at least a 26 inch range (*see Fig. 5-6*).



27928B

FIG. 5-6 – SLACK-TUBE MANOMETER



LD06364-1

FIG. 5-5 – “U” TUBE MANOMETERS

DUCT PRESSURES AND HOW THEY WORK

VELOCITY

When air moves at a given velocity in a duct it creates a pressure corresponding to the velocity; this is a measure of the kinetic energy in the fluid and it is known as the velocity pressure (V_p). Velocity pressure is always exerted in the direction of air- flow. The relationship between the velocity and the velocity pressure may be expressed by the following formulas:

$$V_p = \left(\frac{V}{4005} \right)^2$$

$$V = 4005 \sqrt{V_p}$$

It is therefore a simple matter to determine the velocity (FPM) of an air stream so the V_p can be measured. For example, if a Pitot Tube Manometer hook-up reads 0.250 inches water, we substitute for the previous equation:

$$4005 \sqrt{0.250} = 2002 \text{ FPM}$$

STATIC PRESSURE

Independent of its velocity, air, when confined within an enclosure such as a duct or tank, will exert itself perpendicularly to the walls of the enclosure. This is the compressive pressure existing in a fluid, and it is known as the static pressure (SP). Unlike velocity pressure, which is always positive, static pressure when it is above atmospheric pressure will be positive but when below atmospheric pressure it will be negative. The discharge side of a fan in an air system will read a positive pressure, the inlet side will read a negative or minus pressure.

TOTAL PRESSURE

Static pressure is exerted whether air is at rest or in motion. The algebraic sum of static pressure and velocity pressure gives the total pressure (T_p). Therefore:

$$V_p = TP - SP$$

The manometer does not sense the actual velocity pressure directly but by using the Pitot Tube hook-up with the static opening connected to the low pressure side of the gauge, and the total pressure opening connected to the high pressure side of the gauge, the manometer will read the difference between the two, or the velocity pressure.

Velocity pressure and static pressure change in the ductwork with every change in the duct configuration, but the total pressure, on the other hand, remains constant. Hence, as the velocity pressure decreases, the static pressure increases and vice versa, because the static pressure is always the difference between total pressure and the velocity pressure. It should be remembered, however, that in an actual duct system, the internal friction would cause a loss of total pressure.

The static pressure in an exhaust system is always below atmospheric pressure, and it is customary among ventilation engineers to omit the minus sign affecting the static (gauge pressure). These men know, of course, that the total pressure is higher than the static pressure by the amount of the velocity pressure.

When the unit is designed for connection to a duct system and the installing contractor assembles ducts, elbows, registers, grilles, etc. to the outlet and/or inlet of the unit, the static pressure drop through this external ductwork is called external static pressure (*see Fig. 5-7*).

Fans selected must be capable of moving the desired airflow through the entire air moving system including the unit (internal SP) and the duct system (external SP).

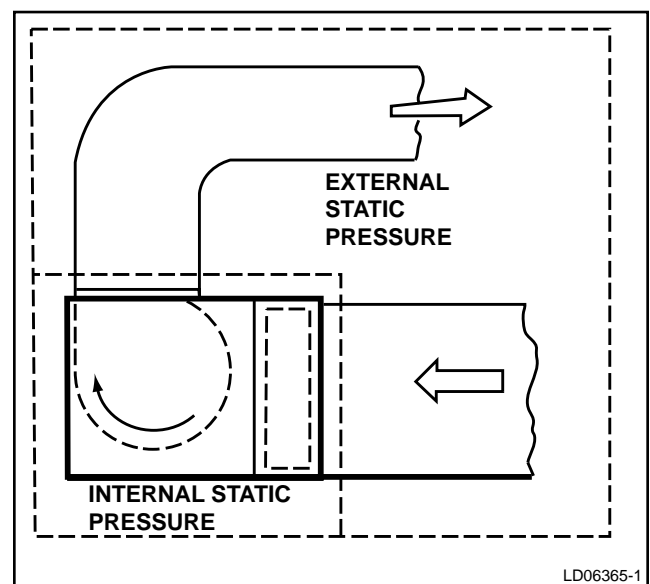


FIG. 5-7 – STATIC PRESSURE - AIR SYSTEM

At a given flow rate the internal pressure losses plus the external static pressure losses equal the system static pressure or the summation static pressure.

These pressures are of great importance when troubleshooting for causes of reduced capacity, vibration and noise. Changes in the cross sectional area of a duct (contractions or enlargements) cause changes in the velocity of the air flowing through the duct.

When the velocity decreases, the velocity pressure also decreases. Some of the velocity energy is lost because of the design of the duct where the area changes. Some of the velocity energy is converted into static pressure energy in the continuing ductwork. This conversion of velocity energy to static pressure is called static regain.

TROUBLE SHOOTING TIPS

For further assistance in troubleshooting the YORK Solution unit, refer to “Troubleshooting Tips” Table 5-8. ►

REQUESTING ASSISTANCE

When contacting Johnson Controls for assistance the following information will be required:

- YORK Order No.
- Job name (not contractor).
- Unit Model No.
- Customer’s Unit Identification.
- Design data and actual data.
 - Fan RPM.
 - Unit SP (across fan).– Unit CFM.
 - Pressure drop of water across cooling coil (PSIG).
 - Air pressure drop across cooling coil (inches of water).
 - Temperature differential across cooling coil.
 - Motor voltage.
 - Motor amperes.
- For fan or motor RPM, use a tachometer, stroboscope or revolution counter.
- The voltage and amperes can be obtained by using the appropriate multimeter test device.
- A sketch of the duct configuration would assist us in trying to resolve the problem.

- The most important item is to provide a detailed explanation of the problem.
- An orifice is the best method of measuring flow in piping. This is also true in an air system.

COMPONENT REPLACEMENT, ADJUSTMENT & REPAIR



Disconnect or disable electric motor and lock out.

FAN REPLACEMENT & ADJUSTMENT

TOOLS REQUIRED

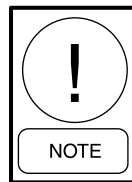
- Standard mechanic’s and electricians hand tools.
- Cordless screwdriver.
- Hex head socket set.
- Socket extension.

MATERIALS REQUIRED

Correct parts for the application (see Form 102.20-RP1). ►

PROCEDURE

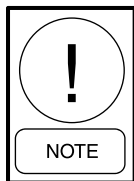
1. Remove unit side panel.



If unit is not high enough to work from side, remove top panel (see IOM Section 5, “Panel Replacement”). ►

2. Remove flex connector parts.
3. Remove belts.
4. Remove sheave.
5. Remove fan hold down bolts.
6. Remove fan from fan base.
7. Remove skid, crates and packaging material carefully from new fan.

8. Move the new fan to the final mounting position.
9. Place the new fan on mounting structure. Carefully level fan using shims as required at all mounting hole locations. Bolt down the fan.
10. Reinstall flex connector parts.
11. Reinstall sheave and belts.
12. Perform sheave alignment (*see Section 4 of this IOM*). ►
13. Check and adjust belt tension (*see Section 4 “Belts” of this IOM for checking belt tension ► and Section 4 “Adjustable Motor Base Operation” ► and “Sheave Alignment” for belt tension adjustment*). ►
14. Start up fan (*see Section 3 “Start-Up” of this IOM*). ►
15. Perform dynamic balance (*see Section 4 of this IOM*). ►



Fan variations are shown in Fig. 5-8.

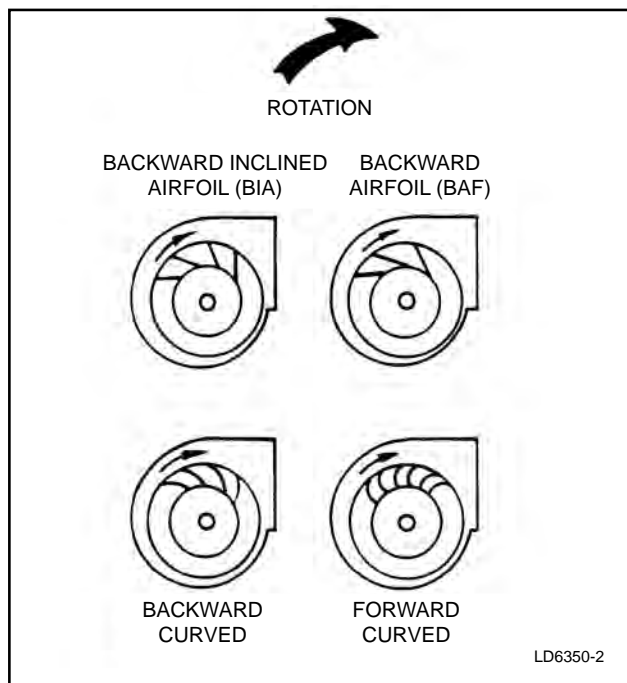


FIG. 5-8 – TYPES OF CENTRIFUGAL FAN IMPELLERS

FAN REPAIR

TOOLS REQUIRED

- Standard mechanic’s and electricians hand tools.
- Allen torque wrenches.
- Cordless screwdriver.
- Emery cloth.
- Rubber mallet or brass bar.
- Flat file.
- Nail set.

MATERIALS REQUIRED

Correct parts for the application (*see Form 102.20-RP1*). ►

FORWARD CURVED FAN WHEEL REPLACEMENT

The forward curved fan wheel must be removed through the fan discharge opening. The location of hubs, fan wheel, and shaft must be marked so each of these components can be reassembled in the same location (*see Fig. 5-9*). This will preserve the balance of the rotating assembly. Proceed with the following steps:

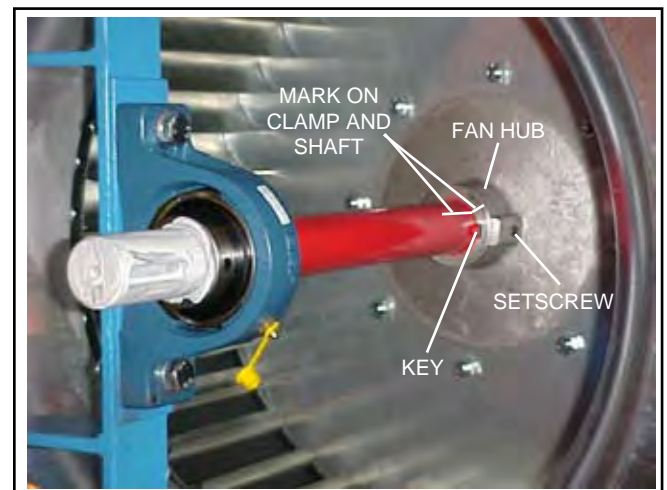
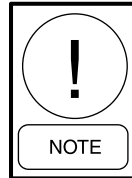


FIG. 5-9 – FC FAN SHAFT AND WHEEL MARKING

1. Disconnect all ductwork or guards attached to the blower housing to permit unobstructed access.
2. Remove the cut off plate attached at the discharge or blast area of the blower housing.

3. Thoroughly clean the shaft of all grease and rust inhibitor. Be careful not to contaminate the bearing grease. Use emery cloth to remove all rust or the wheel may become “locked” to the shaft.
4. Loosen and remove setscrews on both bearing locking collars. Inspect and, if necessary, replace.
5. Loosen and remove setscrews from both sides of the wheel hub. Inspect and, if necessary, replace.
6. Using a rubber mallet or brass bar, slowly drive the shaft in one direction until the setscrew marks on the shaft are fully exposed. File the marks completely smooth. Drive the shaft in the opposite direction and file smooth the setscrew marks. Continue to clean the shaft of all dirt and residuals.
7. To remove the key, use a rubber mallet or brass bar to drive the shaft and wheel in one direction. Drive the key in the opposite direction using a nail set or smaller size key stock until the key is completely free of the wheel. Be sure that key does not get bent by allowing it to ride up the key way edge. The slightest bend will prevent quick assembly. Should this occur, replace the key stock with a key of the same size and length.
8. Remove the shaft, supporting the weight of the wheel, particularly for larger diameter wheels. Do not allow the weight of the shaft to be supported by one bearing as you disassemble.
 - a) Remove the wheel through the discharge or outlet area of the blower housing.
 - b) File the setscrew marks on the key until smooth.

- c) Reassemble in reverse order, center the wheel between the edges of the inlet cones. If bearings were removed or replaced, be sure to reuse any shim stock found between the mounting support/plate and bearing housings.
 - d) Torque all hardware (*see table 5-1*).
9. Dynamic rebalancing the fan assembly is recommended.



Refer to AMCA Publication 410-90 “Recommended Safety Practices” for users and installers of industrial and commercial fans.

These procedures must be followed to protect personnel and include isolating the fan from any electrical supply.

Service should only be performed by experienced and trained personnel.

AIRFOIL FAN WHEEL REPLACEMENT

The airfoil wheels can be removed from the side of the fan housing by removing one or both unit side panels. It is possible to remove the fan wheel through the fan discharge opening.

TABLE 5-1 – TORQUE FOR TIGHTENING SET SCREWS

| SETSCREW DIA. | HEX WRENCH SIZE ACROSS FLATS | MIN. RECOMMENDED TORQUE | |
|---------------|------------------------------|-------------------------|--------------|
| | | INCH LBS. | FOOT LBS. |
| 1/4 | 1/8 | 66 - 85 | 5.5 - 7.08 |
| 5/16 | 5/32 | 126 - 164 | 10.5 - 13.7 |
| 3/8 | 3/16 | 228 - 296 | 19.0 - 24.7 |
| 7/16 | 7/32 | 348 - 452 | 29.0 - 35.7 |
| 1/2 | 1/4 | 504 - 655 | 42.0 - 54.6 |
| 5/8 | 5/16 | 1104 - 1435 | 92.0 - 119.6 |

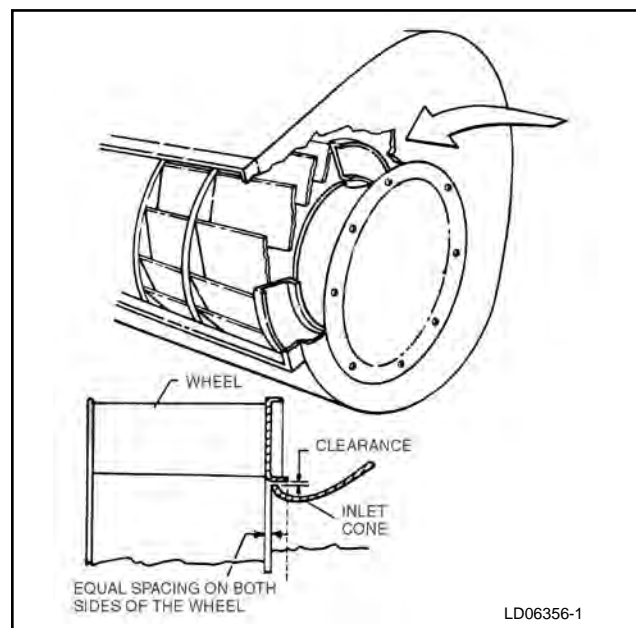


FIG. 5-10 – AIRFOIL WITH CONE ASSEMBLY

The first step in the removal of the fan wheel is to remove the inlet cone from the side of the fan from which the wheel is to be removed from the unit. If the wheel is to be removed from the fan discharge, one of the inlet cones must be removed from the side of the housing since the cones nest inside the blower wheel (see Fig. 5-10). The remaining steps for removing the assembly are the same as those provided in the instructions for removing the forward curved fans.

Dynamic rebalancing the fan assembly is recommended.

FAN BEARING REPLACEMENT

SEALED BEARINGS

TOOLS REQUIRED

- Standard mechanic's hand tools.
- Medium flat file.
- Torque wrench, 0 to 250 in.-lb. range.
- Hex (Allen) socket set for torque wrench.
- Plastic or brass hammer.
- Brass bar or pipe of proper size.
- Slings or jack to support larger wheels/shafts.

MATERIAL REQUIRED

- Exact replacement bearings (always in pairs).
- Steel wool, fine sanding cloth or fine emery cloth.
- Blocking or temporary support for fan wheel/shaft.
- Red "Locktite" or equivalent.

PROCEDURE

See Fig. 5-11

1. Remove belts (see Section 4, "Adjustable Motor Base Operation"). ►
2. Remove sheave and key (see Section 5, "Sheave Replacement and Adjustment"). ►
3. Support fan wheel/shaft with cribbing, slings or jacks.

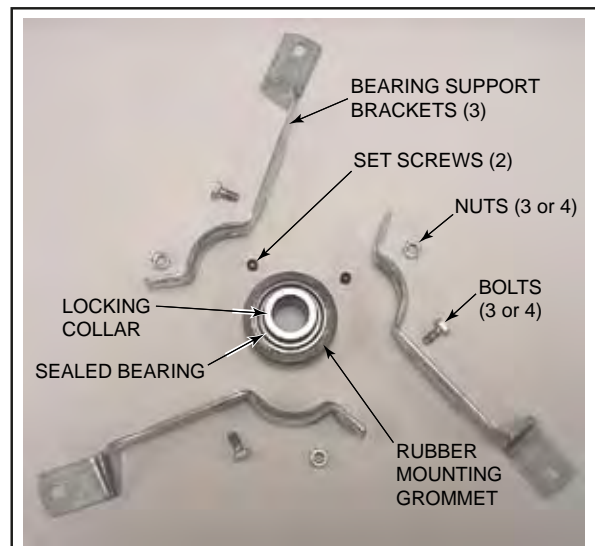


FIG. 5-11 – SEALED BEARING

LD09662

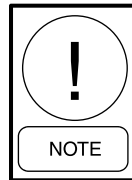
4. Clean shaft until it is shiny from bearings to ends of shaft.
5. File any burrs or set screw impressions from shaft.
6. Partially disassemble the bearing support brackets by removing the bolts closest to the bearings on the bearing support brackets. Depending on fan size, there are either 3 or 4 bolts with nuts and "Locktite".
7. Remove the setscrews from the bearing locking collars (two on one side of each bearing, 90 degrees apart). Inspect and, if necessary, replace.
8. Pull each bearing with its rubber mounting grommet, out of the bearing support brackets as much as possible.
9. Remove bearings. If a bearing will not move, shine the shaft behind the bearing and bump the bearing toward the fan wheel. Use plastic hammer, brass bar or brass pipe. Then de-burr and shine the shaft where the bearing was previously located. Finally, pull the bearing off.
10. If the bearing sticks while pulling it off, don't force it. Clean, shine and de-burr the shaft where ever necessary.
11. Make sure the shaft is straight and not worn at the bearing location.
12. With the shaft and bearings clean, slide the new bearings onto the shaft with the setscrews facing away from the fan wheel.

13. Reassemble the new bearings with rubber mounting grommets gently into the support brackets.
14. Remove any temporary supports or blocking of fan wheel/shaft.
15. Apply red “Locktite” or similar product to bolts and re-install them with nuts in the bearing support brackets. Be sure the bearings are seated in the brackets and not twisted. Tighten to appropriate torque rating.
16. Slide the shaft in or out of the new bearings to center the wheel between the inlet cones on both sides of the fan. This is not critical, however should be adjusted as close as possible by feeling the gaps with the fingertips.
17. Install the setscrews in the drive side bearing but only tighten lightly.
18. Spin the fan wheel by hand to insure no rubbing will occur. Readjust if necessary.
19. Install setscrews in opposite side bearing and tighten all setscrews to correct torque rating (see Table 5-1). ▶

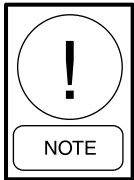
- Slings or jack to support larger wheels/shafts.
- Quarter inch drill bit.

MATERIAL REQUIRED

- Exact replacement bearings (always in pairs).
- Steel wool, fine sanding cloth or fine emery cloth.
- Blocking or temporary support for fan wheel/shaft.
- Grease (see Section 4 or paperwork supplied with new bearings). ▶
- Quarter inch roll pins (1 on each small bearing, 2 on each large bearing).



Our standard is to use standard pillow block bearings with setscrew type locking collars. If the fan bearings have separate eccentric type locking collars (see Fig. 5-13), refer to special instruction “FAN BEARING REPLACEMENT-ECCENTRIC LOCKING COLLAR” elsewhere in this section. ▶



Alternate tightening of setscrews:

Step 1. Tighten “A” to ½ recommended torque value.

Step 2. Tighten “B” to recommended torque value.

Step 3. Tighten “A” to recommended torque value.

20. Re-install sheave and belts (see related instructions in Sections 4 ▶ ▶ and 5 ▶ as needed).
21. Dynamically rebalancing the fan assembly is recommended.

ABOUT THIS DEVICE

These bearings can be found mounted in various positions, over or under a horizontal support or on either side of a vertical support.

STANDARD PILLOW BLOCK BEARINGS

TOOLS REQUIRED

- Standard mechanic’s hand tools.
- Medium flat file.
- Torque wrench, 0 to 250 in.-lb. range.
- Hex (Allen) socket set for torque wrench.
- Plastic or brass hammer.
- Brass bar or pipe of proper size.

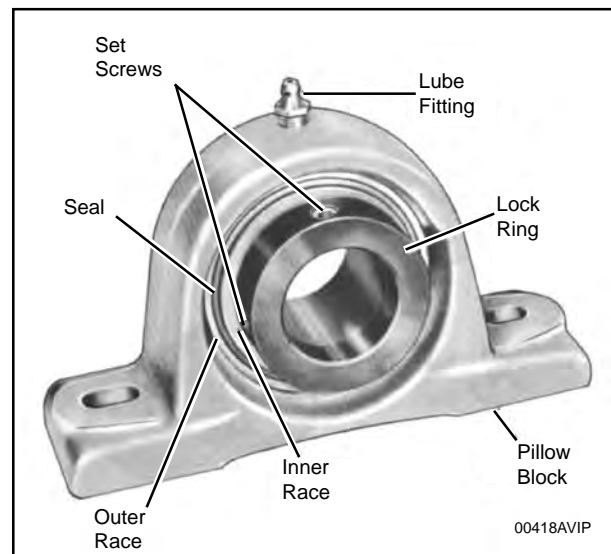
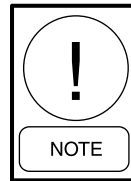


FIG. 5-12 – BEARING WITH SETSCREW TYPE LOCKING DEVICE

PROCEDURE

See Fig. 5-12

1. Remove belts (*see Section 4, "Adjustable Motor Base Operation"*). ►
2. Remove sheave and key.
3. Support fan wheel/shaft with cribbing, slings or jacks.
4. Clean shaft until it is shiny from bearings to ends of shaft.
5. File any burrs or set screw impressions from shaft.
6. Remove bolts holding bearings to bearing supports. Be sure to save any shims found between bearing housing and bearing support for re-use.
7. Remove setscrews from bearing locking collars (two on one side of each bearing, 90 degrees apart). Inspect and, if necessary, replace.
8. Remove bearings. If a bearing will not move, shine the shaft behind the bearing and bump the bearing toward the fan wheel. Use plastic hammer, brass bar or brass pipe. Then de-burr and shine the shaft where the bearing was previously located. Finally, pull the bearing off.
9. If the bearing sticks while pulling it off, don't force it. Clean, shine and de-burr the shaft where ever necessary.
10. Make sure the shaft is straight and not worn at the bearing location.
11. With the shaft and bearings clean, slide the new bearings onto the shaft with the setscrews facing away from the fan wheel.
12. Reassemble bolts, flat washers, lock washers, nuts and any shims found exactly as they were originally installed. There should be a flat washer under the bolt head and under the lock washer.
13. Lightly tighten each bolt so bearing position can be adjusted at each bearing.
14. Remove any temporary supports or blocking of fan wheel/shaft.
15. Slide the shaft in or out of the new bearings to center the wheel between the inlet cones on both sides of the fan. This is not critical, however it should be adjusted as close as possible by feeling the gaps between the cones and the edge of the wheel with the fingertips.
16. Install the setscrews in the drive side bearing but only tighten lightly.
17. Spin the fan wheel by hand to insure no rubbing will occur. Readjust if necessary. If the wheel rubs even though it is centered between the inlet cones, adjust by sliding bearing housing(s) on bearing support(s) until the wheel is spaced evenly at both inlet cones all around its circumference.
18. Install setscrews in opposite side bearing and tighten all setscrews to correct torque rating (*see Table 5-1*). ►
19. Drill and pin the bearings to the bearing supports. Use ¼" drill bit and ¼" roll pins. Apply in the area of the bolting flange on the housing base.

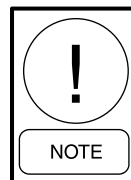
**Alternate tightening of setscrews:**

Step 1. Tighten "A" to ½ recommended torque value.

Step 2. Tighten "B" to recommended torque value.

Step 3. Tighten "A" to recommended torque value.

20. Re-install sheave and belts (*see related instructions in Sections 4 ►► and 5 ► as needed*).
21. Ensure bearings are properly lubricated (*see Section 4*). ►
22. Dynamically rebalancing the fan assembly is recommended.



A lock pin is inserted through the lubrication port on the "Sealmaster" brand bearing housing to prevent the bearing from spinning inside the housing. If a grease fitting (lube fitting) must be added or changed on bearings that utilize a lock pin under the fitting, it is important that the lock pin is in place when the fitting is installed. If an adapter or grease fitting of improper style or length is used, the lock pin may be either too tight or loose and can affect the alignment and re-lubrication of the bearing.

PILLOW BLOCK BEARINGS WITH ECCENTRIC LOCKING COLLAR

See Fig. 5-13 and 5-14

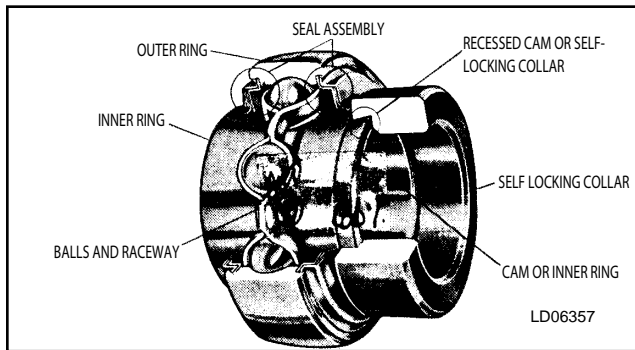


FIG. 5-13 – BEARING WITH ECCENTRIC CAM

TOOLS REQUIRED

- Standard mechanic’s hand tools.
- Medium flat file.
- Torque wrench, 0 to 250 in.-lb. range.
- Hex (Allen) socket set for torque wrench.
- Plastic or brass hammer.
- Brass bar or pipe of proper size.
- Slings or jack to support larger wheels/shafts.
- Center punch.
- Quarter inch drill bit.

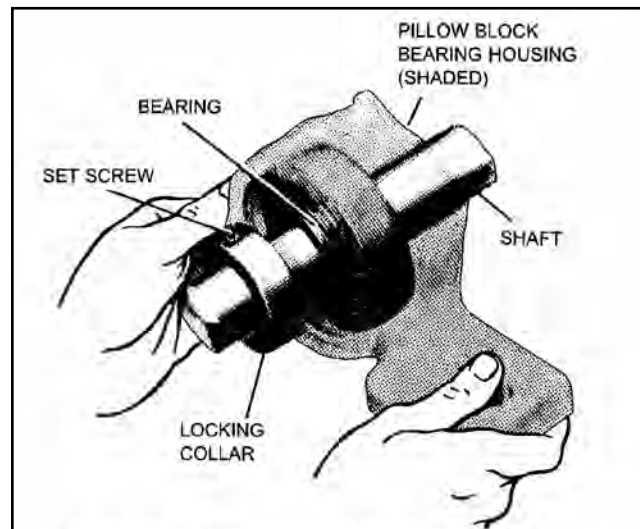
MATERIAL REQUIRED

- Exact replacement bearings (always in pairs).
- Steel wool, fine sanding cloth or fine emery cloth.
- Blocking or temporary support for fan wheel/ shaft.
- Grease (see Section 4 or paperwork supplied with new bearings). ▶
- Quarter inch roll pins (1 on each small bearing, 2 on each large bearing).

ABOUT THIS DEVICE

An eccentric locking collar is engaged to a cam on the bearing inner ring. Driven in the normal direction of shaft rotation, it grips the shaft with a positive binding action (see Fig. 5-14).

These bearings can be found mounted in various positions, over or under a horizontal support or on either side of a vertical support.



Do not apply excessive force to the bearing housing (pillow block or flange) when installing the bearing on the shaft.

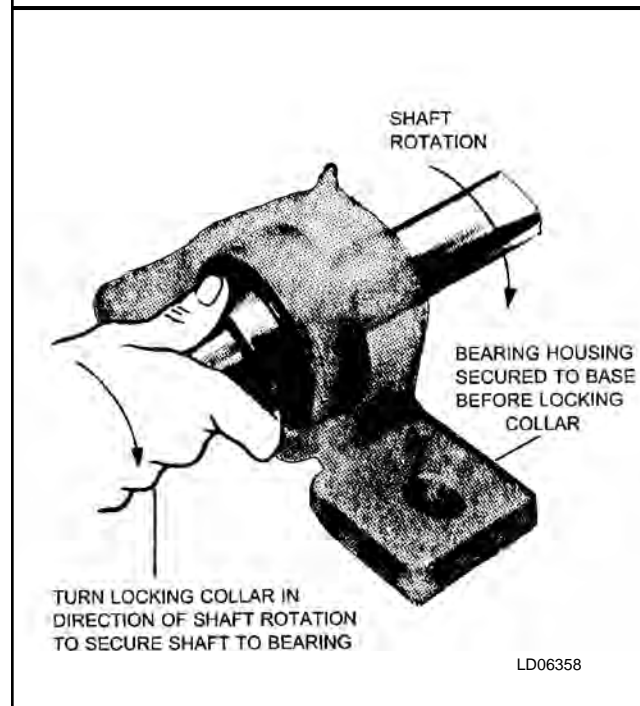


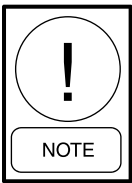
FIG. 5-14 – BEARING INSTALLATION – ECCENTRIC LOCKING COLLAR

PROCEDURE

See Fig's 5-13 & 5-14.

1. Remove belts (see Section 4, “Adjustable Motor Base Operation”). ▶
2. Remove sheave and key.

3. Support fan wheel/shaft with cribbing, slings or jacks.
4. Clean shaft until it is shiny from the bearings to ends of shaft.
5. File any burrs or other impressions from the shaft.
6. Remove the setscrew from each eccentric locking collar. Inspect and, if necessary, replace.
7. To remove the eccentric locking collars (self-locking collar). Hold a center punch in the drilled recess on the outer surface of the eccentric locking collar. Position the punch to drive the eccentric locking collar in the opposite direction of normal shaft rotation.
8. Give a sharp blow to the punch and the collar will release. Remove each eccentric locking collar in the same manner.
9. Remove bolts holding bearings to bearing supports. Be sure to save any shims found between bearing housing and bearing support for re-use.
10. Remove old bearings. If a bearing will not move, shine the shaft behind the bearing and bump the bearing toward the fan wheel. Use plastic hammer, brass bar or brass pipe. Then de-burr and shine the shaft where the bearing was previously located. Finally pull the bearing off.
11. If a bearing sticks while pulling it off, don't force it. Clean, shine and de-burr the shaft where ever necessary.
12. Make sure the shaft is straight and not worn at the bearing location.
13. With the shaft and bearings clean, slide the new bearings onto the shaft with the machined cam of the inner ring facing away from the fan wheel.
14. Reassemble bolts, flat washers, lock washers, nuts and any shims found exactly as they were originally installed. There should be a flat washer under the bolt head and under the lock washer. Replace the lock washers if they have taken a set making them nearly flat.
15. Lightly tighten each bolt so bearing position can be adjusted at each bearing.
16. Remove any temporary supports or blocking of fan wheel/shaft.
17. Slide the shaft in or out of the new bearings to center the fan wheel between the inlet cones on both sides of the fan housing. This is not critical, however should be adjusted as close as possible by feeling the gaps between the cones and the edge of the fan wheel with the fingertips.
18. Spin the fan wheel by hand to insure no rubbing will occur. Readjust if necessary. If the fan wheel rubs even though it is centered between the inlet cones, adjust by sliding bearing housing(s) on bearing support(s) until the wheel is spaced evenly at both inlet cones all around its circumference.
19. Tighten all bearing mounting bolts at this time.
20. Place each eccentric locking collar (self-locking collar) on the shaft with its cam adjacent to the machined cam of the bearing inner ring. Rotate the eccentric locking collar until it fits over the machined cam of the inner ring (*see Fig. 5-14*).
21. Holding the eccentric locking collar against the shoulder of the machined inner ring, rotate the eccentric locking collar in the normal direction of shaft rotation. The eccentric locking collar will grip the shaft as the cams engage. Rotate until firmly hand tight.
22. Hold a center punch in the drilled recess on the outer surface of the eccentric locking collar. Position the punch to drive the eccentric locking collar in the same direction as normal shaft rotation.
23. Lightly tap the center punch to lock the eccentric locking collar in the same direction as shaft rotation.
24. Install the setscrew in each eccentric locking collar and tighten to the correct torque rating (*see Table 5-1*). ►
25. Drill and pin the bearings to the bearing supports. Use ¼" drill bit and ¼" roll pins. Apply in the area of the bolting flange on the housing base
26. Re-install sheave and belts (*see related instructions in Sections 4 ► ► and 5 ► as needed*).
27. Ensure bearings are properly lubricated (*see Section 4*). ►
28. Dynamically rebalancing the fan assembly is recommended.



A lock pin is inserted through the lubrication port on the “Sealmaster” brand bearing housing to prevent the bearing from spinning inside the housing. If a grease fitting (lube fitting) must be added or changed on bearings that utilize a lock pin under the fitting, it is important that the lock pin is in place when the fitting is installed. If an adapter or grease fitting of improper style or length is used, the lock pin may be either too tight or loose and can affect the alignment and re-lubrication of the bearing.

SPLIT PILLOW BLOCK BEARINGS

TOOLS REQUIRED

- Standard mechanic’s hand tools.
- Medium flat file.
- Torque wrench, 20 to 300 ft.-lb. range.
- Plastic or brass hammer.
- Proper size spanner wrench.
- Brass bar or pipe of proper size.
- Slings or jack to support larger wheels/shafts.
- Quarter inch drill bit.

MATERIAL REQUIRED

- Exact replacement bearings (always in pairs).
- Steel wool, fine sanding cloth or fine emery cloth.
- Blocking or temporary support for fan wheel/ shaft.
- Rags or paper shop towels.
- Grease (see Section 4 or paperwork supplied with new bearings). ▶
- Quarter inch roll pins (1 on each small bearing, 2 on each large bearing).

ABOUT THIS DEVICE

This instruction is for the complete split pillow block bearing assembly replacement. If it is not necessary to replace the undamaged housing, eliminate the steps that follow for unbolting and bolting the base portion of the housing.

The temporary supports for the fan wheel/shaft used during bearing replacement must be flexible, as the assembly will have to be moved out of the base portion of the housing and back into it at some point during this process.

These bearings can be found mounted in various positions, over or under a horizontal support or on either side of a vertical support.

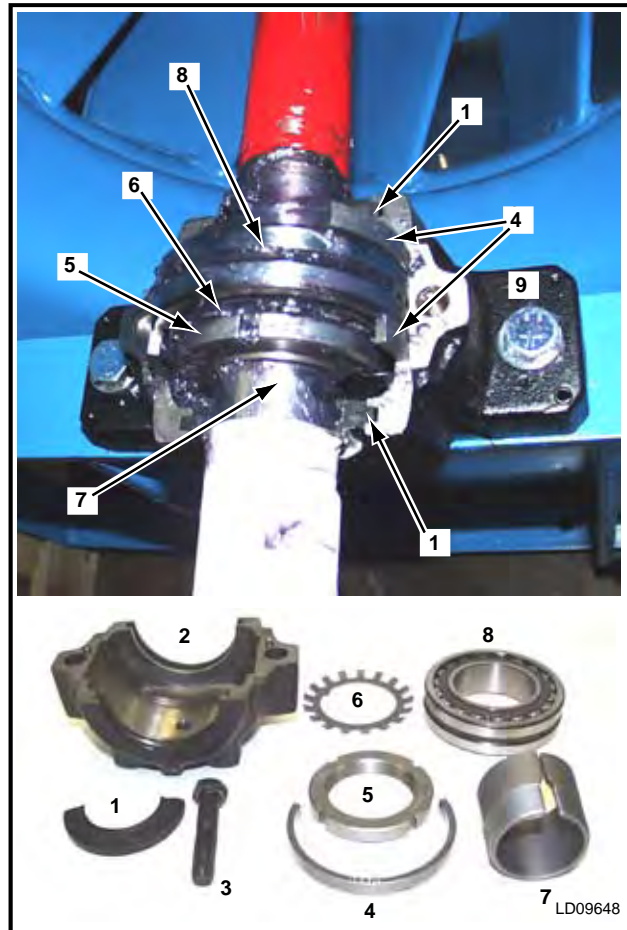


FIG. 5-15 – SPLIT BEARING

- | | |
|----------------------|-------------------|
| 1. Seal (4) | 6. Lock Washer |
| 2. Housing Cap | 7. Tapered Sleeve |
| 3. Cap Bolts (2) | 8. Bearing |
| 4. Locating Ring (2) | 9. Housing Base |
| 5. Lock Nut | |

PROCEDURE

See Fig. 5-15 & 5-16

1. Remove belts. (See Section 4, "Adjustable Motor Base Operation".) ►
2. Remove sheave and key.

3. Support fan wheel/shaft with cribbing, slings or jacks.
4. Clean shaft until it is shiny from bearings to ends of shaft.
5. File any burrs or impressions from shaft.

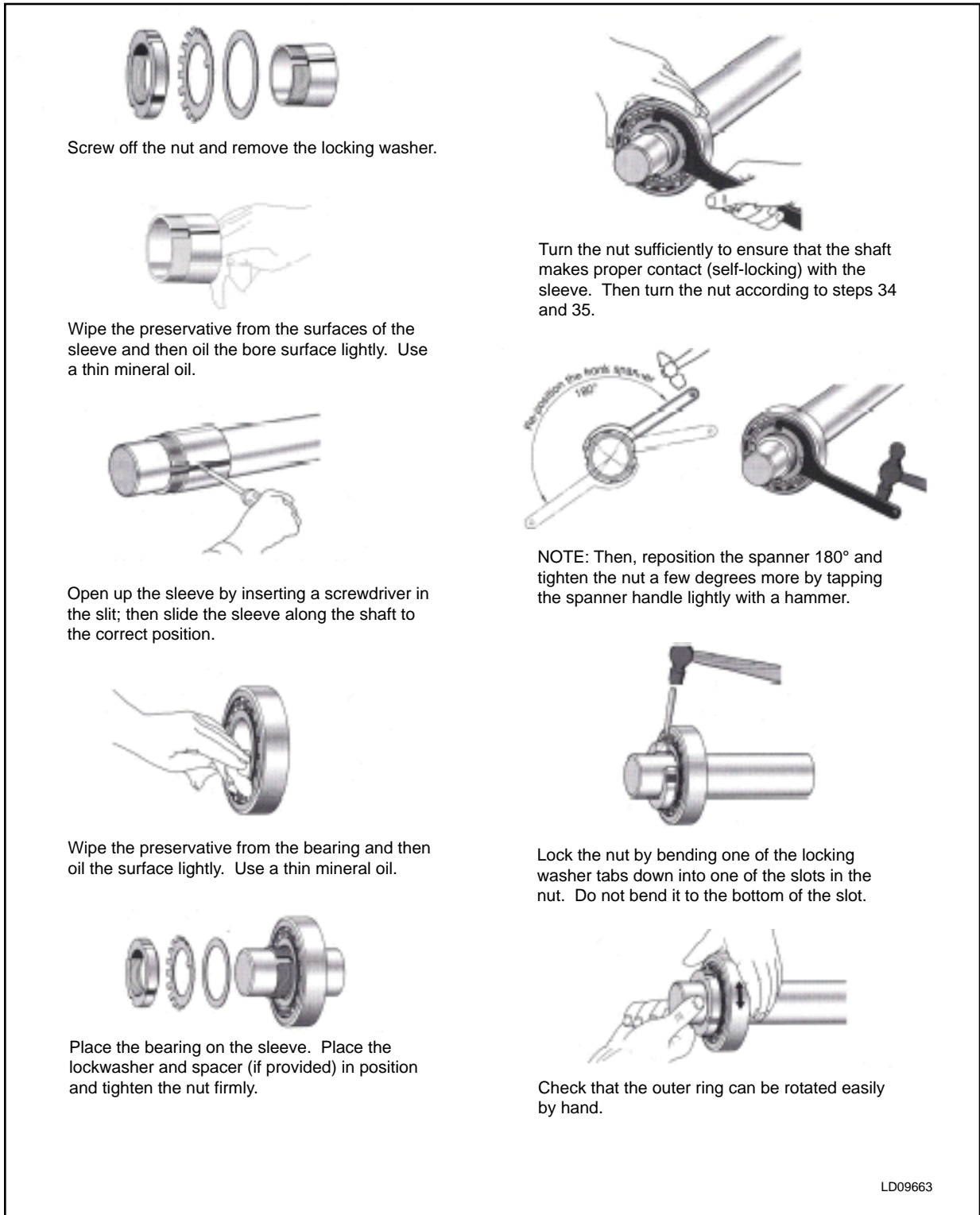
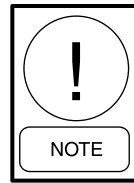


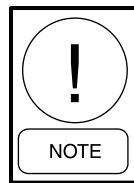
FIG. 5-16 – SPLIT BEARING ASSEMBLY

6. Remove the cap bolts from the split bearing housing.
7. Remove bearing housing cap. Tapping sideways with hammer may be necessary.
8. Move the supported wheel/shaft/bearing assembly out of the housing base.
9. Remove bolts holding the housing base to the bearing support. Remove the housing. If the housing is drilled and pinned to the support, pry the pin from the support. Be sure to save any shims found between the housing and bearing support for re-use.
10. Install the new housing base to the bearing support with bolt, flat washers, new lock washer and nut. There should be a flat washer under the bolt head and the lock washer. Make these hand tight so bearing position can be adjusted at each bearing later in this process.
11. Remove the bulk of the grease from the bearing and parts remaining on the shaft.
12. Find the bent lock washer tab inside one of the slots in the lock nut. Bend it perpendicular to the shaft, in line with the other tabs of the lock washer.
13. Hook proper size spanner wrench onto a slot in the lock nut for counterclockwise rotation.
14. Strike the spanner handle sharply with a hammer to break the nut free and remove the lock nut.
15. Remove the lock washer and spacer (if spacer present).
16. Using a brass bar and hammer bump the bearing off the tapered sleeve.
17. Open the sleeve by inserting a screwdriver in the slit, and then slip it off the shaft.
18. Make sure the shaft is straight and not worn at the bearing location.
19. De-burr, shine and clean the shaft.
20. Wipe preservative from tapered sleeve and bearing bore.
21. Place the tapered sleeve on the shaft with threaded end facing away from the fan wheel. Position the tapered sleeve for approximate location with respect to the required bearing centerline.



Light oil applied to the sleeve outside surface results in easier bearing mounting and removal.

22. Mount the bearing on the tapered sleeve with the large bore side first to match the taper of the sleeve. Push the bearing on hand tight and as straight as possible.
23. With the bearing hanging freely on the shaft, measure the ***UNMOUNTED, UNLOADED*** radial clearance by inserting progressively larger feeler blades the full length of the roller between the bottom most unloaded roller and the outer ring. ***RECORD THIS NUMBER.***
24. Apply the spacer, if provided, then the lock washer as illustrated. Fit the tab on the inside of the lock washer into a matching notch in the tapered sleeve.
25. Apply the locknut with the chamfered face toward the lock washer. ***TIGHTEN BY HAND ONLY.***



Apply lubricant on the face of the locknut where it contacts the lock washer for easier mounting and removal.

26. Apply grease to the rubber seals and place one in each new housing base already mounted.
27. Insert the locating rings into the housing base of the ***DRIVE SIDE BEARING HOUSING ONLY.*** Leave these rings out of the opposite side bearing to allow for shaft thermal expansion under load.
28. At this time, bring the status of both inboard and outboard bearing assemblies to this same level of completion.
29. Install the wheel/shaft/bearing assembly to the new housing base. It may be necessary to slide the bearing assemblies on the shaft to get both to line up with the proper cavity in the housings.
30. Center the wheel between the inlet cones on both sides of the fan. This should be adjusted as close as possible by feeling the gaps between the cones and the edges of the wheel with your fingertips.

31. Spin the fan wheel slowly by hand to insure no rubbing will occur. Readjust if necessary. If the wheel rubs even though it is centered between the inlet cones, adjust by sliding or shimming bearing housing(s) on bearing support(s) until the wheel is spaced evenly at both inlet cones all around its circumference.
32. Tighten the mounting bolts of the housing bases.
33. Begin tightening the locknuts of each bearing assembly using spanner wrench and hammer. Stop to check that the wheel is still centered.
34. While further tightening the locknuts, periodically stop to check the **UNLOADED** radial clearance. Since the bearing is mounted and now resting in the housing, insert the feeler blades between the **TOP MOST UNLOADED ROLLER** and the outer ring. *Spin the wheel before each measurement to ensure the rollers are positioned properly.* It may be necessary to lift the wheel/shaft/bearing assembly off the housing to complete the tightening process.
35. Continue tightening the lock nut until the **UNLOADED RADIAL CLEARANCE REDUCTION** (difference between clearance measured in step #34 and step #23) is within the specifications listed in Table 5-2.

| BORE DIAMETER D(MM) | | REDUCTION IN RADIAL INTERNAL CLEARANCE (IN.) | |
|------------------------|-------|--|---------|
| Over | Incl. | Min. | Max (1) |
| 24 | 30 | 0.0006 | 0.0008 |
| 30 | 40 | 0.0008 | 0.0010 |
| 40 | 50 | 0.0010 | 0.0012 |
| 50 | 65 | 0.0012 | 0.0015 |
| 65 | 80 | 0.0015 | 0.0020 |
| 80 | 100 | 0.0018 | 0.0025 |

36. Lock the nut by bending one of the lock washer tabs downward into one of the slots in the locknut. Do not bend more than a 45° angle. If one of the tabs does not line up with one of the slots, tighten the locknut until one does line up. **DO NOT LOOSEN THE LOCKNUT.**
37. Using your fingers, pack each bearing with grease by pressing measures of grease into the rollers. Rotate the bearing and shaft to access its entire circumference. Be sure to apply grease in this manner to both sides of each bearing so that all of the rollers are embedded in grease over their entire length.
38. Insert the remaining, greased seals into the groove in the housing caps and fill the space between the seal lips with grease.
39. Install each housing cap onto its respective housing base. Apply cap bolts and *tighten to correct torque value per Table 5-3.*

| CAP SCREW SIZE | TORQUE VALUES |
|----------------|---------------|
| 10 mm | 37 |
| 12 mm | 59 |
| 16 mm | 110 |
| 20 mm | 148 |
| 24 mm | 258 |

40. Drill and pin the bearings to the bearing supports. Use ¼" drill bit and ¼" roll pins. Apply in the area of the bolting flange on the housing base.
41. Re-install sheave and belts (*see related instructions in Sections 4 ►► and 5 ► as needed*).
42. Ensure bearings are properly lubricated (*see Section 4*). ►
43. Dynamically rebalancing the fan assembly is recommended.

SHEAVE REPLACEMENT AND ADJUSTMENT

FIXED PITCH SHEAVES

T.B. Woods with SURE GRIP® bushings.

TOOLS REQUIRED

- Standard mechanic’s hand tools.
- Medium flat file.
- Torque wrench, 0 to 250 in.-lb. range.
- Hex (Allen) socket set for torque wrench.
- Torque wrench, 0 to 150 ft.-lb. range.
- Standard 3/8" or 1/2" socket set
- Hammer

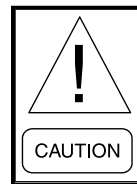
MATERIAL REQUIRED

- Fine emery cloth.
- Contact cleaner or mineral spirits

- Reverse Mounted - Thread cap screws into threaded holes in bushing. Hand tighten against sheave web.
4. Tighten each cap screw gradually and evenly in rotation to push the sheave off the taper of the bushing. Light tapping with hammer may be necessary.
 5. Remove or loosen setscrew from flange of bushing. Inspect and, if necessary, replace.
 6. Pull bushing off shaft. If the bushing will not come off, insert a screwdriver into the slit in the bushing.
 7. Remove key from keyway.

SHEAVE INSTALLATION

See Fig. 5-17



Do not use lubricants in this installation. Bushing and sheave mating surfaces must be clean and oil free.

1. Inspect the tapered bore of the sheave and the tapered surface of the bushing. Any paint, dirt, oil or grease **MUST** be removed.
2. Select the type of mounting (Fig. 5-18 or 5-19) that best suits your application.

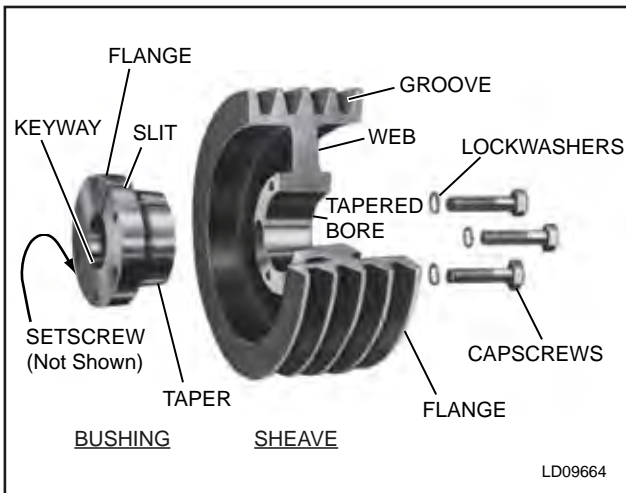


FIG. 5-17 – INSERTION OF CAPSCREWS

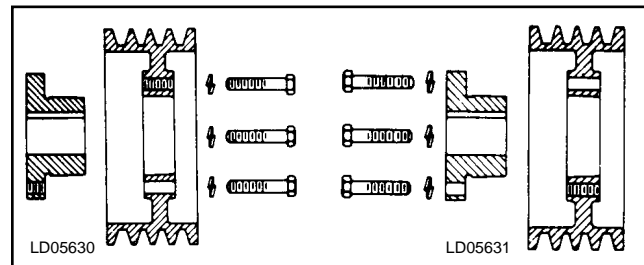


FIG. 5-18 – STANDARD MOUNTING

FIG. 5-19 – REVERSE MOUNTING

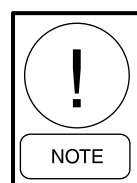
SHEAVE REMOVAL

See Fig. 5-17

1. Remove belts (see Section 4, “Adjustable Motor Base Operation”). ▶
2. Remove cap screws from bushing/sheave.
3. Separate sheave from bushing.
 - Standard Mounted - Thread cap screws into threaded holes in sheave. Hand tighten against bushing flange.

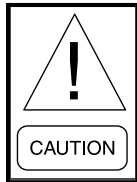
Standard Mounting

- a) Install shaft key.



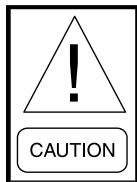
If key was furnished with bushing, you must use that key.

- b) Install bushing on clean shaft, flange end first. If bushing will not freely slide on the shaft, insert a screwdriver or similar object into the flange sawcut to act as a wedge to open bushings bore.



Excessive wedging will split the bushing.

- c) If using the setscrew, tighten it just enough to prevent the bushing from sliding on the shaft.

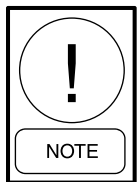


Do not tighten the setscrew to standard torque values at this time.

- d) Slide sheave into position on bushing, aligning the drill holes in the sheave with the tapped holes in the bushing flange.
- e) Loosely thread the caps crews with lock washers into the assembly. Do not use lubricant on the cap screws!

Reverse Mounting

- a) With large end of the out, slide sheave onto shaft as far as possible. Install shaft key.



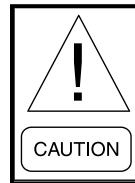
If key was furnished with bushing, you must use that key.

- b) Install bushing onto shaft so tapered end will mate with sheave.



Excessive wedging will split the bushing.

- c) If using the setscrew, tighten it enough to prevent the bushing from sliding on the shaft.



Do not tighten the setscrew to standard torque values at this time.

- d) Pull the sheave up on the bushing, aligning the drilled holes in the bushing flange with the tapped holes in the sheave.

- e) Loosely thread the cap screws with lock washers into the assembly. **Do not use lubricant on the cap screws!**

- 3. Using a torque wrench, *tighten all cap screws evenly and progressively in rotation to the torque value in Table 5-4.* There must be a gap between the bushing flange and sheave hub when installation is complete. Do not over torque! Do not attempt to close gap between bushing flange and sheave hub!

| TABLE 5-4 – CAPSCREW TORQUE VALUES FOR FIXED PITCH SHEAVES. | | |
|---|---------------------------|--------------------------------------|
| TAPERED BUSHING | SIZE & THREAD OF CAPSCREW | FT.-LBS. TO APPLY WITH TORQUE WRENCH |
| QT | 1/4 X 1 | 9 |
| JA | No. 10-24 | 5 |
| SH-SDS-SD | 1/4-20 | 9 |
| SK | 5/16-18 | 15 |
| SF | 3/8-16 | 30 |
| E | 1/2-13 | 60 |
| F | 9/16-12 | 110 |
| J | 5/8-11 | 135 |



The tightening force on the screws is multiplied many times by the wedging action of the tapered surface. If extreme tightening force is applied, or if a lubricant is used, bursting pressures will be created in the hub of the mating part.

- 4. Tighten all setscrews per Table 5-1 “Torque for Tightening Set Screws”. ►

SHEAVE ADJUSTMENT

1. Before belts are installed, *check alignment as described in Section 4.*
2. If adjustment is required, measure the space between the straight edge and the sheave.
3. Follow steps 2 through 5 under “*Sheave Removal*”.
4. Move the bushing in the proper direction the distance measured.
5. Proceed with “*Sheave Installation*” as listed above.

ADJUSTABLE PITCH SHEAVES

T.B. WOODS MODEL JVS.

Tools Required

- Standard mechanic’s hand tools.
- Medium flat file.
- Torque wrench, 0 to 250 in.-lb. range.
- Hex (Allen) socket set for torque wrench.
- Square.
- Straightedge.

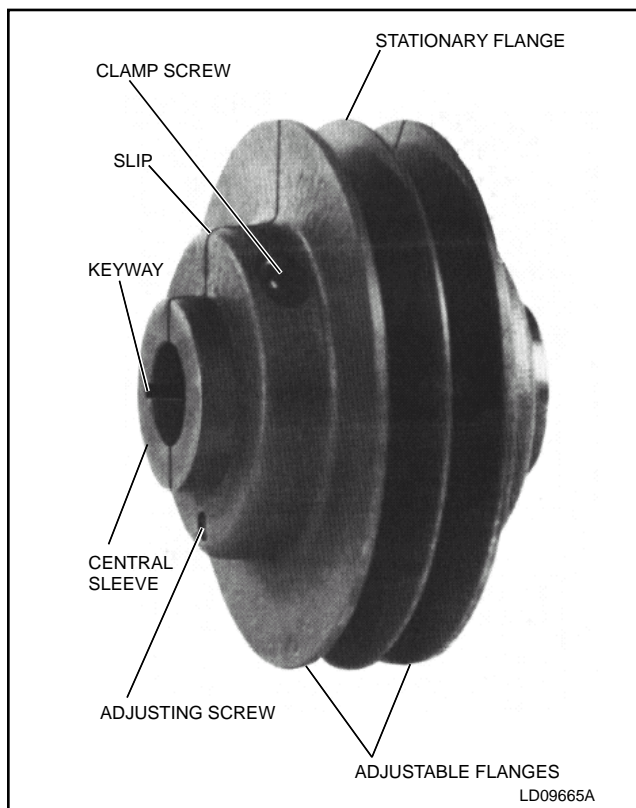


FIG. 5-20 – ADJUSTABLE PITCH SHEAVE (JVS)

Material Required

Fine emery cloth.

Sheave Removal

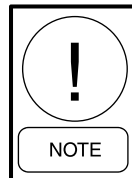
See Fig. 5-20

1. Remove belts (*see Section 4, “Adjustable Motor Base Operation”*). ►
2. Loosen both clamp screws. (Allen wrench).
3. Clean and remove any burrs from shaft from sheave to end.
4. Slide sheave off shaft. If tight, insert screwdriver into slit in central sleeve.

Sheave Installation

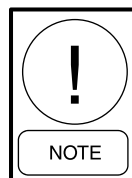
See Fig. 5-20

1. Loosen clamp screws on new sheave.
2. Slide the JVS sheave onto the shaft. The fan and motor sheaves should be placed on their respective shafts far enough to have shaft exposed just past its chamfer is possible. This is to facilitate proper alignment later in this process.



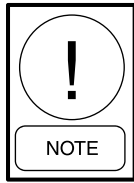
The central sleeve of this sheave is split at one end only. This end must be installed first as the split allows the sheave assembly to be secured to the shaft.

3. Adjust the sheave to the approximate pitch diameter desired. One turn of the adjusting screw will vary the pitch diameter .2 inches. Seven turns are required to adjust the sheave from minimum to maximum pitch diameter.



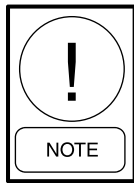
Slight finger pressure on the face of the adjustable flanges near the split (180 ° from adjusting screw) may be required to permit free and equal movement of flanges during pitch adjustments. Tipping and binding may otherwise occur.

4. Align the sheave with the companion sheave (see Section 4). ►



On adjustable sheaves of two or more grooves, if there is a difference of more than 1/8" between the width of the companion sheave and any adjustable pitch sheave, align per steps 5 through 8.

5. Alignment procedure for adjustable sheaves:
- Use a square and straight edge to align the center or stationary flange of the adjustable sheave with the center flange of the companion sheave.
 - Insure the shaft of the motor is parallel to the shaft of the fan.
6. Tighten the two clamp screws to the following torque values:
- a) JVS MODEL 130 - 160 in.-lbs. or 13 ft.-lbs.
 - b) All other JVS - 325 in.-lbs. or 27 ft.-lbs.



Be careful not to grasp flanges in such a manner as to cock them while tightening the clamp screws.

7. Install belts and properly tension (see Section 4).
8. Recheck alignment and speed.

Sheave Adjustment

1. To adjust pitch diameter it is important to loosen both clamp screws.
2. Remove belts.
3. Follow steps 3 through 8 in "Sheave Installation".

T.B. WOODS MODEL FHP.

Tools Required

- Standard mechanic's hand tools.
- Medium flat file.
- Torque wrench, 0 to 250 in.-lb. range.
- Hex (Allen) socket set for torque wrench.
- Square.
- Straightedge.

Material Required

Fine emery cloth.

Sheave Removal

See Fig. 5-21

1. Remove belts (see Section 4, "Adjustable Motor Base Operation"). ►
2. Loosen setscrews on adjustable flange(s) of sheave. (Allen wrench)
3. Screw the adjustable flange(s) open to expose and loosen the mounting setscrew in the central sleeve over the key.
4. Clean and remove any burrs from shaft from sheave to end.
5. Slide sheave off shaft.

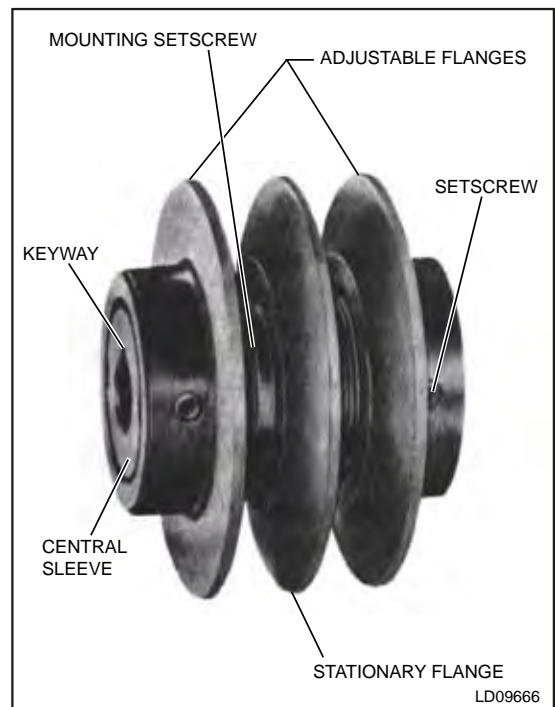
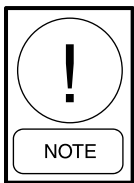


FIG. 5-21 – ADJUSTABLE PITCH SHEAVE (FHP)

Sheave Installation

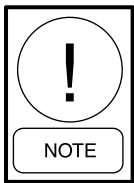
See Fig. 5-21

1. Loosen setscrews on adjustable flange(s) of new sheave (Allen wrench).
2. Screw the adjustable flange(s) open to expose and loosen the mounting setscrew in the central sleeve over the keyway.
3. Inspect the shaft and key for any nicks and burrs. Remove same and clean shaft.
4. Insert key in keyway.
5. Slide the new sheave onto the shaft with the mounting setscrew over the key and toward the motor.



The fan and motor sheaves should be placed on their respective shafts far enough to have shaft exposed just past its chamfer if possible. This is to facilitate ease of alignment later in this process.

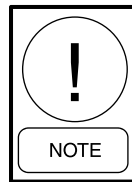
6. Align the adjustable sheave's stationary flange with the respective flange of the companion sheave. (See Section 4 on sheave alignment.)



On adjustable sheaves of two or more grooves, if there is a difference of more than 1/8" between the width of the companion sheave and any adjustable pitch sheave, align per steps 7 through 10.

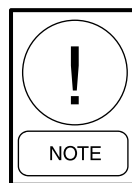
7. Alignment procedure for multiple groove adjustable sheaves:
 - a) Use a square and straight edge to align the center or stationary flange of the adjustable sheave with the center flange of the companion sheave.
 - b) Insure the shaft of the motor is parallel to the shaft of the fan.

8. Secure the adjustable sheave to the shaft by tightening the setscrew over the key to the proper torque value (see table 5-1). ►
9. Adjust the sheave flange(s) to the desired pitch diameter. Each turn of the flange changes the pitch diameter approximately .2 inches. Six turns are required to adjust the sheave from minimum to maximum for "A" or "B" belts and seven turns for 5V belts.



Both flanges of a 2-groove sheave MUST be adjusted evenly.

10. Lock the adjustable flange(s) in position by tightening the setscrew(s) to the proper torque value (see Table 5-1). ►



To prevent damage to central sleeve threads, the setscrews MUST be over one of the flat areas of the central sleeve. If the flange is not properly locked, the sheave will fail rapidly.

11. Install belts and properly tension (see Section 4). ►
12. Recheck alignment and speed.

Sheave Adjustment

1. Remove belts. (See Section 4, "Adjustable Motor Base Operation".) ►
2. To adjust pitch diameter loosen setscrew(s) on adjustable flange(s) of sheave.
3. Follow steps 9 through 12 above.

MOTOR REPLACEMENT

FAN MOTOR

TOOLS REQUIRED

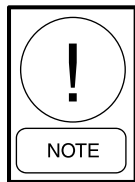
- Standard mechanic's and electricians hand tools.
- Torque wrench, 0 to 250 in.-lb. range.
- Flat screwdriver socket for torque wrench. Use with sizes 4, 6 & 8 connector.
- Hex Allen sockets, 3/16" and 1/4" for torque wrench for larger size connectors.

MATERIAL REQUIRED

- Correct size and quantity of insulated wire connectors.
- Correct size and quantity of flexible cable sleeves.

PROCEDURE

1. Shut off motor power and lock out.
2. Disconnect and tag power wires at motor terminals.
3. Loosen motor base-to-mounting-rail attaching bolts.
4. Remove and set aside belts.
5. Remove motor bracket hold down bolts.
6. Remove motor pulley and set aside.
7. Remove motor.



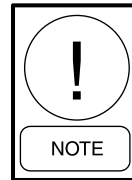
Connection box may have to be removed from motor body in order to fit motor through doorway. Some extreme cases may require removal of door and frame as well (see Section 5, "Door Replacement"). ▶

8. Install new motor. Reassemble by reversing steps 1 - 6. Be sure to reinstall multiple belts in their original position. Use a complete new set if required. Do not stretch belts over sheaves (see Section 4 "Sheave Alignment" ▶ and belt tensioning Section 4 "Belts"). ▶
9. Reconnect motor leads and restore power.

10. Check fan for proper rotation as described in Start-Up Check List.

• Motor Wire Connection Details

See Fig's 5-22 & 5-23



All field wiring must conform to the National Electrical Code (N.E.C.) and possible local codes that may be in addition to N.E.C.

Wire insulation *must be stripped in accordance with Table 5-5* for standard connectors. The wire insulation on a properly installed wire must be inside the insulated connector conductor port no less than 3/8". Apply the flexible cable sleeves only to the motor wires and not the power feed wires. *Refer to Table 5-5 for sleeve and connector part numbers and cable strip lengths.* Pressure screws must be secured at the torque value corresponding to the wire size and connector size shown in Table 5-6. The UL listing is for stranded wire only, AL/CU 600V max.

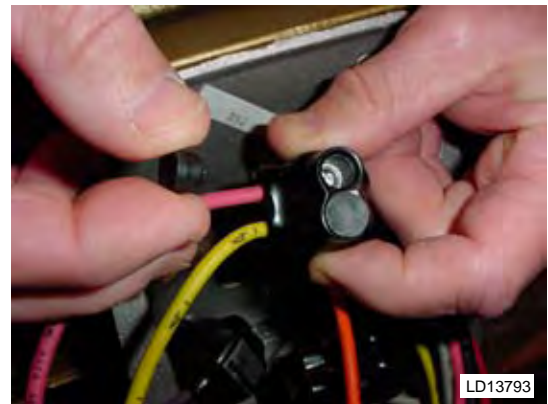


FIG. 5-22 – ASSEMBLY OF CONNECTORS



FIG. 5-23 – MOTOR WIRE CONNECTIONS

TABLE 5-5 – CONNECTORS & SLEEVES WITH STRIP LENGTHS

| Motor Voltage | HP | Wire Connector | | Flexible Cable Sleeve | | Strip Length |
|---------------|----------------------|----------------|-----|-----------------------|-----|--------------|
| | | Part Number | QTY | Part Number | QTY | |
| 200/208 | 1, 1.5, 2, 3 | 025-39042-001 | 3 | | | |
| 200/208 | 5 | 025-39042-003 | 3 | | | |
| 200/208 | 7.5 | 025-39043-001 | 4 | 025-39049-001 | 3 | .689" |
| 200/208 | 10 | 025-39043-001 | 4 | 025-39049-001 | 3 | .689" |
| 200/208 | 15 | 025-39043-001 | 3 | 025-39049-001 | 3 | .689" |
| 200/208 | 20 | 025-39043-001 | 3 | 025-39049-002 | 3 | .875" |
| 200/208 | 25 | 025-39044-002 | 3 | 025-39049-002 | 3 | .875" |
| 200/208 | 30 | 025-39044-002 | 3 | 025-39049-003 | 3 | .875" |
| 200/208 | 40 | 025-39044-002 | 3 | 025-39049-004 | 3 | .875" |
| 230/240 | 1, 1.5, 2, 3 | 025-39042-001 | 4 | | | |
| 230/240 | 5, 7.5 | 025-39042-003 | 4 | | | |
| 230/240 | 10 | 025-39042-003 | 1 | | | |
| | | 025-39044-001 | 3 | 025-39049-001 | 3 | .689" |
| 230/240 | 15 | 025-39043-001 | 3 | 025-39049-001 | 3 | .689" |
| 230/240 | 20, 25 | 025-39043-001 | 3 | 025-39049-002 | 3 | .875" |
| 230/240 | 30, 40 | 025-39044-002 | 3 | 025-39049-003 | 3 | .875" |
| 230/240 | 50 | 025-39044-002 | 4 | 025-39049-004 | 3 | .875" |
| 460 | 1, 1.5, 2, 3, 5, 7.5 | 025-39042-001 | 6 | | | |
| 460 | 10 | 025-39042-003 | 6 | | | |
| 460 | 15 | 025-39042-003 | 6 | | | |
| 460 | 20, 25, 30, 40 | 025-39043-001 | 6 | 025-39049-001 | 3 | .689" |
| 460 | 50 | 025-39043-001 | 6 | 025-39049-002 | 3 | .875" |
| 460 | 60, 75 | 025-39043-002 | 6 | 025-39049-003 | 3 | .875" |
| 460 | 100 | 025-39043-003 | 6 | 025-39049-004 | 3 | .875" |

TABLE 5-6 – TORQUE CHART - TIGHTENING TORQUE IN INCH POUNDS

| WIRE SIZE | CONNECTOR SIZE | | | | | |
|-----------|----------------|-----|-----|-----|-----|----|
| | 500 | 350 | 250 | 3/0 | 1/0 | #4 |
| 4/0 | 250 | 250 | 250 | | | |
| 3/0 | 250 | 250 | 250 | 250 | | |
| 2/0 | 180 | 180 | 180 | 180 | | |
| 1/0 | 180 | 180 | 180 | 180 | 180 | |
| #3-#1 | 150 | 150 | 150 | 150 | 150 | |
| #4-#6 | 110 | 110 | 110 | 110 | 100 | 45 |
| #8 | | | | | 75 | 40 |
| #10-#14 | | | | | 35 | 35 |

MOTOR REPAIR

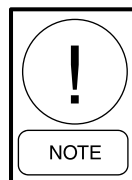
TOOLS REQUIRED

Standard mechanic’s and electricians hand tools.

MATERIALS REQUIRED

Correct parts for the application.

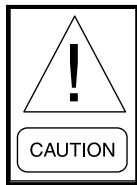
(See Form 102.20-RP1.) ►



Before replacing motor bearings, get authorization of motor manufacturer's representative if within standard warranty period or by Product Service if within extended warranty period.

COIL REPLACEMENT

To determine if a coil has right or left connections, face the unit from the air inlet section (see Fig. 5-24).



Always lightly flow dry nitrogen through tubing being brazed when in refrigeration system.

Inspect the coils for cleanliness. If necessary, hose the coils down with a low pressure water hose or low-pressure air.



In no case should the piping joints be heated for unswearing while refrigerant is within the coil. Dangerous pressures and gases can result.

TOOLS REQUIRED

- Screw gun with #3 Phillips bit.
- Scraper.
- Broad, thin pry bar.
- Power cords as required.
- Auxiliary lighting as required.
- Awl.
- Coil fin comb or fin straightener.
- Pipe wrenches of appropriate sizes.
- Brazing/soldering equipment if DX coil.
- Refrigerant reclaim equipment if DX or condenser coil.
- Standard mechanics tool kit.
- Lifting equipment (crane, fork lift, straps, dolly, roof cart, etc.).

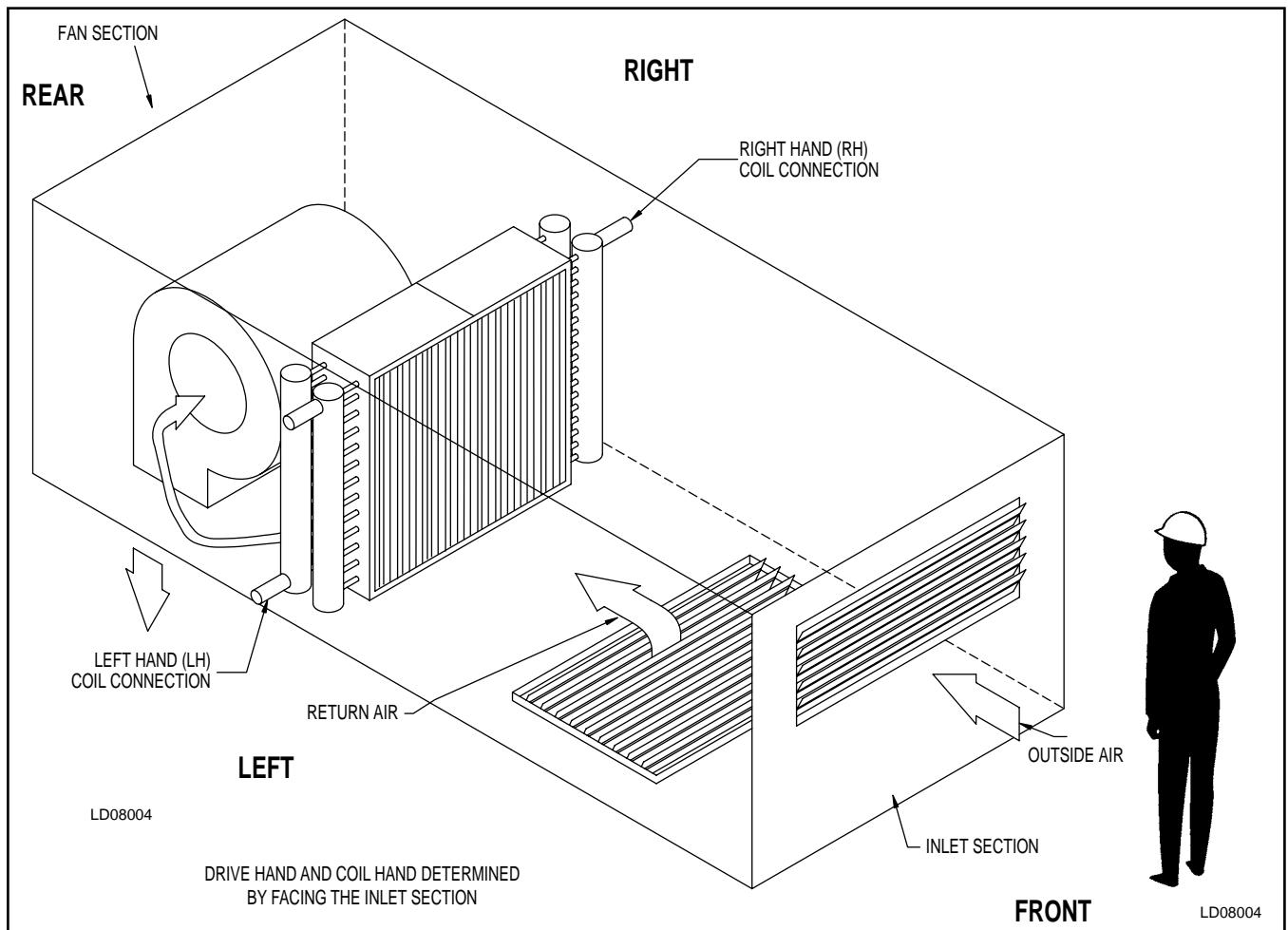


FIG. 5-24 – DETERMINING LEFT - OR RIGHT-HAND COIL CONNECTION / DRIVE SIDE

- Lifting lugs for large coils or difficult work locations. Lifting lugs can be ordered from Baltimore Parts. Contact BPC-Airside for part number. Must provide number of rows deep in order to obtain correct size lugs.

MATERIALS REQUIRED

- Roof or floor protection materials.
- Replacement gasket for coil mounting P/N 010-02917-000.
- Replacement screws for coil mounting P/N 021-12917-000.
- Replacement gasket for coil access panel P/N 028-11778-000.
- Replacement screws for coil access panel P/N 021-17722-000.
- Replacement gasket for indoor coil panel P/N 028-11960-000.
- Piping needs as required for specific connections.
- Caulk, P/N 013-03317-050 or 013-03317-040 for outdoor units with champagne paint.
- Heavy cardboard covering for coil fin surface.
- Duct tape.



• **Cleaning materials including microbial disinfectant.**

PROCEDURE

1. Shut down and lock out unit fan(s).
2. Shut off and lock out piping to coil(s).
3. For DX coils pump refrigerant into condenser, valve off and lock out associated condenser components.
4. Lay down roof or floor protection material at work areas.



5. DO NOT STAND INSIDE DRAIN PAN. IAQ EFFECTIVENESS WILL BE COMPROMISED.

6. Remove content of coil(s) safely in regard to personnel and environment. Usually refrigerant can be pumped into condenser, however if refrigerant remains in the coil being replaced, reclaim it per procedures and licenses according to current, applicable laws.
7. Disconnect piping from coil(s).
8. Remove coil access panel.
 - On outdoor units a removable panel is usually on opposite side of unit from pipe connections. This panel is installed with a dry gasket in order to be removable. *If other panels are to be removed, see Section 5 “Panel Replacement” for specific tools, material and procedures.*
 - ▶
 - On indoor units all panels are installed with a dry gasket in order to be removable.
 - If the panel on the piping side is to be removed to access the coil, piping will have to be removed instead of just disconnected. The reassembly procedure will also be slightly different (*see step 25 of this procedure*).
9. Remove any components, devices or sensors attached to coil, frame or intermediate drain pan. This may include another coil.
10. Remove any components, devices, sensors, filters or frames as needed to access coil mounting screws in bulkhead on air entering side of coil.
11. Remove coil mounting screws found securing coil frame to bulkhead. Be sure coil will not tip over.
12. Remove and save rubber grommets from coil connectors.
13. Remove any extended coil drain and vent piping or fixtures.

14. Large coils can be separated top and bottom by removing bolts from splice piece on coil end sheets and intermediate drain pan from coil air leaving side.
15. Large coils may be handled best with addition of lifting lugs.
16. Slide coil out of unit to cribbing, dolly, forklift, roof cart, etc.
17. Install coil lifting lugs if applicable.
18. For crane lift use professionals who will rig coils without damage to coil frames or surfaces.
19. Take necessary precautions in moving heavy objects across roof or flight over people and property.
20. Remove coil from workspace.



21. Clean drain pan, all panels and parts adjacent to coil area and areas wetted by condensation. Use a microbial disinfectant and cleaner or in combination (see also Section 4 “Coil Cleaning Procedure”). ►

22. Check gasket for coil mounting on coil bulkhead. Replace if damaged.
23. Cover new coil fin surface on both sides of coil with heavy cardboard or similar material to protect from damage.
24. Locate replacement coil at workspace.
25. Slide coil into unit using caution not to damage coil supports, coil bulkhead, drain pan, etc.
26. If the panel on the piping side was removed to access the coil, the procedure is the same except reassembly will be in a slightly different order in regards to the panel. The coil will be placed in its final position and anchored; then the panel will be put on over the coil connectors. Before fastening the panel in place, work the grommets into the holes around the coil connectors. Then fasten the panel in place.
27. Guide coil connectors through holes in panel on piping side of unit. Stop short of the final position.
28. Install rubber grommets onto coil connectors.
29. Proceed to move coil guiding connectors and until coil is in final location.
30. Work the grommets into the holes around the coil connectors.
31. Make sure the coil is in the proper mounting position against the gasket on coil bulkhead.
32. Reinstall screws to attach coil frame to bulkhead.
33. Be sure coil and bulkhead will not allow air to bypass coil. Seal with caulk if necessary. This material requires 3 hours to set.
34. Reinstall all components, sensors, frames, pans, filters, etc., which were removed previously inside unit.
35. Check alignment of coil connectors to existing pipe connections. Coil connectors on copper headers may be adjusted slightly by moving carefully and gradually without causing damage or leaks. This may be necessary because the connectors may get bumped, pushed or pulled slightly out of position.
36. Reconnect all piping, test for leaks and charge systems.
37. Remove heavy cardboard or other material previously installed on new coil as protection for fins. Inspect fins for deformation and repair with a fin comb or fin straightener.
38. Check gasket for coil access panel, replaced if damaged.
39. Reinstall coil access panel.
40. Clean up inside and outside of unit. Especially check for screws or other sharp objects left on roof surface.
41. Put unit back into operation per facility requirements. Be sure if caulk was used, that it has had time to set up to avoid creating air leaks.

DOOR REPLACEMENT**TOOLS REQUIRED**

- Standard mechanic's hand tools.
- Scraper.
- Spacers.

MATERIALS REQUIRED

- Correct parts for the application (*see Form 102.20-RP1*). ►
- Neoprene Gasket, P/N 028-11873-010

PROCEDURE

See Fig. 5-25

1. To prevent damage during removal, close and latch doors. Remove as complete Door/Frame Assemblies. On outdoor units, allow butyl tape to properly release by removing Door/Frame Assembly slowly. Failure to do so may result in damage to frame.

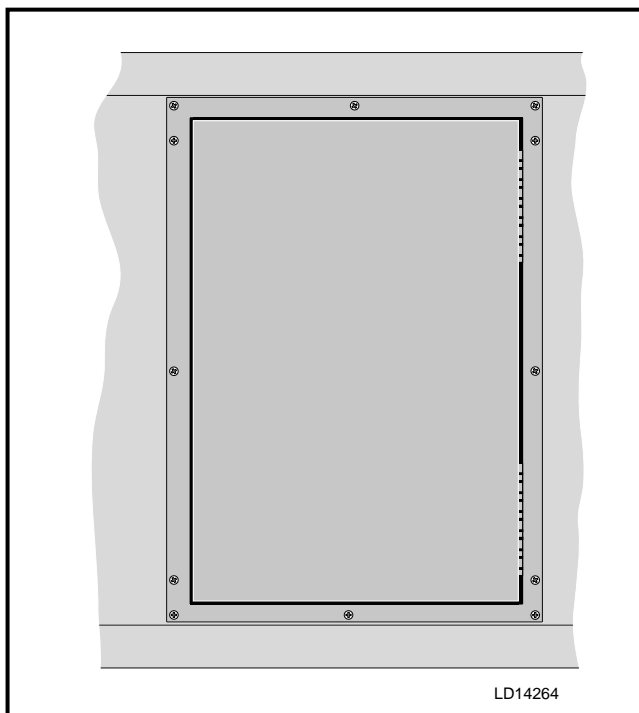
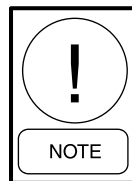


FIG. 5-25 – DOOR REPLACEMENT

2. Before installing Door/Frame Assembly, remove old gasket material from raceways and panels at mounting areas.
3. Apply new gasket material to back of frame along the outer edge. Use neoprene gasket, P/N 028-11873-010.



New door assemblies are provided with plastic spacers to maintain proper alignment.

4. Install new door assembly with door closed and latched with spacers in place.
5. Then, install screws in hinge side of doorframe.
6. Finally, install screws in top, bottom and latch sides of doorframe. Once door assembly is installed, remove plastic shipping spacers from between door and doorframe.
7. Check operation of door with unit off.
8. Check for obvious air leakage with air unit in operation.

DOOR GASKET REPLACEMENT

This procedure tells how to replace foam gaskets onto doors using a mitered corner (units mfg. before Jan. 2006) and a but corner joint (units mfg after door re-design, Jan 2006).

TOOLS REQUIRED

- Standard mechanic's hand tools.
- Scraper.
- Caulk gun.

MATERIALS REQUIRED

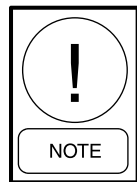
- Door gasket material (order by measuring exact size of door panel height and width).
- One tube caulk (sealant), P/N 013-03317-050 aluminum gray or 013-03317-040 for outdoor units with champagne paint.

PROCEDURE

See Fig. 5-26

REMOVE OLD GASKET

Using fingers or pliers, grasp the old gasket at a point near the center of any horizontal or vertical frame component, and pull straight out of the frame, working from the center toward the corners. Repeat on each of the four sides of the gasket.



Do not start at a corner! Starting at a corner may cause a portion of the gasket to tear away and remain inside the narrow groove in the aluminum doorframe. Any such material must be removed before the new gasket is installed. The old gasket MUST be COMPLETELY REMOVED.

REMOVE SEALANT

It is necessary to clean up any excess factory-applied corner sealant, which might prevent the new gasket from laying flat on the doorframe. Use a flat, rigid object such as a putty knife to scrape the surface of the frame where the new gasket will rest. Also, remove as much sealant as possible from inside the groove so that the new gasket will seat properly.



FIG. 5-26 – OLD STYLE DOOR WITH MITERED CORNER GASKET

INSTALL NEW MITERED GASKET (BEFORE JAN 2006)

1. Cut the end of the gasket at an angle of 40° through the top of foam to the stem (*see Fig. 5-27*).
2. Cut the stem back slightly so that the top of the stem is flush with the base of the gasket, and the barb end of the stem is cut back at a slight angle (*see Fig. 5-27*).

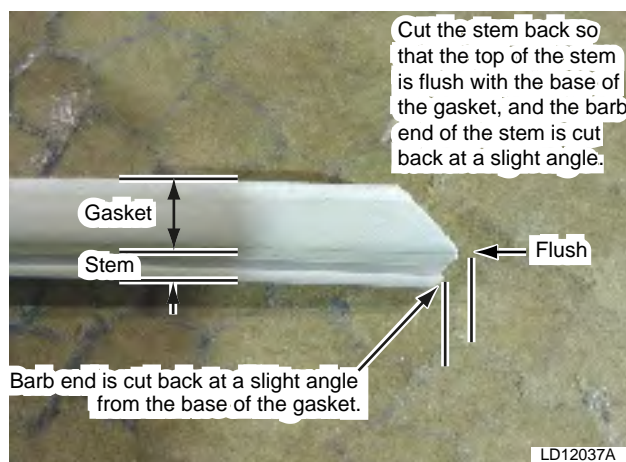
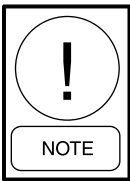


FIG. 5-27 – CUTTING END OF GASKET



The first corner notching is done prior to placement onto the door.

- Measure in 6" (+/- 1.0") from the top of the overlapping splice and mark the gasket where the first cut is to be made (see Fig. 5-28).

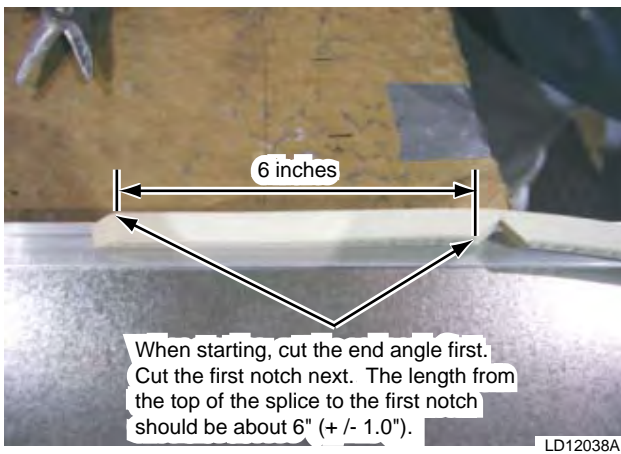


FIG. 5-28 – MARKING GASKET FOR FIRST CUT

- The first cut is about 2/3 to 3/4 of the way through the gasket. The cut should be about 40 degrees (see Fig. 5-29).

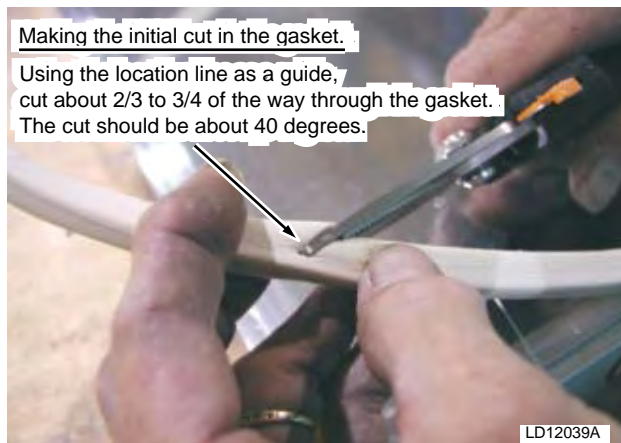


FIG. 5-29 – MAKING FIRST CUT ON GASKET

- The second cut is about 2/3 to 3/4 of the way through the gasket. The cut should be about 40 degrees. The total angle from the initial and second cut should be about 80 degrees +/- 5 degrees (see Fig. 5-30).

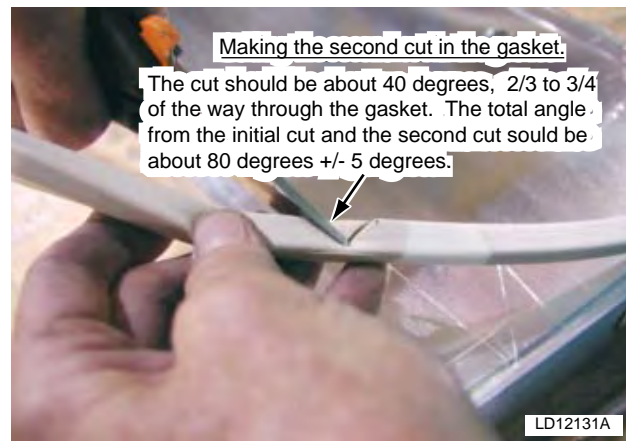


FIG. 5-30 – MAKING SECOND CUT ON GASKET

- Turn the gasket over, open the notch, and cut back the stem on both ends (see Fig. 5-31).



FIG. 5-31 – CUT BACK STEM

4. Apply the sealant to the area on the latch side where the overlapping splice will be.

- The sealant must be in the groove and surrounding area on the perimeter.
- The length of the sealant area is about 2" (see Fig. 5-32).



FIG. 5-32 – APPLY SEALANT TO OVERLAPPING SPLICE AREA

5. Apply sealant to the corner.
 - Sealant needs to fill the gasket grooves 1 to 1-1/2" out from the corner.
 - Sealant is also applied to the edge outside the grooves.
 - A liberal amount is also applied on the inside of the corner (see Fig. 5-33).

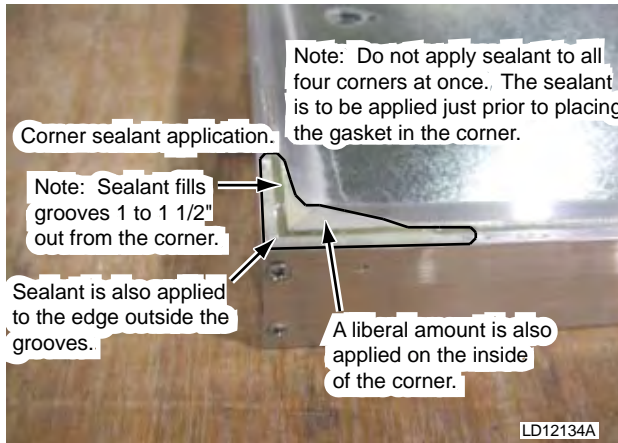
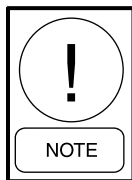


FIG. 5-33 – APPLY SEALANT TO CORNER



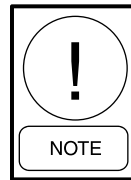
Do not apply sealant to all four corners at once. The sealant is to be applied just prior to placing the gasket in the corner.

6. Take the corner angle cut and place the end into the joint sealant.
7. Press the gasket into the gasket groove, to the corner, using a roller.
8. Insert sealant into the notched area (see Fig. 5-34).



FIG. 5-34 – PLACE ANGLE CUT IN CORNER AND APPLY SEALANT TO NOTCHED AREA

9. Fold the joint together and press the gasket into place.



Ensure that the mitered joint is completely closed, the two pieces are not offset, and it lays flat.

10. Using a roller, press the gasket into the gasket groove within 6" of the next corner.
11. Using a pen, mark the location for cutting the next corner.
 - Line up the edge of the gasket with the edge of the door.
 - Mark the gasket (both on the inside and outside edge of the gasket material) where the center of the miter joint on the aluminum doorframe perimeter is located (see Fig. 5-35).

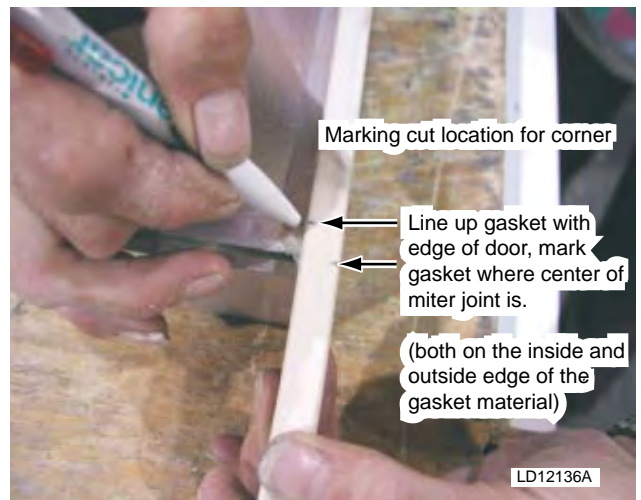


FIG. 5-35 – MARK LOCATION FOR CUTTING NEXT CORNER

12. Notch gaskets, apply corner sealant and place gaskets in remaining corners by repeating steps 3 through 10.
13. Roll the gasket to within six inches of the latch side overlap.
14. Lay the gasket next to the existing angle cut for the overlap.
15. Using a pen, mark the top of the gasket about 1 to 2 mm longer than the top of the “in place” gasket.

16. Mark the bottom of the gasket about 1 to 2 mm longer than the base of the “in place” gasket (see Fig. 5-36).

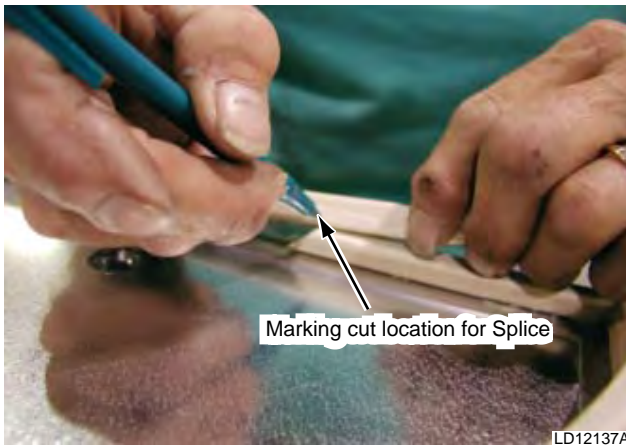


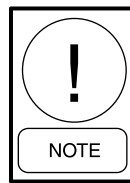
FIG. 5-36 – MARK GASKET FOR OVERLAP LOCATION

17. Cut the gasket at an angle using the two marks as a guide.
18. Apply sealant to the splice area.
 - Completely cover the cut edge of the “in place” gasket end.
 - Fill the gasket groove on the perimeter and surrounding area about 1" out from the base of the “in place” gasket (see Fig. 5-37).



FIG. 5-37 – APPLY SEALANT TO EDGE AND AROUND “IN PLACE” GASKET

19. Assemble the joint by placing the cut piece onto the “in place” gasket.
20. The cut piece of gasket must overlap by 1 to 2 mm.



Flush joints or gaps between pieces are not acceptable (see Fig. 5-38 for correct overlap).



FIG. 5-38 – OVERLAP CUT PIECE WITH “IN PLACE” GASKET

21. Apply sealant to the inside of the splice and along the bottom of the gasket in the splice area (minimum of 1" to both sides of splice at the base). See Fig. 5-39.

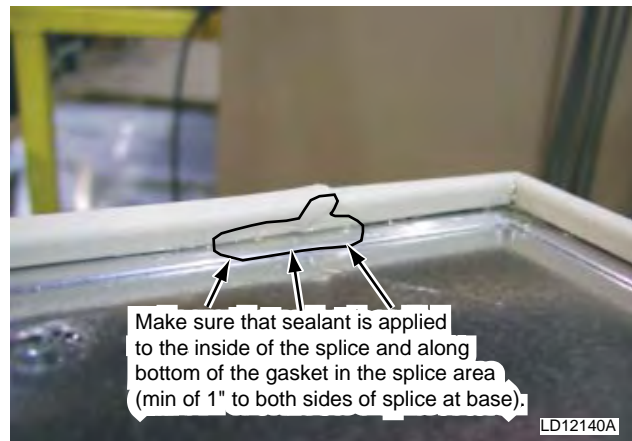


FIG. 5-39 – APPLY SEALANT TO SPLICE BASE

22. Inspect all corners for adequate sealant. The inside of the corners must have sealant on the gasket and door perimeter. Add sealant as needed (see Fig. 5-40).

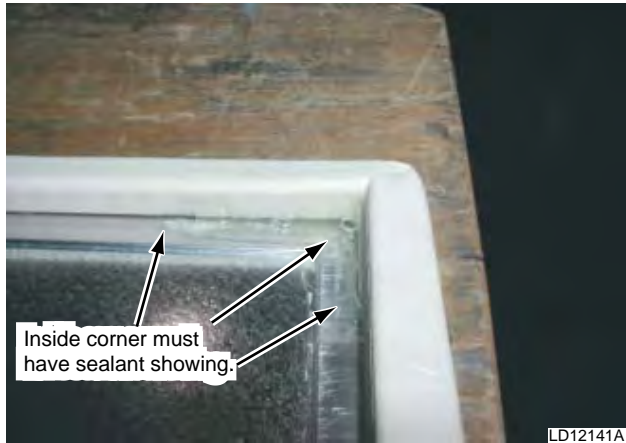
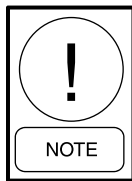


FIG. 5-40 – ENSURE ALL CORNERS HAVE ADEQUATE SEALANT

23. Set door aside



In order to keep from creasing the gaskets, store the doors gasket to gasket.

24. Repeat steps to install gaskets on additional doors. See Fig. 5-41 & 5-42 for examples of correct and incorrect mitered foam gasket corners.

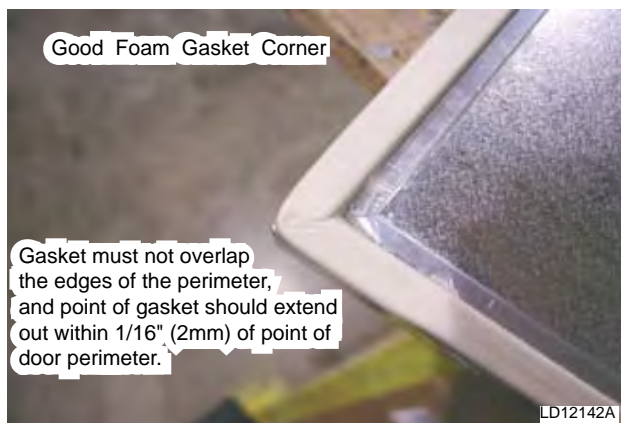


FIG. 5-41 – CORRECT MITERED FOAM GASKET CORNER

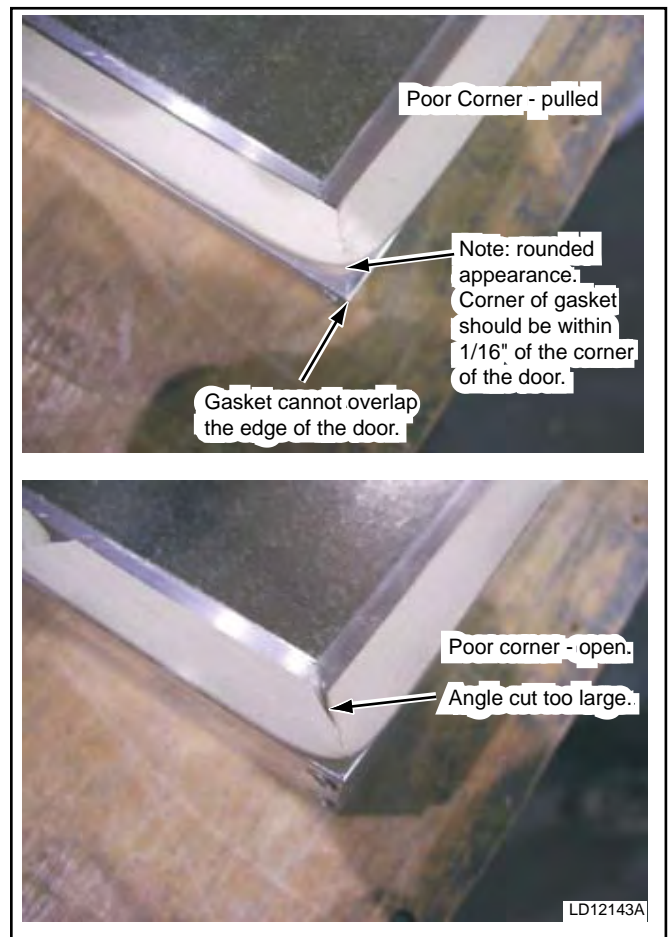


FIG. 5-42 – INCORRECT MITERED FOAM GASKET CORNER

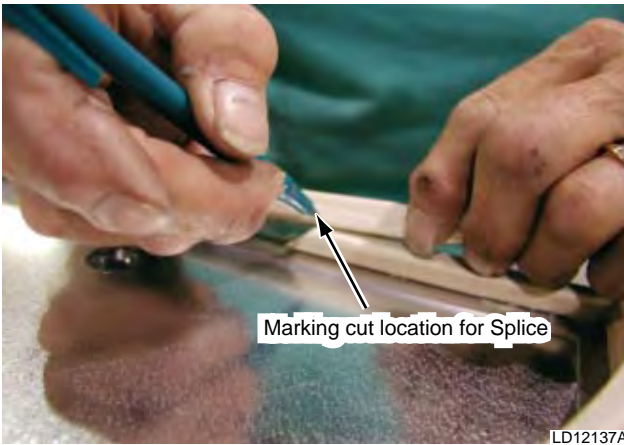
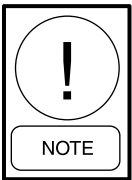


FIG. 5-43 – NEW STYLE DOOR WITH BUT CORNER JOINT GASKET (UNITS PRODUCED JAN 2006 THROUGH OCT 2008)

INSTALL NEW GASKET ON DOOR PRODUCED JAN 2006 THROUGH OCTOBER 2008)

1. Position the frame with the anti-compression leg up.
2. Cut a piece of gasket that will fit between the two verticals (+0, -2mm).



At some point in time, the gasket may come precut.

3. Remove 1/8" of the hard portion of the gasket, on both ends (see Fig.'s 5-44 thru 5-46).

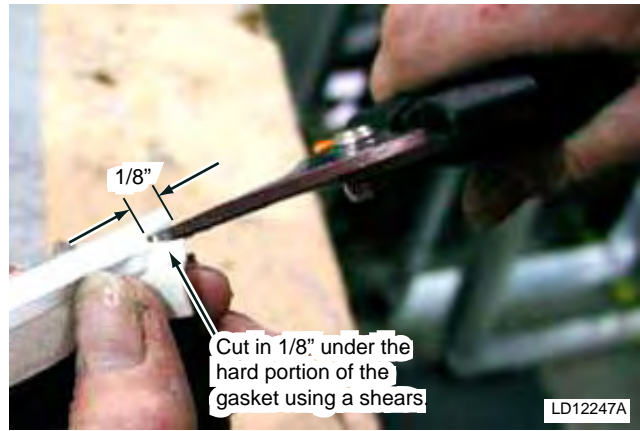


FIG. 5-44 – CUT IN 1/8" UNDER HARD PORTION OF GASKET.

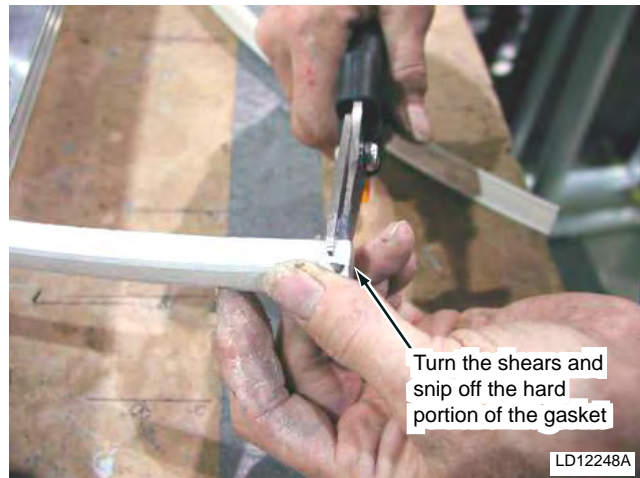


FIG. 5-45 – SNIP OFF HARD PORTION OF GASKET.

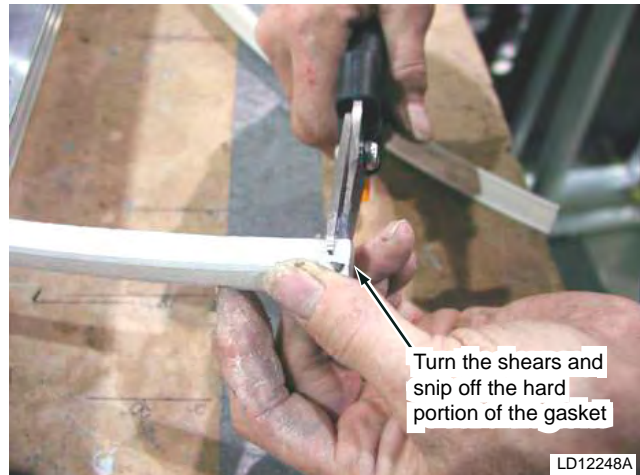
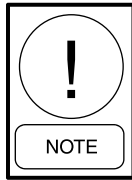


FIG. 5-46 – FINISHED CUT

4. Apply a continuous 1/8" diameter bead of sealant along the gasket attachment leg from just inside (3/8 to 1/2") the vertical anti-compression leg in one corner to the same location in the opposite corner (see Fig. 5-47).



The sealant can be applied to both horizontals at the same time as long as the gaskets are to be installed immediately.

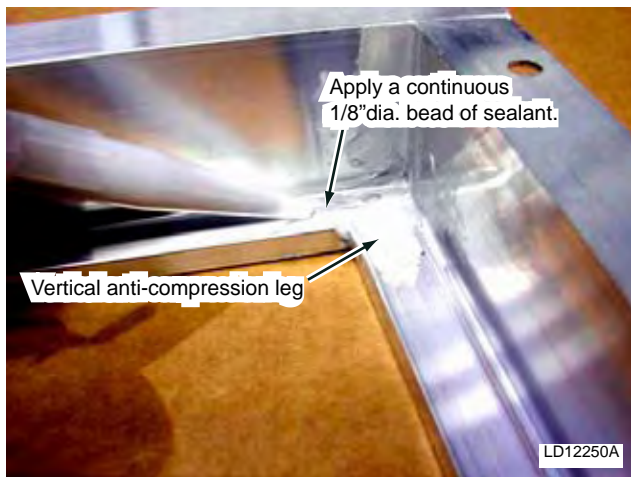
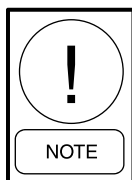


FIG. 5-47 – APPLY FIRST PIECE OF HORIZONTAL GASKET

5. Apply sealant from the edge of the vertical, out approximately 1-1/2" onto the horizontal. Make sure to fill the entire corner with sealant. Also apply sealant about 1/4" up the vertical wall (see Fig. 5-48).



Apply sealant to the corners immediately before the gasket is to be installed. Do not apply sealant to all four corners at once.

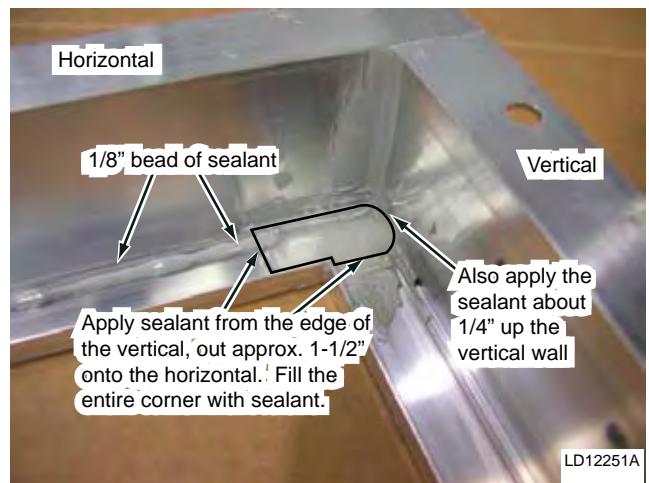
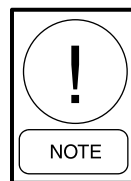


FIG. 5-48 – APPLY SEALANT IN CORNERS

6. Once the corner sealant is applied to both ends, the gasket is attached to one corner (see Fig. 5-49), and rolled in place (see Fig. 5-50).



Make sure that the gasket is completely snapped in place or leakage will occur. The horizontal gasket should extend the entire width of the opening (+0, -2 mm).

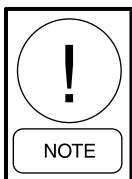


FIG. 5-49 – ATTACH GASKET TO ONE CORNER



FIG. 5-50 – ROLL GASKET TO OTHER CORNER

7. Repeat steps 2 thru 6 for the other horizontal.
8. Vertical gaskets require cuts as close to 90 degrees as possible.
9. The hard portion of the vertical gasket does not need to be cut back as in step 3.



At some point in time, the gasket may come precut.

10. Rough cut the gasket to approximately the same length as the opening between the horizontal frame pieces.
11. Trim one end of the gasket to 90 degrees, per step 8.
12. Apply sealant down the edge of the horizontal gasket and fill the area out 1" between the anti-compression leg and the wall of the vertical (*see Fig. 5-51*).

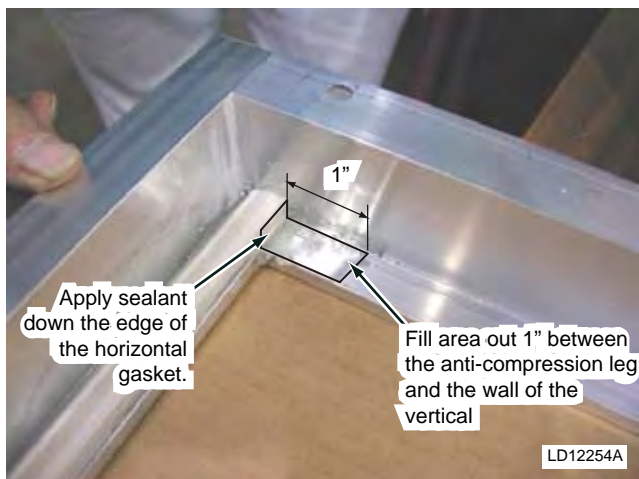


FIG. 5-51 – APPLY SEALANT FOR FIRST VERTICAL GASKET

13. Apply a modest amount of sealant to the gasket end which was trimmed in step 11 (*see Fig. 5-52*).



FIG. 5-52 – APPLY SEALANT END OF FIRST VERTICAL GASKET

14. Place the vertical gasket about 1/4 to 1/2" from the horizontal gasket, align the attachment pocket of the gasket over the gasket attachment leg of the extrusion, and snap the last inch of the gasket into place. Push the vertical into the side of the horizontal 1 to 2 mm. Sealant should ooze from the joint (*see Fig's 5-53 and 5-54*).

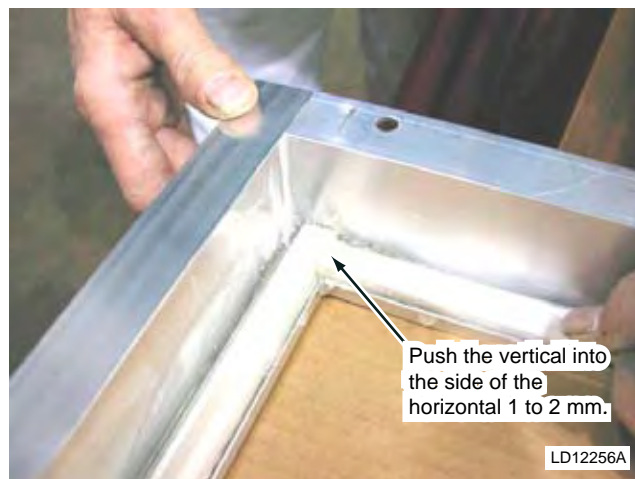
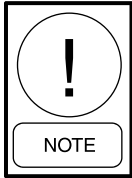


FIG. 5-53 – POSITION FIRST VERTICAL GASKET



FIG. 5-54 – GOOD VERTICAL TO HORIZONTAL BUT JOINT

- Roll the gasket in place to within 5 to 6" from the opposite end.



Make sure that the gasket is completely snapped in place or leakage will occur (see Fig. 5-55).

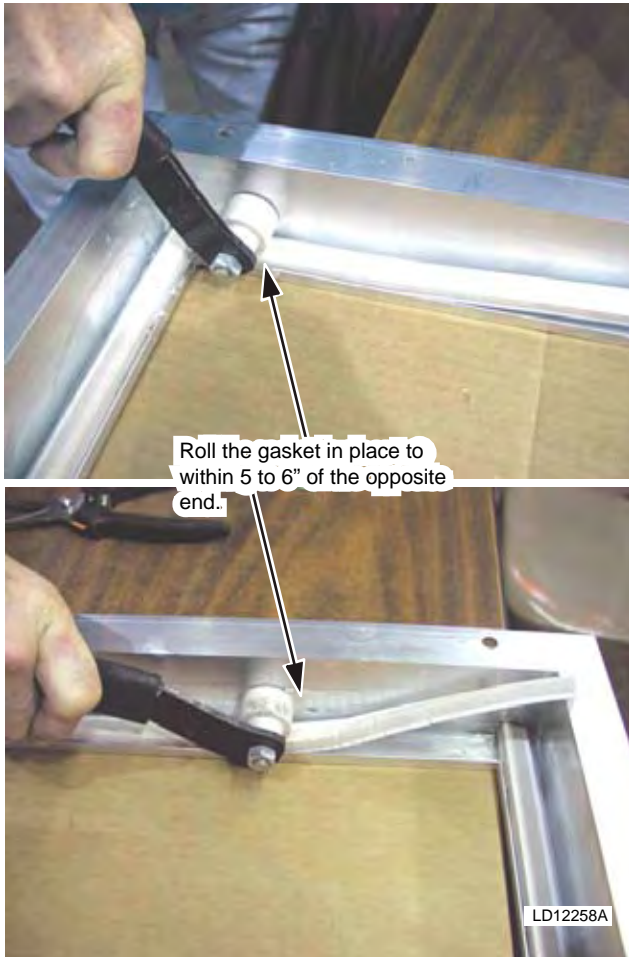


FIG. 5-55 – ROLL GASKET TO WITHIN 5 TO 6" OF OPPOSITE END

- Trim enough of the gasket off in order to allow the tail end to fit inside the frame (see Fig. 5-56).

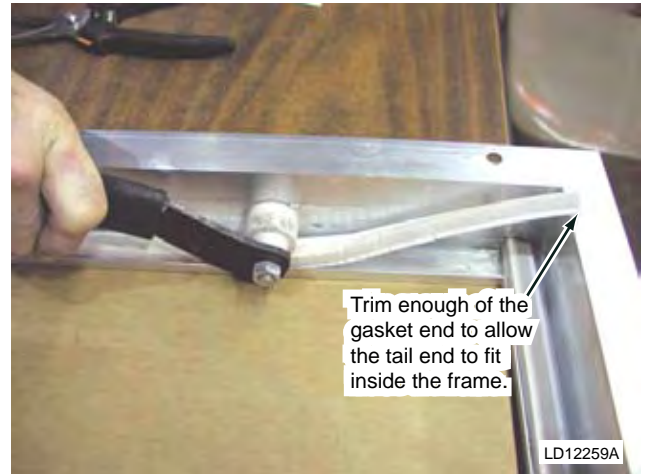


FIG. 5-56 – TRIM GASKET END

- Lay the vertical gasket across the horizontal gasket and place a mark 1 to 2 mm past the edge of the horizontal gasket (see Fig. 5-57).

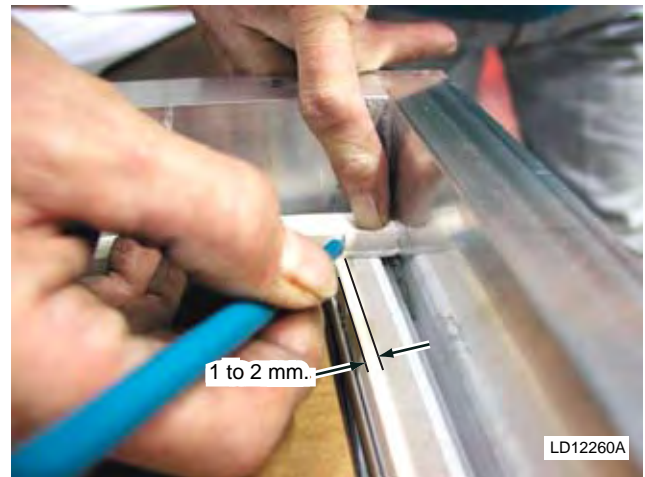


FIG. 5-57 – MARK VERTICAL GASKET

- Trim the end of the gasket to 90 degrees, per step 8.
- Apply sealant down the edge of the horizontal gasket and fill the area out 1" between the anti-compression leg and the wall of the vertical (see Fig. 5-51).

20. Place the vertical gasket about 1/4 to 1/2" from the horizontal gasket, align the attachment pocket of the gasket over the gasket attachment leg of the extrusion, and snap the last inch of the gasket into place. Push the vertical into the side of the horizontal 1 to 2 mm. Sealant should ooze from the joint (*see Fig's 5-58 and 5-59*).



FIG. 5-58 – POSITION VERTICAL GASKET

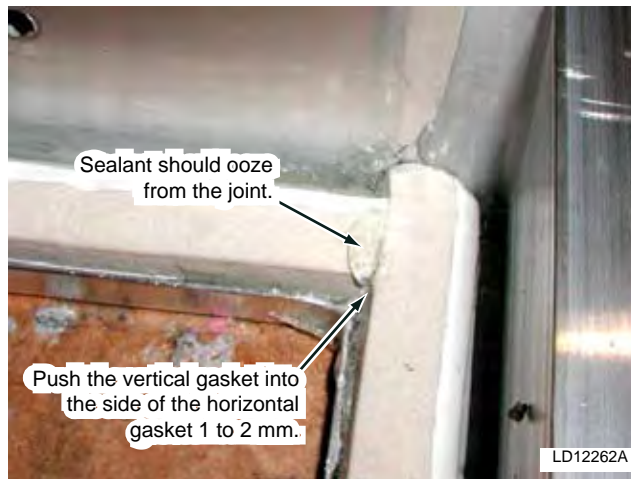


FIG. 5-59 – PROPER PLACEMENT OF VERTICAL TO HORIZONTAL GASKET

21. Roll the gasket into place. Secure the corner first as in Fig. 5-60 (roll into the corner). Once the corner is secured, roll out towards the opposite corner per Fig. 5-61.



FIG. 5-60 – ROLL VERTICAL GASKET INTO PLACE AND SECURE



FIG. 5-61 – ROLL TOWARDS OPPOSITE END OF VERTICAL GASKET

22. Using either a dry towel or one moistened in mineral spirits; wipe the excess sealant from the gasket and anti-compression leg area (*see Fig. 5-62*).

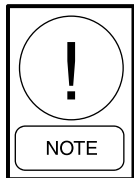


FIG. 5-62 – WIPE OFF EXCESS SEALANT

23. Repeat steps 8 thru 22 to place the gasket in the other vertical.
24. In the event that the gasket will not lay flat, place a clamp over the inside portion of the joint. The clamp needs to rest on the anti-compression legs (see Fig. 5-63).



FIG. 5-63 – APPLY CLAMP TO CORNER AS NECESSARY



Clamps must stay in place for a minimum of 10 minutes before removal.

25. See Fig's 5-64 and 5-65 for examples of unacceptable gasket joints.

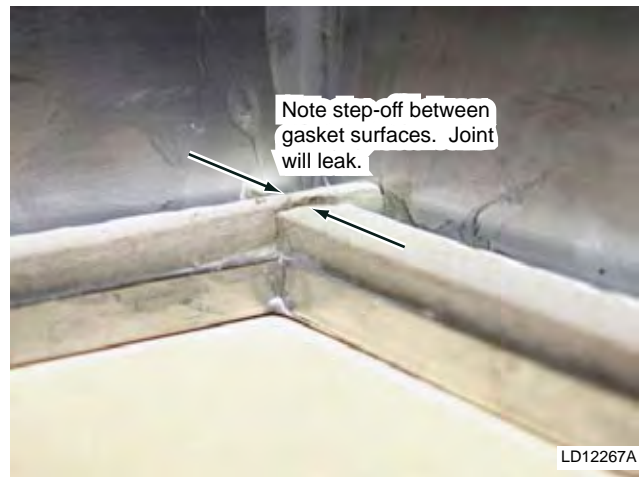


FIG. 5-64 – UNACCEPTABLE BUT JOINT, STEP-OFF BETWEEN GASKET SURFACES



FIG. 5-65 – UNACCEPTABLE BUT JOINT, VERTICAL GASKET NOT PUSHED IN FAR ENOUGH



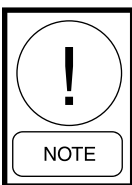
FIG. 5-66 – STEEL FRAME DOOR WITH BUT CORNER JOINT GASKET (UNITS PRODUCED AFTER OCT 2008)

INSTALL NEW GASKET ON DOOR PRODUCED AFTER OCT 2008

This procedure describes the method of installing the self-adhesive gasket in frames to eliminate air/water infiltration.

PREPARATION

1. Ensure that the frame has been cleaned and sealed.



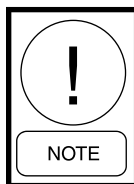
Before starting, ensure that the gasket leg has been cleaned with denatured alcohol or rubbing alcohol. Also, make sure it is dry to ensure that the gasket will adhere.



Be extremely careful when handling frames as serious cuts may occur from all exposed edges. Be extra careful when sliding fingers down the gasket to secure, as the exposed edges of the anticompression leg are extremely sharp.

2. Position the frame with the anti-compression leg up.

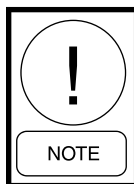
3. Measure and cut the self-adhesive gasket to fit the entire frame.



When cutting to size, cut the gasket 2" to 3" longer than needed to allow room for extra cutting and a proper fit.

GASKET INSTALLATION

1. Cut gasket and then peel red backer plastic back 12 to 18 inches (see Fig. 5-67).



Ensure that the cut is as close to 90 degrees as possible, both vertically and horizontally, to ensure a proper fit.

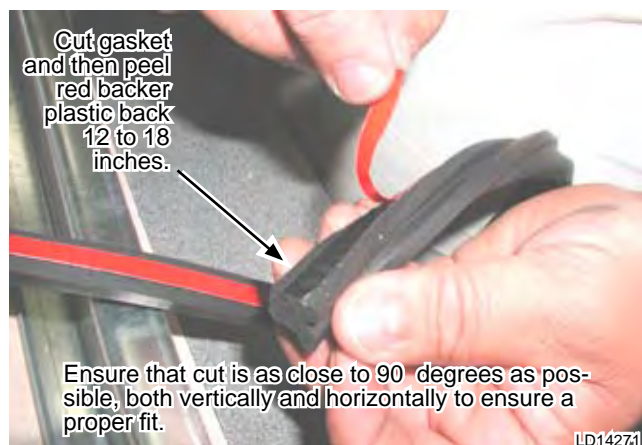
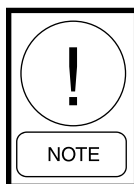


FIG. 5-67 – CUT GASKET AND PEEL BACKER

2. Starting on the latch side, 4 to 8 inches in from the horizontal, place the sticky side of the gasket down onto the gasket leg (see Fig. 5-68).



The notch on the gasket is to the outside of the frame.

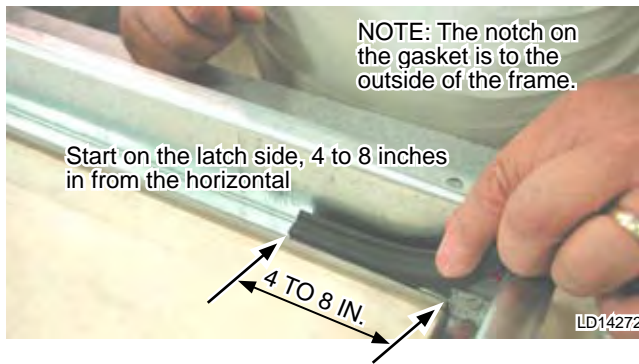


FIG. 5-68 – PLACE GASKET ON LATCH SIDE OF FRAME

3. Lay the gasket to the corner, lift the loose side of the gasket up, and begin the corner (*see Fig. 5-69*).



FIG. 5-69 – APPLY GASKET TO CORNER

4. Using the index finger, secure the corner, and wrap the unsecured side around the corner (*see Fig. 5-70*).

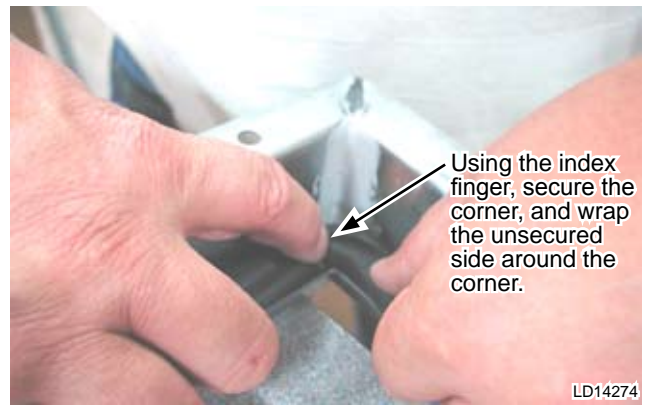
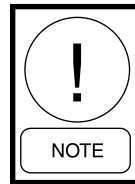


FIG. 5-70 – START CORNER

Examples of a Good Gasket Corner



Entire anticompression leg is visible and the gasket is tight with it (see Fig. 5-71).

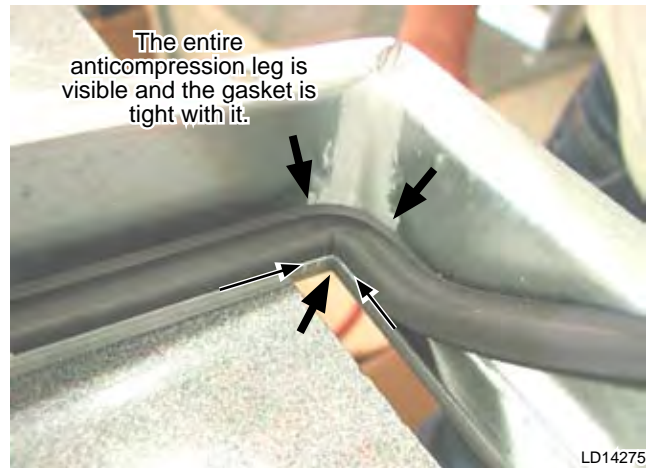
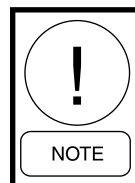


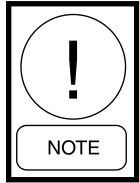
FIG. 5-71 – EXAMPLE OF A GOOD GASKET CORNER



Repeat these steps for other three corners.

Examples of Unacceptable Corners

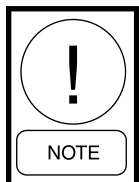
See Fig. 5-72 and 5-73 for examples of unacceptable corners.



Do not stretch the corner tight (see Fig. 5-72).



FIG. 5-72 – UNACCEPTABLE CORNER - TOO TIGHT

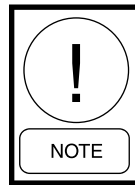


The edge of the gasket should be in contact with the corner of the anti-compression leg, +0/ -1 mm (see Fig. 5-73).



FIG. 5-73 – UNACCEPTABLE CORNER - GASKET EDGE NOT TOUCHING CORNER OF ANTICOMPRESSION LEG.

- Lay the gasket on the gasket leg next to the anti-compression leg and press into place. Gasket must be +0 / -1mm from edge of anti-compression leg (see Fig. 5-74).



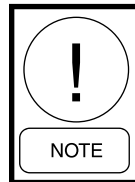
It is best not to remove more than 12 to 18 inches of the red plastic backer at once, because it will stick firmly to itself if it comes in contact.



FIG. 5-74 – LAY GASKET ON GASKET LEG

Examples of Unacceptable Gasket Fit

See Fig. 5-75 and 5-76 for examples of unacceptable gasket fit.



Gasket needs to be +0 / -1 mm from the anti-compression leg (see Fig. 5-75).

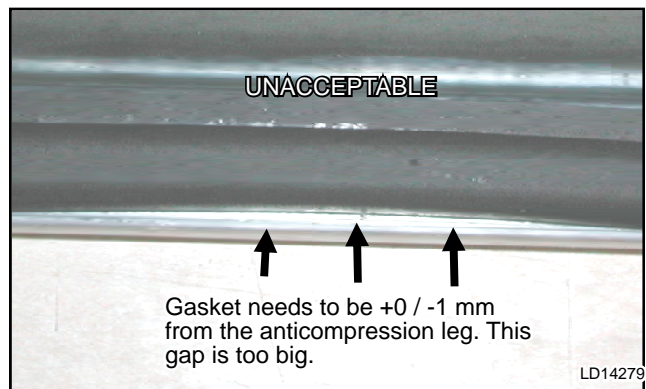
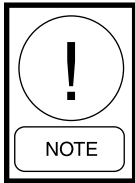


FIG. 5-75 – UNACCEPTABLE GASKET FIT - GAP TOO BIG



Gasket cannot overhang onto the anti-compression leg (see Fig. 5-76).



FIG. 5-76 – UNACCEPTABLE GASKET FIT - GASKET OVERHANGS ANTICOMPRESSION LEG.

- When you get to the starting point, overlap by 1/8" to 1/4", and make a good 90 degree cut. (It is easier to cut if the red backer plastic is still attached) (see Fig. 5-77).

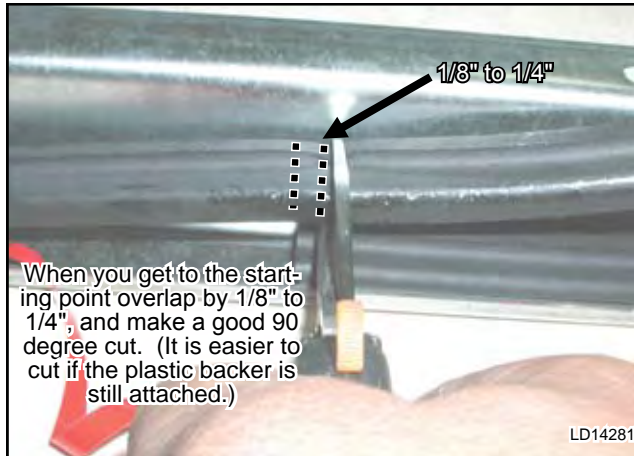


FIG. 5-77 – CUT GASKET AT STARTING POINT

- Hump the unattached gasket up slightly and move it to the secured portion (see Fig. 5-78).



FIG. 5-78 – POSITION GASKET FOR SECURING

- Push the gasket into the secured portion (see Fig. 5-79).

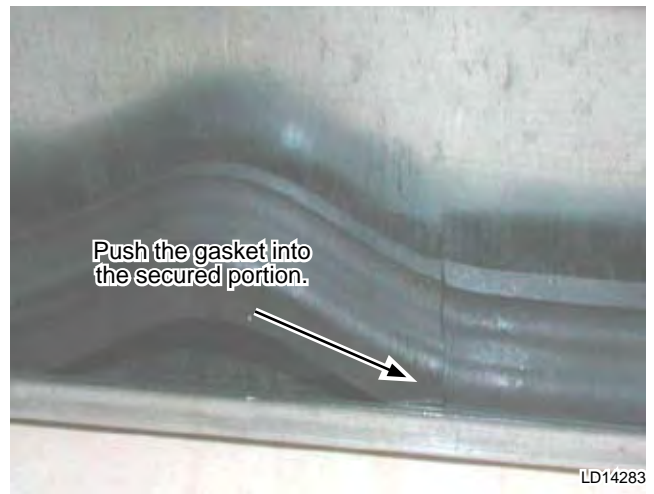
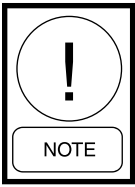


FIG. 5-79 – PUSH GASKET INTO SECURED POSITION

9. Push the gasket down onto the gasket leg (see Fig. 5-80).

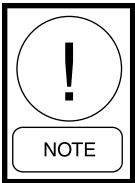


Finished joint will not have any gaps; it will be a perfect seal.



FIG. 5-80 – FINAL POSITIONING

Examples of Good Finished Joints



Joint has a perfect seal (see Fig. 5-81).

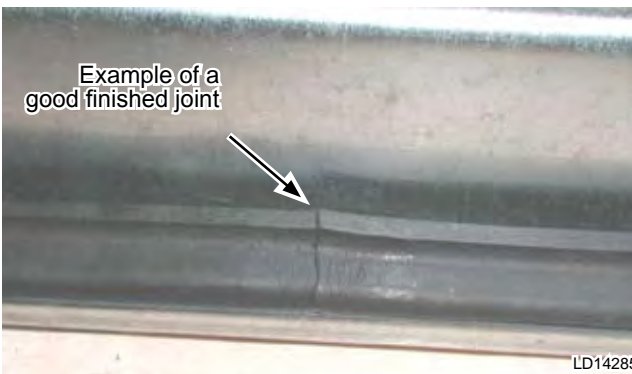


FIG. 5-81 – EXAMPLE OF A GOOD FINISHED JOINT

Examples of Unacceptable Joints

For examples of unacceptable joints see Fig 5-82 through 5-85.

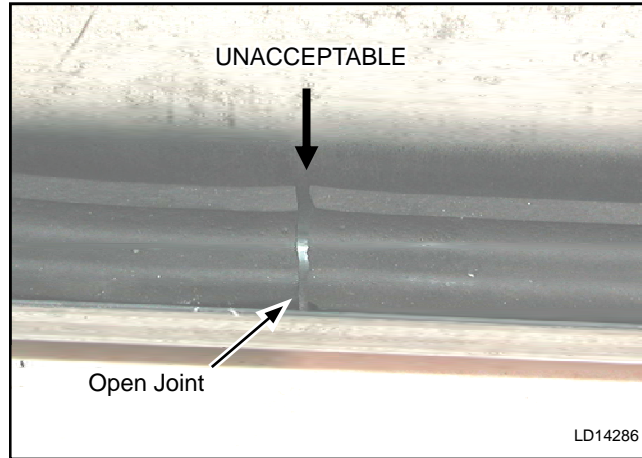


FIG. 5-82 – EXAMPLE OF AN UNACCEPTABLE JOINT - OPEN JOINT

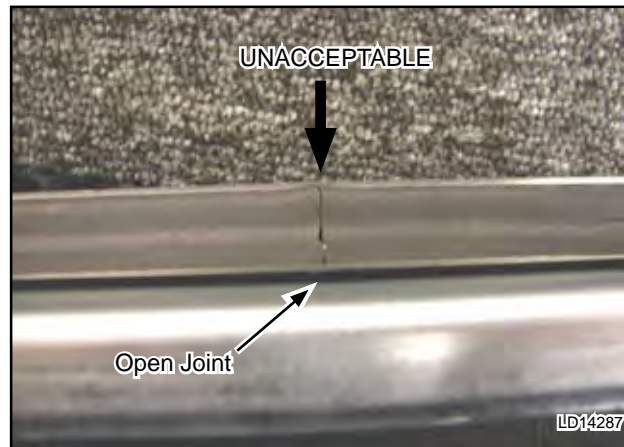


FIG. 5-83 – EXAMPLE OF AN UNACCEPTABLE JOINT - LESS OBVIOUS OPEN JOINT

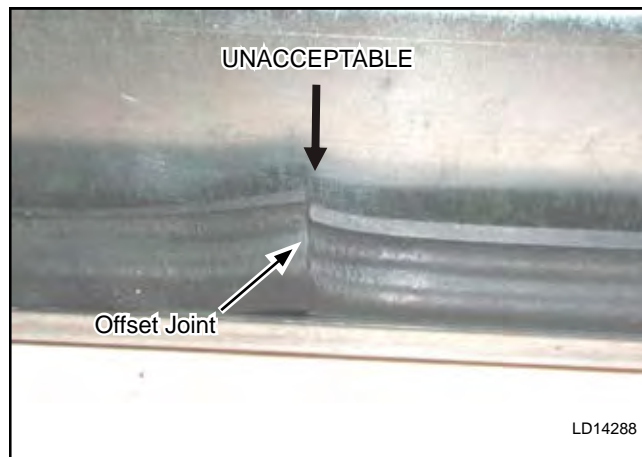


FIG. 5-84 – EXAMPLE OF AN UNACCEPTABLE JOINT - OFFSET JOINT

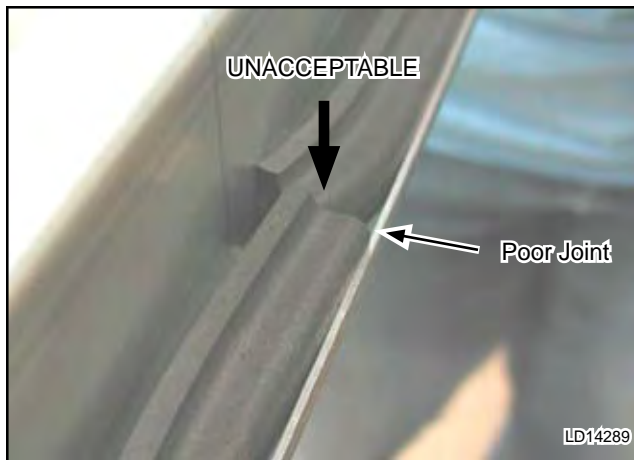


FIG. 5-85 – EXAMPLE OF AN UNACCEPTABLE JOINT - POOR JOINT

10. With fingers press entire gasket down flat onto the gasket leg, ensuring it makes a seal all the way around the frame.



FIG. 5-86 – GASKET SPLICE REQUIREMENTS

SPLICING

If the joint of the gasket is too short, and does not make a perfect seal, a splice may be used rather than replacing the entire gasket (*see Fig. 5-86*).

Requirements when splicing

- Gasket splice must be at least 12" long.
- Gasket splice can be made on the latch side only.
- Both joints where splice is made must have a perfect seal.

DOOR HANDLE/LATCH REPLACEMENT AND ADJUSTMENT

STANDARD OUT SWING DOOR

TOOLS REQUIRED

Standard mechanics tool kit.

MATERIALS REQUIRED

Correct parts for the application (*see Form 102.20-RP1*). ►

PROCEDURE

See Fig. 5-87

1. Shut down and lock out unit fan(s).
2. Remove existing door latch assembly.
3. Insert shaft of latching mechanism through hole in door from outside to inside.
4. Thread flanged retainer of latching mechanism onto mechanism shaft until firmly against inside of door.
5. Thread 3/8" flat jam nut onto mechanism shaft and tighten against retainer.
6. Install handle (without offset roller) to mechanism on outside of door using slotted screw to secure.
7. Tighten slotted screw in handle and apply plastic screw cover.
8. Add two 3/8" flat washers.
9. Add cam roller (Detail B) so that roller will engage doorframe when handle is in the downward position.
10. Add inside handle (if applicable) to mechanism shaft.
11. Thread 3/8" lock nut w/nylon washer onto mechanism shaft and tighten.
12. Repeat these steps for each individual handle on the door.
13. Check operation of door latch with unit off and with unit in operation to check for leakage.
14. If adjustment is required, add or take away 3/8" flat washers.

STANDARD OUT SWING DOOR WITH MULTI-POINT LATCH

TOOLS REQUIRED

Standard mechanics tool kit.

MATERIALS REQUIRED

Correct parts for the application (*see Form 102.20-RP1*). ►

PROCEDURE

See Fig. 5-87

1. Shut down and lock out unit fan(s).
2. Remove existing door latch assembly.
3. Insert shafts of each of the individual latching mechanisms through holes in door from outside to inside.
4. Thread flanged retainers of latching mechanisms onto each mechanism shaft until firmly against inside of door.
5. Install one handle (without offset roller) to the mechanism designated to be the "operator" on outside of door using slotted screw to secure.
6. Tighten slotted screw in handle and apply plastic screw cover.
7. To the other mechanism(s), apply push on cover(s) in place of handle(s).
8. Place the designated mechanism handle in a downward position.
9. Place the other mechanism(s) so the square shaft(s) is/are positioned the same as that of the designated mechanism shaft.
10. Apply a linkage adapter to each mechanism shaft. Be sure the peg is downward and at an angle away from the edge of the door. Also, be sure the smooth side of the linkage adapter is toward the door.
11. Install the connecting rod by engaging its holes with the respective peg on each linkage adapter.
12. Secure the connecting rod by placing an "E" ring (snap ring) in the groove on each peg.
13. Add two 3/8" flat washers.

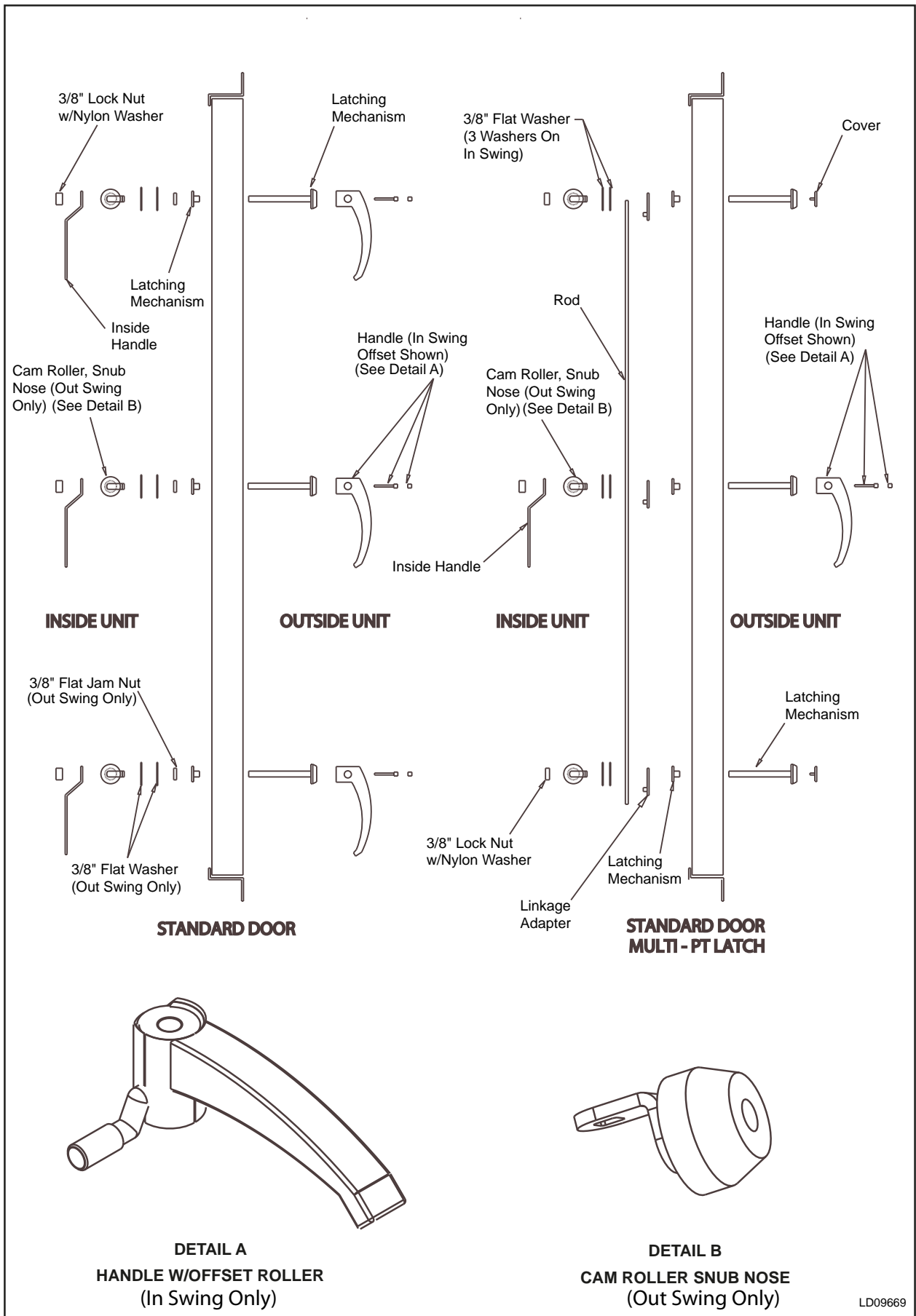


FIG. 5-87 – STANDARD DOOR LATCHES, IN SWING, OUT SWING & MULTI PT. LATCH

14. Add cam rollers (Detail B) to each mechanism shaft so that rollers will engage doorframe when handle is in the downward position.
15. Add one inside handle (if applicable) to the mechanism shaft most convenient to operate from inside unit.
16. Thread 3/8" lock nuts w/nylon washer onto each mechanism shaft and tighten.
17. Check operation of multi-point latching assembly with unit off and with unit in operation to check for leakage.

If adjustment is required, add or take away 3/8" flat washers.

STANDARD IN SWING DOOR

TOOLS REQUIRED

Standard mechanics tool kit.

MATERIALS REQUIRED

Correct parts for the application (*see Form 102.20-RP1*). ►

PROCEDURE

See Fig. 5-87

1. Shut down and lock out unit fan(s).
2. Remove existing door latch assembly.
3. Insert shaft of latching mechanism through hole in door from outside to inside.
4. Thread flanged retainer of latching mechanism onto mechanism shaft until firmly against inside of door.
5. Install handle (with offset roller - Detail A) to mechanism on outside of door using slotted screw to secure.
6. Tighten slotted screw in handle and apply plastic screw cover.
7. Add inside handle (if applicable) to mechanism shaft.
8. Thread 3/8" lock nut w/nylon washer onto mechanism shaft and tighten.
9. Ensure offset on door handle engages doorframe when handle is in the downward position.
10. Repeat these steps for each individual handle on the door.

11. Check operation of door latch with unit off and with unit in operation to check for leakage. If leakage occurs, check door gasket (*see "Door Gasket Replacement" in this section*). ►
12. If adjustment is required, add or take away 3/8" flat washers.

STANDARD IN SWING DOOR WITH MULTI-POINT LATCH

TOOLS REQUIRED

Standard mechanics tool kit.

MATERIALS REQUIRED

Correct parts for the application (*see Form 102.20-RP1*). ►

PROCEDURE

See Fig. 5-87

1. Shut down and lock out unit fan(s).
2. Remove existing door latch assembly.
3. Insert shafts of each of the individual latching mechanisms through holes in door from outside to inside.
4. Thread flanged retainers of latching mechanisms onto each mechanism shaft until firmly against inside of door.
5. Install one handle (with offset roller - Detail A) to the mechanism designated to be the "operator" on outside of door using slotted screw to secure.
6. Tighten slotted screw in handle and apply plastic screw cover.
7. To the other mechanism(s), apply push on cover(s) in place of handle(s).
8. Place the designated mechanism handle in a downward position.
9. Place the other mechanism(s) so the square shaft(s) is/are positioned the same as that of the designated mechanism shaft.
10. Apply a linkage adapter to each mechanism shaft. Be sure the peg is downward and at an angle away from the edge of the door. Also, be sure the smooth side of the linkage adapter is toward the door.

11. Install the connecting rod by engaging its holes with the respective peg on each linkage adapter.
12. Secure the connecting rod by placing an “E” ring (snap ring) in the groove on each peg.
13. Add three 3/8" flat washers.
14. Ensure offset on door handle engages door frame when handle is in the downward position.
15. Add one inside handle (if applicable) to the mechanism shaft most convenient to operate from inside unit.
16. Thread 3/8" lock nuts w/nylon washer onto each mechanism shaft and tighten.
17. Check operation of multi-point latching assembly with unit off and with unit in operation to check for leakage (see “Door Gasket Replacement” in this section). ►

ISOLATOR SPRING REPLACEMENT AND ADJUSTMENT

TOOLS REQUIRED

- Mechanics tool kit
- Pry bar (large fan base)
- Lumber blocking/cribbing (large fan base)

MATERIAL REQUIRED

- Correctly sized replacement isolator spring(s)

PROCEDURE

ISOLATOR SPRING REPLACEMENT

1. Raise fan base assembly. Block or crib as necessary.
2. Remove isolator spring(s) being replaced.
3. Place replacement spring(s) in existing rubber Isolator Cup.
4. Lower fan base assembly guiding the existing Isolator Cap over the spring(s).
5. Install washer and cap screw into top of adjustment bolt. Do not tighten cap screw at this time.

ISOLATOR ADJUSTMENT (LEVEL WITH PROPER CLEARANCES)

1. With cap screw loose, turn adjustment bolts counter clockwise to raise or clockwise to lower the fan base assembly.
2. Repeat the procedure one isolator at a time until the required distance of 5/8" is reached between the top of the isolator rail and the bottom of the spring rail.
3. Make sure the spring is not collapsed. Minimum and maximum tolerances shown in the table in Fig. 5-88 should be followed.
4. Make sure the flex connector at the fan discharge is not folded inward or pinched between the floating fan assembly and the stationery segment discharge.
5. Once the fan base assembly is adjusted, tighten the cap screws to lock the assembly in place.

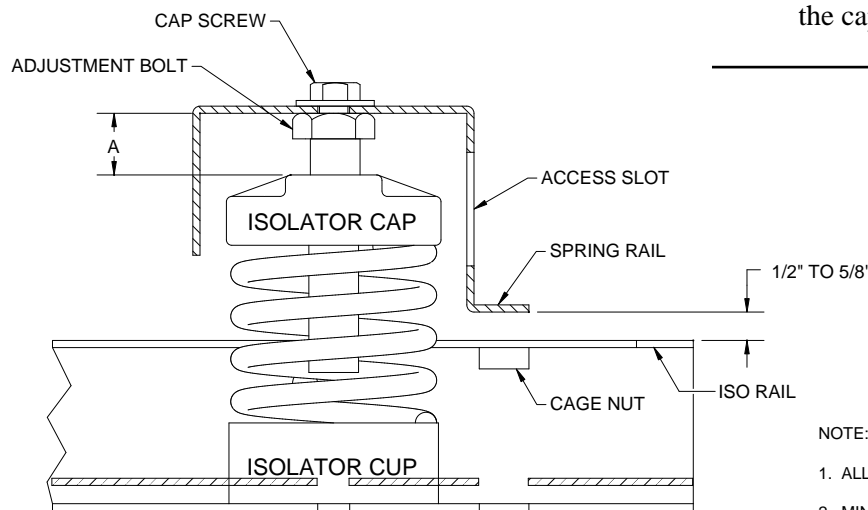


FIGURE 1

| SPRING DEFLECTION TYPE | TOLERANCE LIMIT (A) | |
|------------------------|---------------------|------|
| | MIN | MAX |
| 1.00 | 1.50 | 2.75 |
| 2.00 | 1.00 | 3.00 |

TABLE 1

NOTE:

1. ALL VALUES ARE IN INCHES.
2. MINIMUM AND MAXIMUM DISTANCE ARE MEASURED FROM THE TOP OF THE ADJUSTING BOLT, AS SHOWN IN FIGURE 1.

LD12559

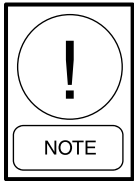
FIG. 5-88 – ISOLATOR MOUNTING

THRUST RESTRAINT REPLACEMENT AND ADJUSTMENT

Fan segments are cabinets containing a fan and motor. They can develop extremely high thrusts. These forces are horizontally opposite to the airflow. Thrust restraints are provided for all fans when the air thrust exceeds 15% of the equipment weight when the fan discharge is rear (see Fig. 5-89). Any other fan orientation does not require restraints due to one of several reasons:

- **Top and Top Inverted** - Isolators function as thrust restraints.
- **Bottom and Bottom Inverted** - The weight of the fan/motor exceed potential thrust.
- **Rear Inverted** - The horizontal thrust component is low with respect to the center of gravity of the fan/motor assembly.

REAR DISCHARGE ORIENTATION



- *On forward curved fans, the thrust is under 15% of the total weight. Hence, the thrust restraints are not required.*
- *On airfoil fans, it is required that thrust restraints be used where the TSP is greater than 6"*
- *On plenum fans, it is required that thrust restraints be used where the TSP is greater than 3".*

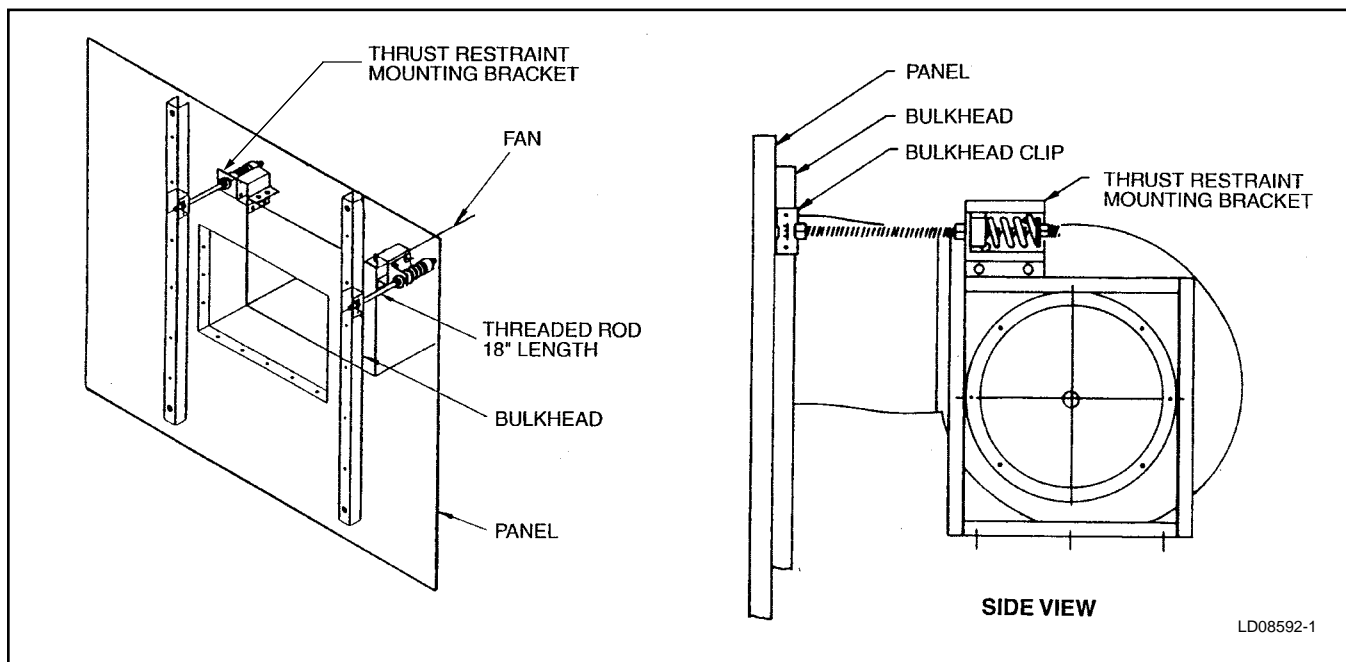


FIG. 5-89 – SUPPLY FAN RESTRAINT

TOOLS REQUIRED

Two 8" crescent wrenches.

MATERIAL REQUIRED

Appropriate Thrust Restraint Kit (see Form 102.20-RP1). ►

PROCEDURE

See Fig's 5-89 & 5-90

THRUST RESTRAINT REPLACEMENT

Supply fan is attached to bulkhead (or bulkhead clip), one thrust restraint on each side near top of fan.

1. Remove any existing thrust restraints.
2. If fan wall will not support thrust or brackets, install additional support from floor to roof and tie in at top, bottom and about 4' intervals.
3. If fan structure angle is not present or doesn't line up, adjust thrust restraint mounting brackets (or clips) furnished with thrust restraints. Attach to each side of fan housing nearest top and toward discharge.
4. Lock two nuts together on one end of threaded rod.
5. Finally, add first flat steel washer, first flat rubber washer, first steel cup retainer, spring, second steel cup retainer, second flat rubber washer and second flat steel washer.

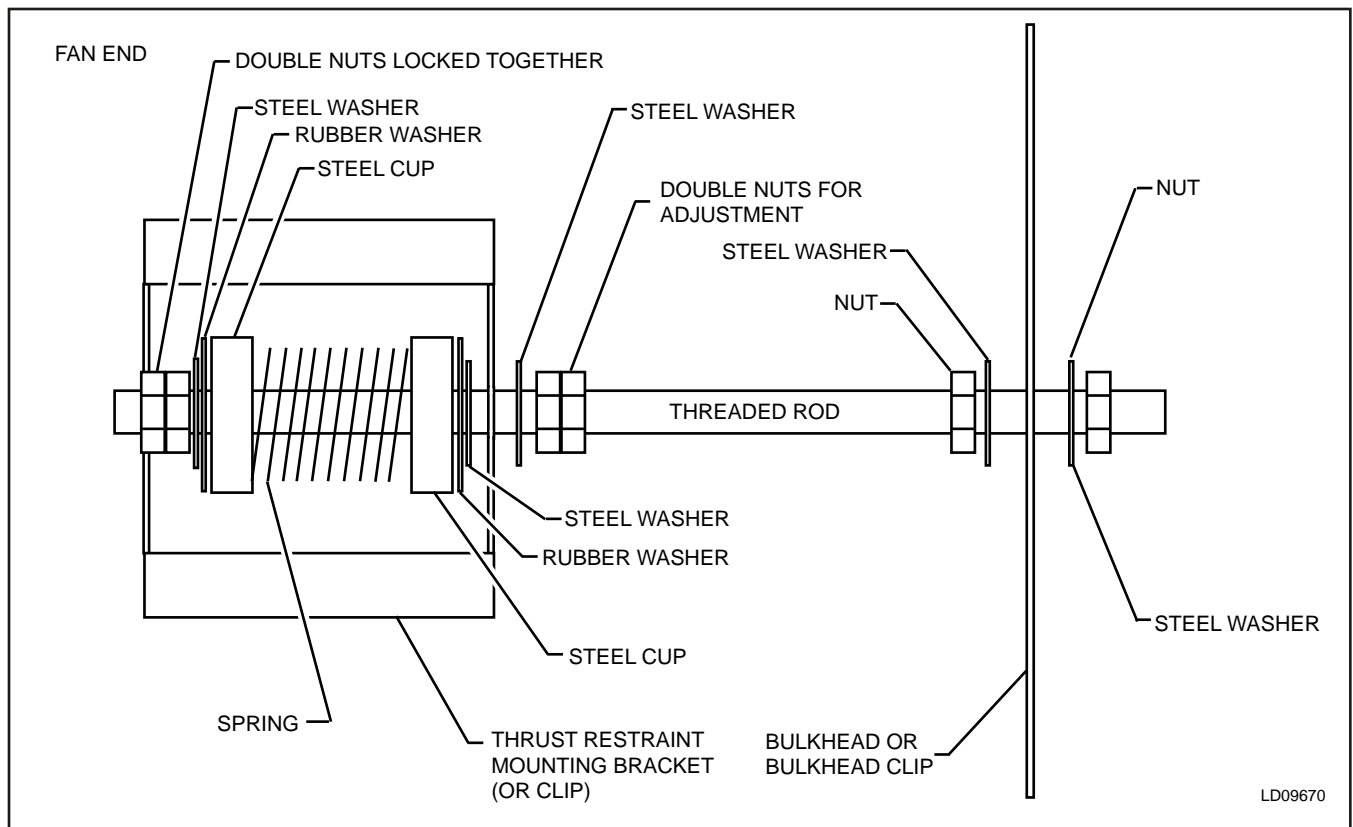
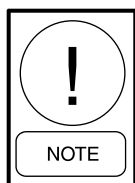


FIG. 5-90 – THRUST RESTRAINT ASSEMBLY

6. Slide threaded rod through thrust restraint mounting bracket on fan (or clip) toward bulkhead (or bulkhead clip).
7. Add third flat steel washer and two nuts that will lock together in a later step.
10. Push threaded rod through bulkhead (or bulkhead clip) until spring parts are against thrust restraint mounting bracket on fan (or clip).
11. Tighten nuts on both sides of bulkhead (or bulkhead clip).



The hardware thus far goes to the fan end of threaded rod.

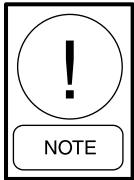
8. Next add one nut and flat one steel washer and slide threaded rod through bulkhead (or bulkhead clip).
9. Add flat steel washer and one nut on the other side of bulkhead (or bulkhead clip).

THRUST RESTRAINT ADJUSTMENT

After installing thrust restraint, adjust as follows:

1. Ensure nuts are tight on both sides of bulkhead or bulkhead clip.
2. Adjust third flat steel washer and second set of double nuts hand tight against thrust restraint mounting bracket on fan.
3. Turn second set of double nuts four full turns toward spring and lock in place.
4. Repeat this process for each thrust restraint.

**FIELD CUT OPENINGS FOR DUCTS,
DAMPERS AND SPECIAL ACCESS FOR
YORK SOLUTION DOUBLE WALL 2"
PANELS**



A pre-manufactured replacement panel with your specified opening size and location may be available through Baltimore Parts Center—Airside or Local Johnson Controls Service.



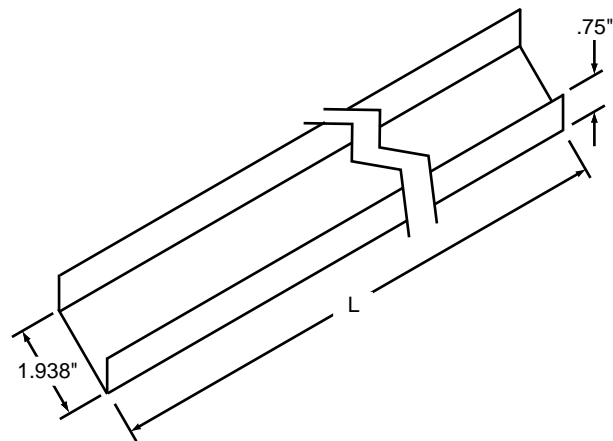
If your unit has HEPA filters the filter frames, filter bulkheads and filter segment panels are factory sealed and must remain sealed for NO air bypass.

TOOLS REQUIRED

- Screw gun with #3 Phillips bit.
- Gasket scraper.
- Broad, thin pry bar.
- Drill motor.
- One-eighth inch drills.
- Pop rivet gun.
- Hole saw-approximately 1-1/2" diameter for starter holes.
- Power saw or power shear for metal cutting.
- Power cords as required.
- Awl.

MATERIAL REQUIRED

- Two prefabricated pieces of “C” channel used for stiffeners and insulation covers equal to the height of the new opening. If this were a side panel, this would be “vertical”. This channel is 20 gauge galvanized sheet metal, 1.938" wide with .750" legs. Available through Baltimore Parts Center-Airside (see Fig. 5-91).
- Two prefabricated pieces of “C” channel used for stiffeners and insulation covers equal to the width of the new opening. If this were a side panel, this would be “horizontal”. This channel is 20 gauge galvanized sheet metal, 1.938" wide with .750" legs, available through Baltimore Parts Center-Airside (see Fig. 5-91).



Notes:

1. Select the C-Channel that is nearest to the size of your opening and cut to fit.
2. Available lengths (L) for stiffeners:

| PART NUMBER | LENGTH (L) |
|---------------|------------|
| 087-40048-050 | 47.938" |
| 087-40072-050 | 71.938" |
| 087-40127-050 | 126.938" |

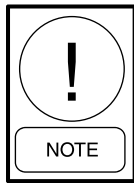
LD09671

FIG. 5-91 – C-CHANNEL

- 1/8" steel pop rivets for 1/4" working thickness.
- Paint, cold galvanized.
- Paint, touchup spray, champagne, P/N 013-03322-000 (for outdoor unit exterior only).
- Caulk, P/N 013-02966-011 gray for indoor units or 013-03317-040 for outdoor units with champagne paint.
- For door and panel flanges, use gasket, neoprene .75"w x .25" thk, P/N 028-11873-010.
- Panel screws 1/4" x 3/4" pan head thread forming sheet metal screw, P/N 021-17722-000.
- Clean up supplies.

PROCEDURE

1. Cut the “C” Channel stiffeners to fit opening. Use for stiffening the cut panel and for sealing of insulation and probable air leakage areas.
2. Make sure any components; bulkheads or other obstructions are disconnected from panel inside and out.
3. When removing panel, to prevent damage of outdoor unit remove panel slowly allowing butyl tape to release.



Panels can often be cut in place without removing from the air handling unit.

4. Layout location and dimensions of opening to be cut. Do this on both sides of double wall panels.
5. Cut desired opening in panel insuring cuts on both sides line up.
6. Insert stiffeners, legs first, by tapping into panel until flush with new panel opening. This simultaneously forces the legs of the “C” channels between the foam insulation and the liner and between the foam insulation and the outer sheet metal without damage to the insulation. Be sure the broad sides of the “C” channels line up to form the desired opening dimensions. This should be flush with edges of the new opening.
7. Secure “C” channels with pop rivets at 3" intervals on a line ¼" from the new opening edges. When fastening with pop rivets avoid buckling or bulging of sheet metal by applying rivets simultaneously on each side of opening, working from center to corners.
8. Apply gray sealant to corner seams and all seams inside the new opening.
9. Paint rivets and raw edges of sheet metal with cold galvanized paint.
10. If the panel was removed, clean away damaged or residual gasket or sealing compound and replace with appropriate material (*see material list above*).
11. Install panel on air handling unit carefully using panel screws (*see material list above*).
12. All re-installed panels and alterations of panels must provide integrity equal to original equipment specifications.
13. Reconnect any components, bulkheads or other fixtures that were disconnected from panel in step # 2.
14. Thoroughly clean up inside and outside air unit.

PANEL REPLACEMENT



If your unit has HEPA filters the filter frames, filter bulkheads and filter segment panels are factory sealed and must remain sealed for NO air bypass.

TOOLS REQUIRED

- Screw gun with #3 Phillips bit.
- Gasket scraper.
- Broad, thin pry bar.
- Awl.

MATERIAL REQUIRED

- Replacement panel, available through Airside Parts.
- Caulk, P/N 013-02966-011 gray for indoor units or 013-03317-040 for outdoor units with champagne paint.
- For door and panel flanges, use gasket, neoprene .75"w x .25" thk, P/N 028-11873-010.
- Panel screws ¼" x ¾" pan head thread forming sheet metal screw, P/N 021-17722-000.
- Paint, touch-up spray, champagne, P/N 013-03322-000.
- Clean up supplies.

PROCEDURE

1. Make sure any components; bulkheads or other obstructions are disconnected from panel inside and out (*see Fig. 5-92*).

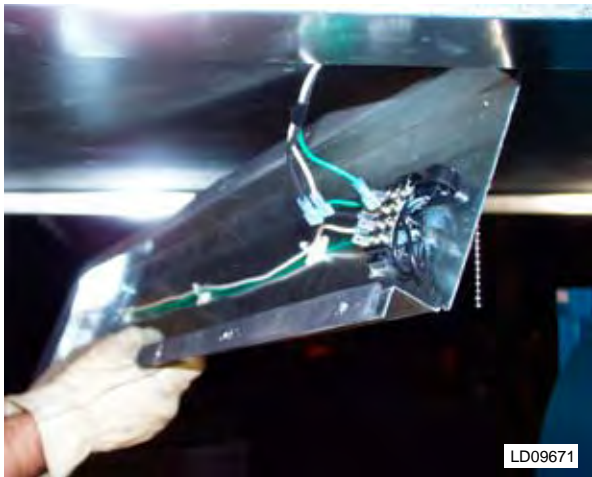


FIG. 5-92 – REMOVE COMPONENTS PRIOR TO REMOVING PANELS.

2. When removing panel, to prevent damage of outdoor unit remove panel slowly allowing butyl tape to release.

Prior to panel removal on tiered or vertical units, cut any gasket that crosses a seam. This will prevent tearing gaskets.

3. Clean away damaged or residual gasket or sealing compound and replace with appropriate new material (*see material list above*).
4. Install panel on air handling unit carefully using panel screws (*see Fig. 5-93*).

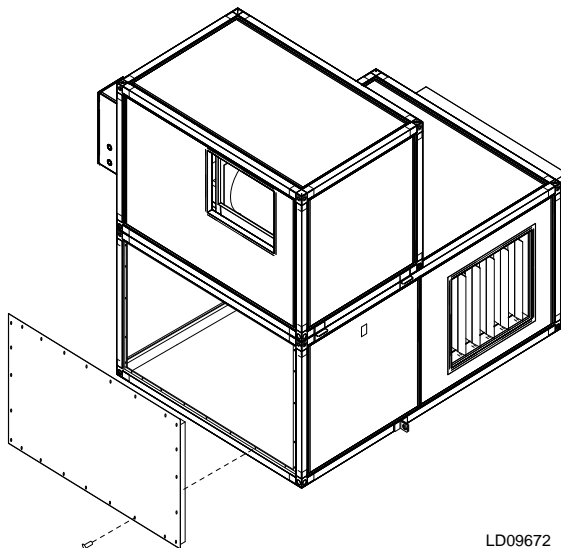


FIG. 5-93 – INSTALL PANELS

5. All re-installed panels must provide integrity equal to original equipment specifications.
6. Seal all penetrations with caulk.
7. Reconnect any components, bulkheads or other fixtures that were disconnected from panel in step # 1.
8. Thoroughly clean up inside and outside air unit.

PRESSURE TAPE REMOVAL AND INSTALLATION INSTRUCTIONS ON XTO ROOF PANELS

This information details the proper procedure for field repair of factory roof seams on XTO air handlers using new style seam sealing strip. Be sure to use applicable safety equipment when performing these procedures.



Gloves should be used when handling stainless steel tape; edges are very sharp and could cause injury.

TOOLS REQUIRED

- Caulk gun.
- Spray bottle.
- Gloves.
- Clean rags.
- Tape measure or ruler.
- Steel roofers roller or wallpaper roller.

MATERIAL REQUIRED

- MicroSealant seam strips, P/N 028-11888-010, champagne, 4" w x 50 ft. roll.
- Caulk, Manus-Bond 75-AM, P/N 013-02966-011.
- Paint, champagne, 12oz spray can, P/N 013-03322-000.
- Isopropyl alcohol.

SEAM SEALING STRIP ORDERING INFORMATION

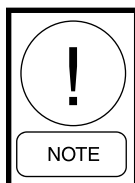
The new style seam sealing strip can be purchased through Airside Parts in Johnstown, PA (800-545-7814) or Baltimore Parts Center. The seam strips ship in 4 inch x 50 foot rolls. To determine the amount needed use the following equation:

$$\frac{(\text{unit width} + 12 \text{ inches}) \times \# \text{ of factory seams}}{12} = \text{feet of sealing strip needed}$$

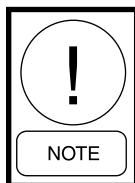
The +12 inches are to cover the drip edge on each side and wrapping the tape under it as shown in Figs. 5-94 and 5-95. Since all dimensions are in inches, the 12 indicated in the equation converts inches to feet.

PROCEDURE

1. Score paint with utility knife along stainless steel strip edge to reduce paint chipping and flaking.
2. Remove existing stainless steel seam sealing strip from seam.
3. Clean seam area by spraying the isopropyl alcohol and wiping thoroughly with a clean rag. It is not necessary to remove old glue left by removal of the stainless steel sealing strip.
4. Inspect the existing caulk. If gaps are present or the existing caulk is not applied over the black gasket along the raceway, apply additional caulk. Be sure to apply any additional caulking so the new material lays flat along the seam.



Do not use silicone based caulk. Only use urethane based factory approved caulk listed above.



When applying the new seam sealing strip, DO NOT stretch the material across the seam. Doing so may cause application issues.

5. When surface is dry, apply the sealing strip along the seam as shown in Figs. 5-94 through 5-96, making sure not to stretch the material. The sealing strip should hang over the drip edge and be wrapped back up under as shown.



FIG. 5-94 – APPLY CENTERED OVER SEAM



FIG. 5-95 – UNDER DRIP AND OVERHANG



FIG. 5-96 – DO NOT STRETCH

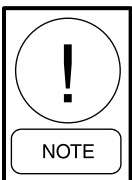
6. Apply pressure to the sealing strip by using a clean rag in a back and forth motion along the seam (Fig. 5-97). Pressure activates the adhesive, so be sure to apply pressure along the entire seam. A small hand roller is recommended.



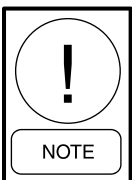
FIG. 5-97 – APPLY PRESSURE - ROLLER RECOMMENDED

7. Once seams are repaired, check ALL of the roof screws and replace them if they are stripped out. Apply caulking in the screw hole and install a 1" X 17 screw, with rubber washer. (Fastenal # 31917).

FIELD PENETRATIONS FOR PIPING & ELECTRICAL CONNECTIONS



For small sizes such as 1/2" iron pipe, 1/2" conduit or 5/8" O.D. copper and smaller; it is acceptable to use caulk instead of a grommet.



Electrical conduits must be sealed internally to prevent airflow and moisture condensation.

TOOLS REQUIRED

- Drill motor.
- Pilot starter bit.
- Hole saws-approximately 2-1/2", 3-1/4" & 4-1/2" diameter for holes.
- Power cords as required.

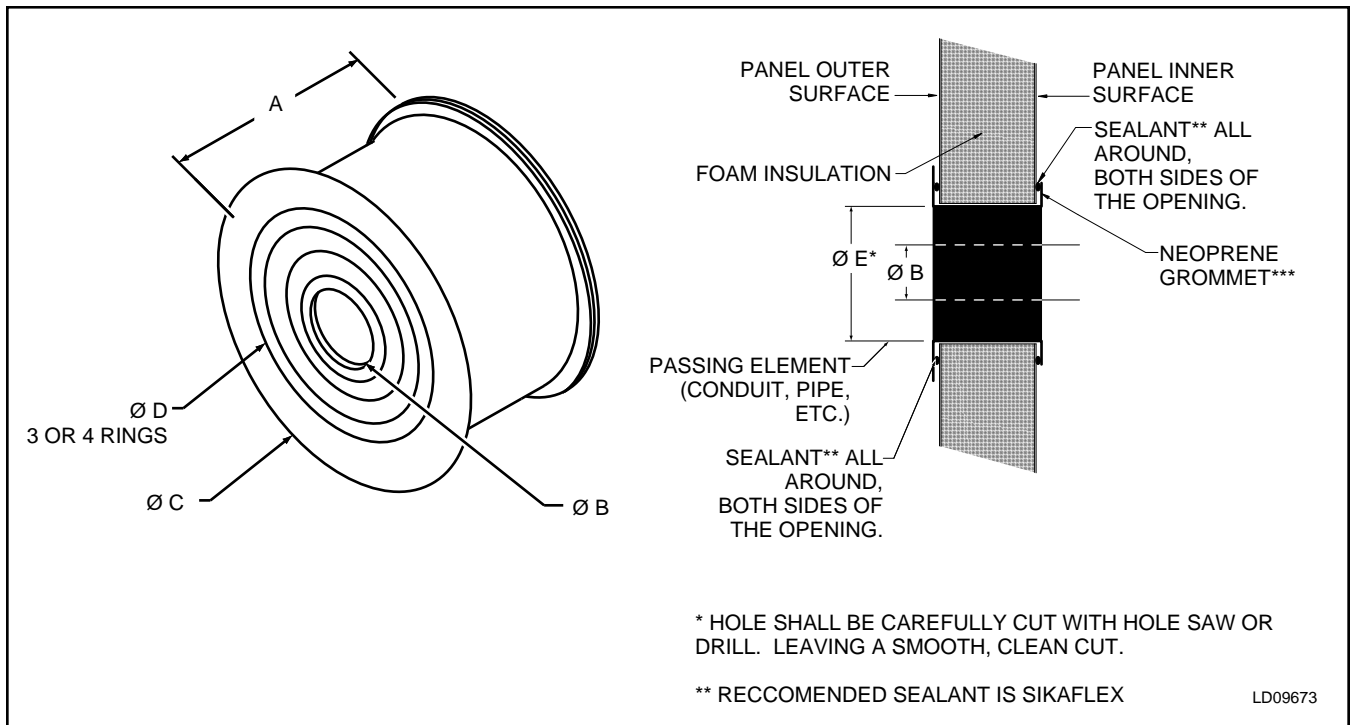
MATERIAL REQUIRED

- Neoprene grommet, 2-1/2", 3-1/4", 4-1/2" or 5-1/2" as required (*see Fig. 5-98*).
- Cold galvanized paint.
- Paint, touchup spray, champagne, P/N 013-03322-000 (for outdoor unit exterior only).
- Caulk, P/N 013-02966-011 gray for indoor units or 013-03317-040 for outdoor units with champagne paint.
- Exacto knife.
- Clean up supplies.

PROCEDURE

See Fig. 5-98

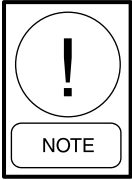
1. Make sure any components; bulkheads or other obstructions are disconnected from panel inside and out.
2. Layout location and dimensions of hole opening to be cut. Do this on both sides of double wall panels.
3. Carefully cut correct hole size for the application in panel, insuring cuts on both sides line up and a smooth clean cut is made.
4. Paint raw edges of sheet metal with cold galvanized paint.
5. Select appropriate grommet for new panel hole and cut out appropriate hole diameter for penetration with an Exacto knife.
6. After paint dries, Install grommet into panel hole opening.
7. Apply sealant all around new hole opening behind lip of grommet, on both sides of panel.
8. Run pipe or conduit through grommet and make appropriate connections.
9. All modified panels must provide integrity equal to original equipment specifications.
10. Reconnect any components, bulkheads or other fixtures that were disconnected from panel in step # 1.
11. Thoroughly clean up inside and outside air unit.



| | | | | DIMENSIONS | | | | |
|--------------------------|-------------------------|-------------------|-----------------|-------------------|----------------------------|---------------------------|---|------------------------------|
| IRON PIPE SIZE (nominal) | COPPER PIPE SIZE (O.D.) | THIN WALL CONDUIT | USE GROMMET P/N | GROMMET DEPTH (A) | GROMMET HOLE DIAMETER (ØB) | GROMMET LIP DIAMETER (ØC) | MARKED GROMMET HOLE DIAMETER (CUT OUT) (ØD) | PANEL HOLE CUT DIAMETER (ØE) |
| 3/4", 1" | 7/8", 1-1/8" | 3/4", 1" | 028-11872-000 | 2.375" | 0.500" | 3.125" | 0.749 | 2.50" |
| 1-1/4", 1-1/2" | 1-3/8", 1-5/8" | 1'1/4", 1-1/2" | 028-11871-000 | 2.375" | 1.000" | 3.875" | 1.249 | 3.25" |
| 1-1/4", 1-1/2" | 1-3/8", 1-5/8" | 1'1/4", 1-1/2" | 028-11872-000 | 2.375" | 0.500" | 3.125" | 1.249 | 2.50" |
| 1-1/4", 1-1/2" | 1-3/8", 1-5/8" | 1'1/4", 1-1/2" | 028-11861-000 | 2.375" | 1.000" | 5.125" | 1.251 | 4.50" |
| 2" | 2-1/8" | 2" | 028-11871-000 | 2.375" | 1.000" | 3.875" | 1.749 | 3.25" |
| 2" | 2-1/8" | 2" | 028-11861-000 | 2.375" | 1.000" | 5.125" | 1.751 | 4.50" |
| 2" | 2-1/8" | 2" | 028-11872-000 | 2.375" | 0.500" | 3.125" | 1.875 | 2.50" |
| 2-1/2" | 2-5/8" | 2-1/2" | 028-11861-000 | 2.375" | 1.000" | 5.125" | 2.251 | 4.50" |
| 2-1/2" | 2-5/8" | 2-1/2" | 028-11871-000 | 2.375" | 1.000" | 3.875" | 2.375 | 3.25" |
| 3" | 3-1/8" | 3" | 028-11861-000 | 2.375" | 1.000" | 5.125" | 2.875 | 4.50" |
| 4" | 4-1/8" | 4" | 028-11881-000 | 2.251" | 1.250" | 6.125" | 3.875" | 5.50" |

FIG. 5-98 – PENETRATIONS AND GROMMET DETAILS

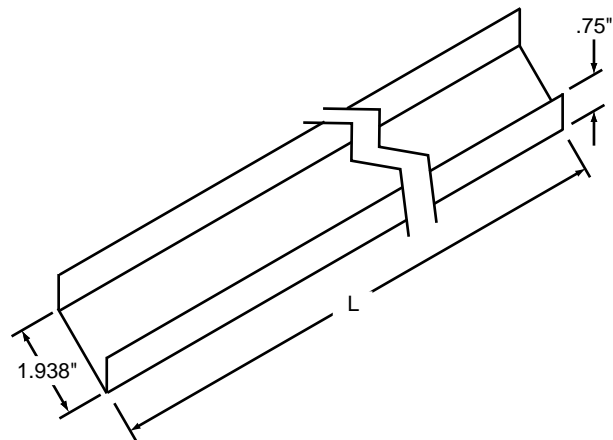
FIELD MODIFICATION TO ADD DOORS



This procedure instructs how to modify panels in order to install a door that runs from the top to bottom raceway. For doors that are smaller than the height of the air handler see “Field Cut Openings for Ducts, Dampers and Special Access for YORK Solution Double Wall 2” Panels” ► and “Door Replacement” ► procedures found in this IOM.



If your unit has HEPA filters the filter frames, filter bulkheads and filter segment panels are factory sealed and must remain sealed for NO air bypass.



- Notes:
1. Select the C-Channel that is nearest to the size of your opening and cut to fit.
 2. Available lengths (L) for stiffeners:

| PART NUMBER | LENGTH (L) |
|---------------|------------|
| 087-40048-050 | 47.938" |
| 087-40072-050 | 71.938" |
| 087-40127-050 | 126.938" |

LD09671

TOOLS REQUIRED

- Standard mechanic’s hand tools.
- Spacers, 1/8" thick approximately.
- Screw gun with #3 Phillips bit.
- Awl.
- Gasket scraper.
- Broad, thin pry bar.
- Drill motor.
- One-eighth inch drills.
- Pop rivet gun.
- Hole saw-approximately 1-1/2" diameter for starter holes.
- Power saw or power shear for metal cutting.
- Power cords as required.

MATERIAL REQUIRED

- For door and panel flanges, use gasket, neoprene .75"w x .25" thk, P/N 028-11873-010.
- Two prefabricated pieces of “C” channel (one piece if door is to be mounted at a corner) used for stiffeners and insulation covers equal to the height of the panel. This channel is 20 gauge galvanized sheet metal, 1.938" wide with .750" legs. Available through Baltimore Parts Center-Airside (see Fig. 5-99).

FIG. 5-99 – C-CHANNEL

- Steel pop rivets, 1/8", for ¼" working thickness.
- Self-drilling screws, 1/4"-14 x 3/4", P/N 021-19515-000.
- Paint, cold galvanized.
- Paint, touchup spray, champagne, P/N 013-03322-000 (for outdoor unit exterior only).
- Caulk, P/N 013-02966-011 gray for indoor units or 013-03317-040 for outdoor units with champagne paint.
- Panel screws ¼" x ¾" pan head thread forming sheet metal screw, P/N 021-17722-000.
- Clean up supplies.

PROCEDURE

1. Make sure any components; bulkheads or other obstructions are disconnected from panel inside and out.
2. When removing panel, to prevent damage of outdoor unit remove panel slowly allowing butyl tape to release.

3. Clean away damaged or residual gasket or sealing compound and replace with appropriate new material (*see material list above*).
4. Cut “C” Channel stiffener(s) to fit. Use to strengthen the cut panel(s) and for sealing of insulation and probable air leakage areas.
5. Layout location of door for cutting. Do this on both sides of double wall panel.
6. Cut panel from top to bottom at desired location ensuring cuts on both sides line up.
7. Insert stiffeners, legs first, by tapping into panel until flush with cut edges of panel. This simultaneously forces the legs of the “C” channels between the foam insulation and the liner and between the foam insulation and the outer sheet metal without damage to the insulation.
8. Secure “C” channels with pop rivets at 3" intervals on a line ¼" from the edge of the cut panel(s). When fastening with pop rivets avoid buckling or bulging of sheet metal by applying rivets simultaneously on each side of cut panel(s), working from center to top and bottom.
9. Apply gray sealant to seal the “C” channel to cut edges.
10. Paint rivets and raw edges of sheet metal with cold galvanized paint.
11. Install panel(s) on air handling unit carefully using panel screws (*see Fig. 5-100*).

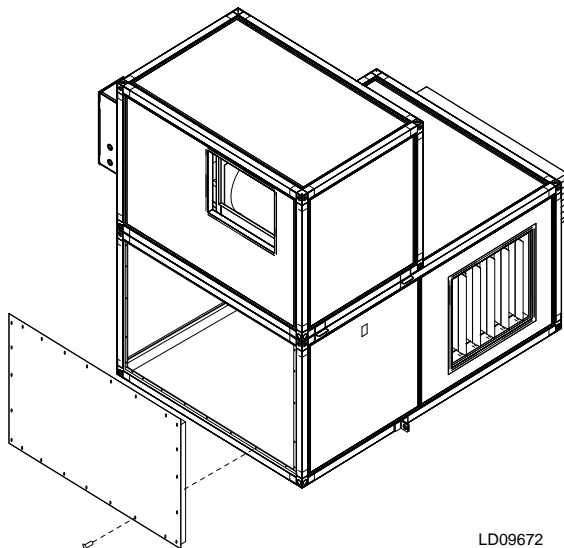
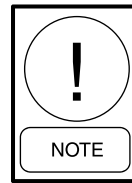
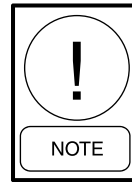


FIG. 5-100 – INSTALL PANELS



All re-installed panels and alterations of panels must provide integrity equal to original equipment specifications.

12. Reconnect any components, bulkheads or other fixtures that were disconnected from panel in step # 1.
13. Apply gasket material to back of doorframe along the outer edge. Use compound sealing (butyl tape), P/N 013-02976-000 for outdoor unit and neoprene gasket, P/N 028-11873-010 for indoor unit.



New door assemblies are provided with plastic spacers to maintain proper alignment.

14. Install new door assembly with door closed and latched with spacers in place (*see Fig. 5-101*).

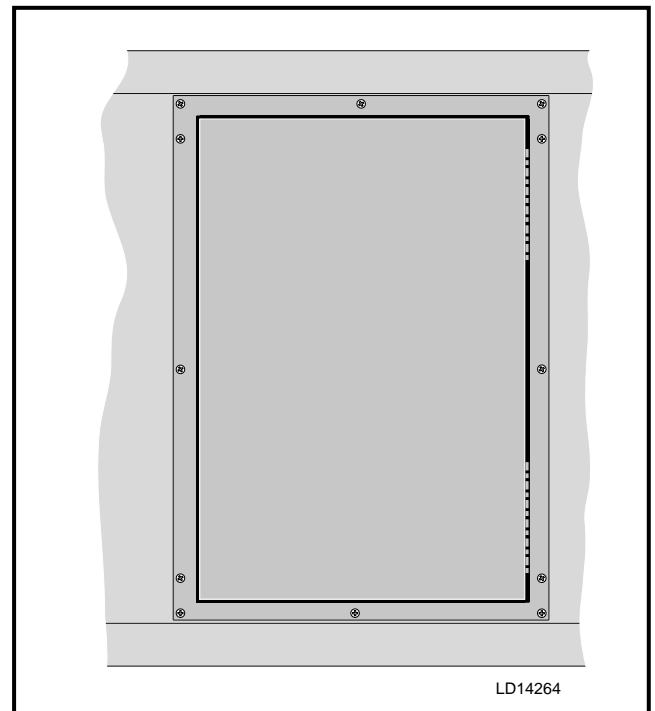


FIG. 5-101 – DOOR REPLACEMENT

15. Then, install self-drilling screws in hinge side of doorframe.
16. Finally, install self-drilling screws in top, bottom and latch sides of doorframe.

17. Check operation of door with unit off.
18. Check for obvious air leakage with air unit in operation
19. Thoroughly clean up inside and outside air unit.
20. Touch up paint as needed.

LIGHT BULB REPLACEMENT

TOOLS REQUIRED

- Phillips screwdriver, #2.

MATERIALS REQUIRED

- Lamp, Incandescent, 75W or Fluorescent, 20W.

PROCEDURE

See Fig. 5-102

1. Disconnect power from light assembly.
2. Remove two #2 Phillips screws connecting cover to base.
3. Remove cover and replace bulb.
4. Fasten cover to base with two #2 Phillips screws.

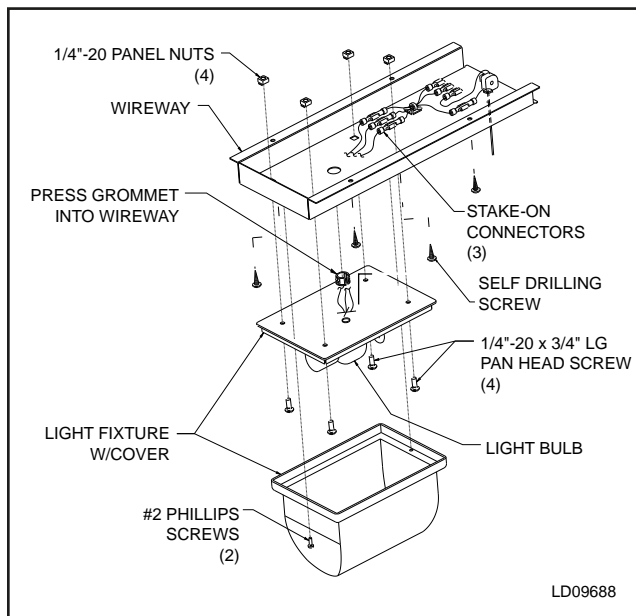


FIG. 5-102 – LIGHT ASSEMBLY PULL SWITCH (SHOWN)

LIGHT ASSEMBLY REPLACEMENT

TOOLS REQUIRED

- Phillips screwdriver, # 2.
- Nut setter or socket, 1/4".

MATERIALS REQUIRED

- Light Fixture w/ Cover (P/N 025-39013-001).

PROCEDURE

See Fig. 5-102

1. Disconnect power from light assembly.
2. Remove wireway from where it fastens to top panel by removing all self drilling screws.
3. Disconnect “stake-on” electrical connectors (see Fig. 5-103).

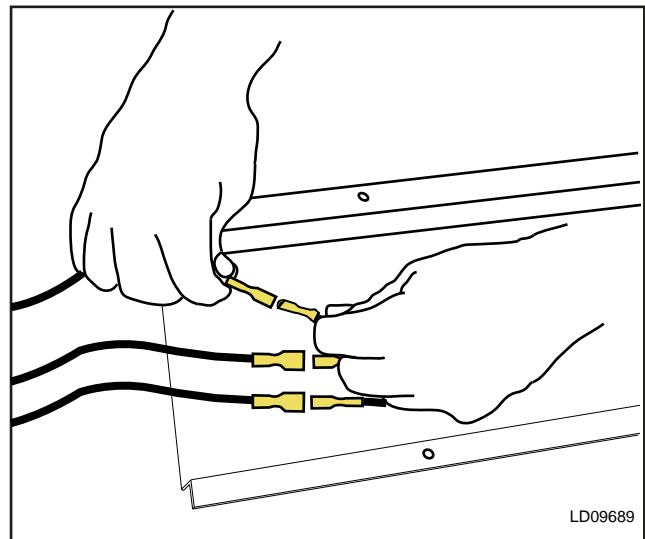


FIG. 5-103 – REMOVE ELECTRICAL CONNECTORS

4. Remove two #2 Phillips screws connecting cover to base.
5. Separate light assembly from wireway by removing four 1/4"-20 x 3/4" long pan head screws.
6. Remove grommet from wireway and light assembly; save for reuse.
7. Install new light assembly by reversing steps 1 through 6.



LD11693

FIG. 5-104 – MINIHELIC GAGE

FILTER GAGE REPLACEMENT

TOOLS REQUIRED

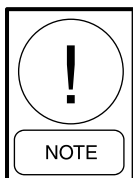
- Four inch adjustable wrench or ignition wrench set.
- Long, thin straight slot screwdriver.
- Caulking gun.

MATERIALS REQUIRED

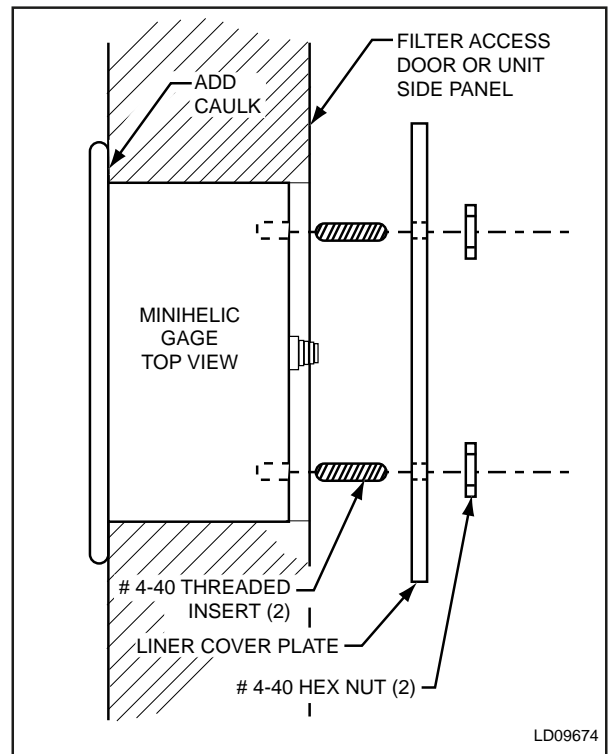
- Caulk, P/N 013-03317-050 aluminum gray or 013-03317-040 for outdoor units with champagne paint.

PROCEDURE

1. Remove the 3/16" tubing from barbed fittings on the back of the gage. Identify each tube as "HIGH" or "LOW".
2. Remove two #4-40 hex nuts and remove the liner cover plate that holds the filter gage in place.
3. Cut existing caulking from perimeter of gage.
4. Slide gage through front of filter access door or unit side panel.
5. Clean old caulking from access panel.



The replacement filter gage will be mounted to the liner cover plate by two (2) #4-40 threaded inserts and hex nuts that come with the gage.



LD09674

FIG. 5-105 – ASSEMBLY OF GAGE TO LINER COVER PLATE

6. Insert two #4-40 threaded inserts into the threaded holes located in the rear of the replacement gage (see Fig. 5-105).
7. Run a small bead of sealant around the exterior perimeter of the gage where it will seal against the filter access door or unit side panel.
8. Slide gage into opening on access panel.
9. Slide liner cover plate over two #4-40 threaded inserts.
10. Secure gage by tightening two #4-40 hex nuts, making sure gage face is level.
11. Re-connect 3/16" tubing to barbed fittings on the back of the gage.
12. Remove lens by pressing finger tips firmly against lens outer ring and turning CCW.
13. Without any air applied, turn adjustment screw until gage reads zero.
14. Replace lens.

FILTER GAGE INSTALLATION (FIELD CUT)**TOOLS REQUIRED**

- Adjustable wrench (4") or ignition wrench set.
- Drill.
- Punch.
- Hole saw, 2-5/8" dia.
- Long, thin straight slot screwdriver.
- Calking gun.

MATERIALS REQUIRED

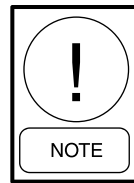
- Caulk, P/N 013-03317-050 aluminum gray or 013-03317-040 for outdoor units with champagne paint.
- Clean up supplies.

INSTALLATION CONSIDERATIONS

- Filter gage(s) can be installed in any filter segment. A filter gage can be installed across one filter bank only, installed across each filter bank in a segment, or one installed across all filter banks in a segment.
- If the unit is to have multiple filter gages then the preferred method of mounting the gages is horizontally with the prefilter gage being mounted first in airflow and the final filter gage being mounted last in airflow. If room does not allow for horizontal mounting then the gages can be mounted vertically with the prefilter gage to be mounted on the top.
- For all units with multiple filter gages, each gage should be labeled with a polyester printed label. The labels should read as follows:
 - A. "Prefilter"
 - B. "Intermediate Filter"
 - C. "Final Filter"
 - D. "Total Filter"

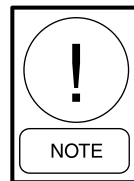
PROCEDURE

1. The filter gages are to be mounted into the filter access door or into unit side panel if space permits on filter segment.

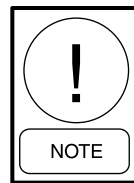


The filter gage will require a 3" O.D. surface area on the door or panel for mounting clearances and a minimum of 3" of depth behind the door panel, for proper tubing clearances.

2. Drill a 2-5/8" O.D. hole in the door or panel as close to the hinge side of the door as possible. Center the hole as follows:
 - For units up to 72" the filter gage(s) should be mounted 6" down from the top of the unit.
 - For units taller than 72" the gage should be mounted up 60" from the bottom of the unit.

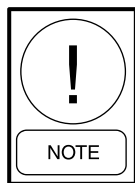


If a view port is installed in the door, the filter gage should be mounted above or below the view port to ensure best visibility.



The filter gage will be mounted to the liner cover plate by two (2) #4-40 threaded inserts and hex nuts that come with the gage.

3. Insert two #4-40 threaded inserts into the threaded holes located in the rear of the replacement gage (*see Fig. 5-105*).
4. Run a small bead of sealant around the exterior perimeter of the gage where it will seal against the filter access or unit side panel.
5. Slide gage into opening on access door or unit side panel.
6. Slide liner cover plate over two #4-40 threaded inserts.
7. Secure gage by tightening two #4-40 hex nuts, making sure gage face is level.
8. Mount static pressure ports (eyelets) by drilling a 3/16" hole in the proper location(s) (*see Fig. 5-106 for a general filter gage mounting and tubing diagram*) and inserting this eyelet through the hole then installing the 3/16" push nut retainer onto the backside of the eyelet to hold it in place.



The static pressure ports (eyelets) have to be installed “out of the air stream” to enable them to sense only static pressure and not velocity pressure. An “out of the air stream” location would be above or beside the filters. Not mounted in the face of the filter.

9. Make Tubing Connections

- The air entering side of the filter is always the high-pressure side. The downstream side is always the low-pressure side, of the filter bank.
- If the filter gage is mounted on the upstream side of the filter bank then the “HI” port of the gage is left as is to sense high-pressure and the “LO” port is tubed to the low-pressure side, of the filter.
- If the filter gage is mounted on the downstream side of the filter bank then the “LO” port is left as is, to sense low-pressure and the “HI” port is tubed to the high-pressure side of the filter bank.
- If the filter section is a combination filter assembly then the “LO” port of the prefilter gage is always tee’d into the “HI” port of the final filter gage and an eyelet is installed in the

filter track between the filters, that is tubed to this tee. The remaining ports are treated just like above.

- The prefilter is always the first filter bank in the airstream and the final filters are always the last. There may also be an intermediate filter bank, which would be between the prefilters and final filters. This configuration will require two filter segments in the same unit.
 - When the gage is door mounted, clamp the tubing to the back of the door as you run it along the hinge side. It will need to be looped so that there is enough tubing to flex around the corner of the door when it is in its full open position. The tubing will then need to be clamped to the wall panel and neatly run to the proper places.
10. Re-connect 3/16" tubing to barbed fittings on the back of the gage.
 11. Remove lens by pressing finger tips firmly against lens outer ring and turning CCW.
 12. Without any air applied, turn adjustment screw until gage reads zero.
 13. Replace lens.

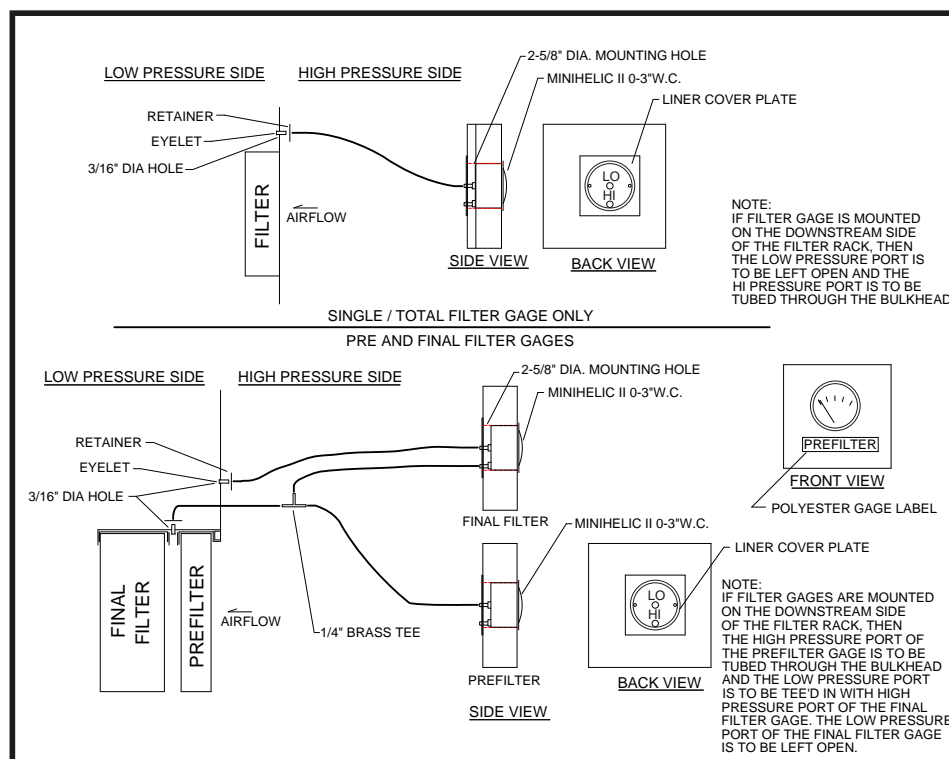


FIG. 5-106 – FILTER GAGE DIAGRAMS

LD09675

ENERGY RECOVERY WHEEL

TOOLS REQUIRED

- Standard mechanic’s hand tools.
- Metric Allen wrenches.
- Hammer.
- Drift.
- Metric socket wrench set w/ extension.
- Metric box wrench set.

MATERIALS REQUIRED

- Replacement motor and hardware kit.
- Replacement belts.
- Replacement segment.

REPLACING WHEEL SEGMENTS



Disconnect electrical power before servicing Energy Recovery Wheel.



Always keep hands away from bearing support beam when installing or removing segments. Failure to do so could result in severe injury to fingers or hand.

Wheel segments are secured to the wheel frame by a segment retainer. The retainer pivots on the wheel rim and is held in place by a segment retainer catch (see Fig. 5-108).

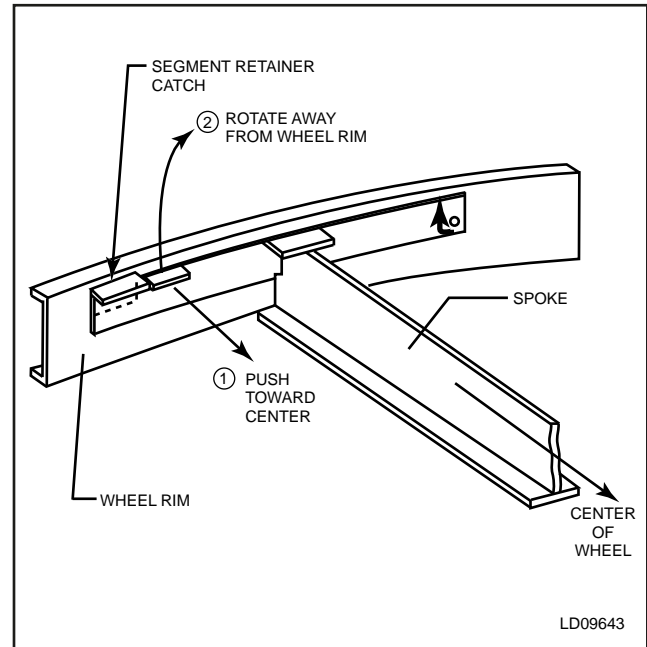


FIG. 5-108 – SEGMENT RETAINER

REMOVAL OF SEGMENTS

See Fig. 5-109

1. Disengage segment retainer from segment retainer catch (usually two per retainer) by pushing toward the center of the wheel.
2. Rotate segment retainer away from wheel rim.

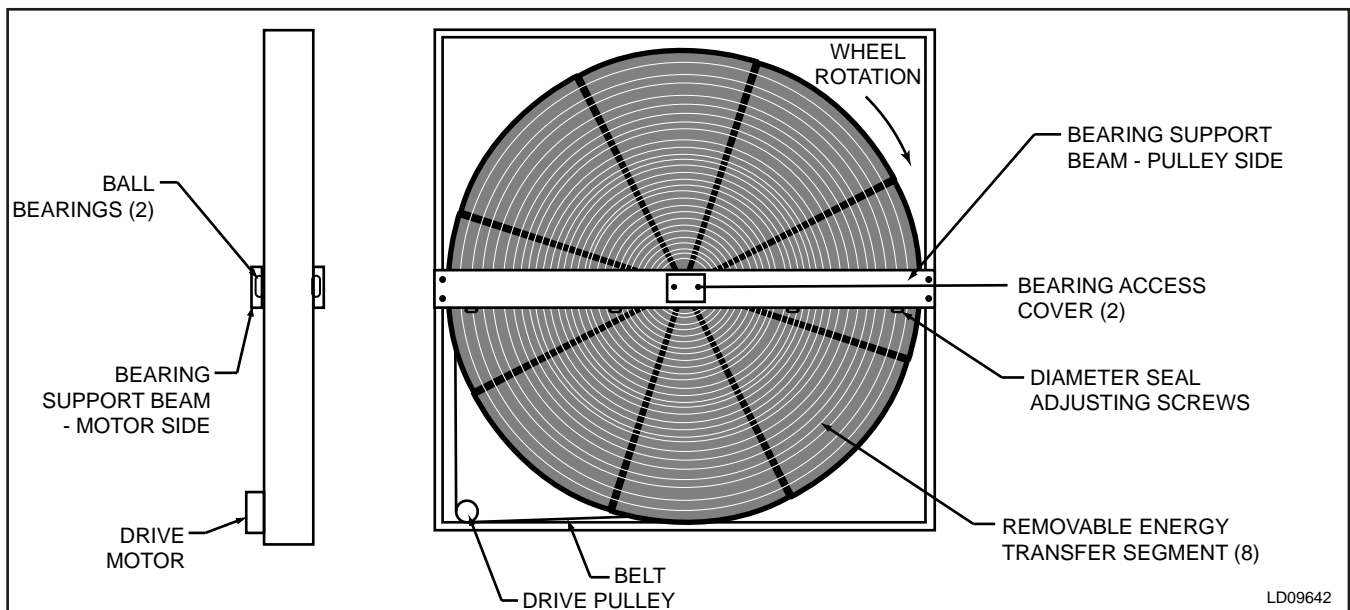


FIG. 5-107 – ENERGY RECOVERY WHEEL, PULLEY SIDE

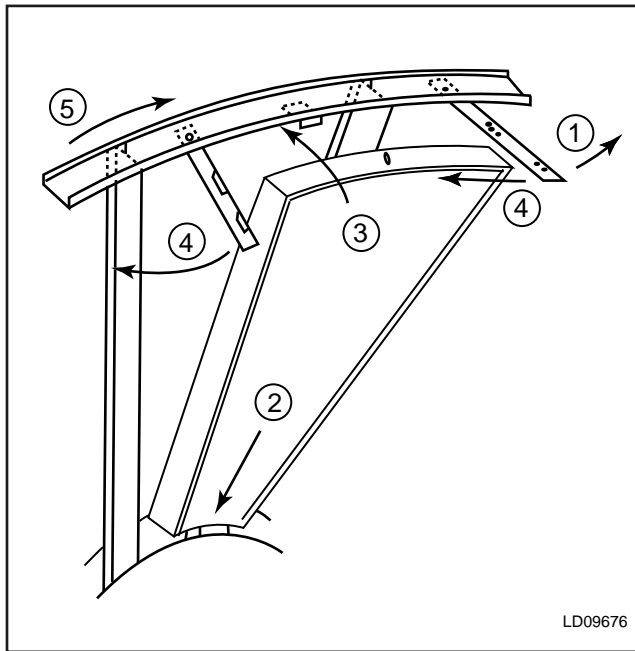


FIG. 5-109 – SEGMENT INSTALLATION

3. Pulling the segment by its two outer corners, remove the segment. It may be necessary to use a flat blade screwdriver to nudge the segment from the wheel rim. Be careful not to damage the wheel rim.
4. Rotate the segment retainer into the wheel rim so that the wheel can be rotated to access other segments.
5. It is advisable to rotate the wheel 180°. Remove the second segment in the same manner as the first. Continue removing segments in this manner until all are removed.

INSTALLATION OF SEGMENTS

See Fig. 5-109

1. Unlock two segments retainers (one on each side of the selected segment opening).
2. With the embedded stiffener facing the motor side, insert the nose of the segment between the hub plates.
3. Holding segment by the two outer corners, press the segment towards the center of the wheel and inwards against the spoke flanges. If hand pressure does not fully seat the segment, insert the flat tip of a screwdriver between the wheel rim and outer corners of the segment and apply downward force while guiding the segment into place.

4. Close and latch each segment retainer under segment retaining catch.
5. Slowly rotate the wheel 180°. Install the second segment opposite the first for counterbalance. Rotate the two installed segments 90° to balance the wheel while the third segment is installed. Rotate the wheel 180° again to install the fourth segment opposite the third. Repeat this sequence with the remaining four segments.

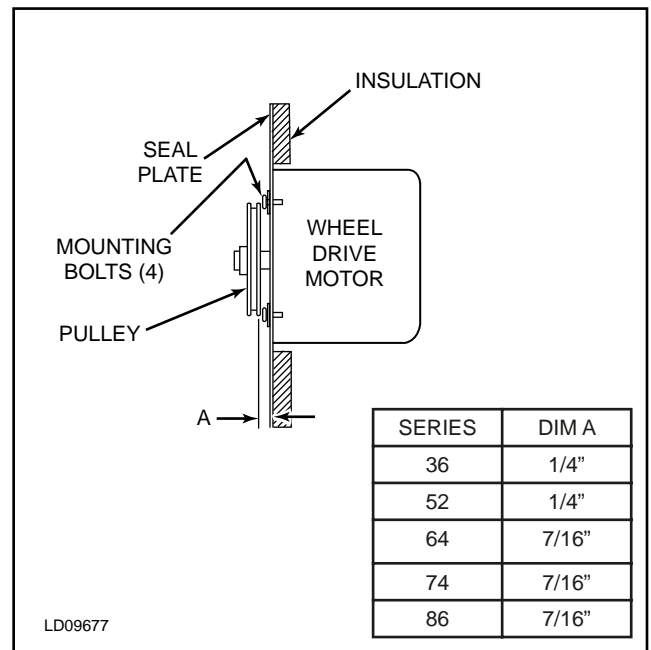


FIG. 5-110 – PULLEY LOCATION

WHEEL DRIVE MOTOR & PULLEY REPLACEMENT

See Fig. 5-110

1. Disconnect power to wheel drive motor.
2. Remove belt from pulley and position temporarily around wheel rim.
3. Loosen set screw in wheel drive pulley using Allen wrench and remove pulley from motor drive shaft.
4. While supporting weight of drive motor in one hand, loosen and remove four (4) mounting bolts.
5. Install replacement motor with hardware kit supplied.
6. Install pulley to dimension *shown in Fig. 5-110* and secure set screw to drive shaft.
7. Stretch belt over pulley and engage in groove.
8. Follow start-up procedure in Section 3.

BELT REPLACEMENT

Models ERC-36" Thru 110"

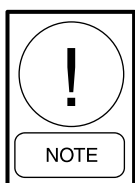
Replacement consists of wrapping the belt around the wheel rim, joining the ends by means of a single link connector, and stretching the belt around the wheel drive pulley.

1. Confirm the model number on the replacement belt kit matches the model number on the energy recovery cassette label.
2. Remove any remnant of old belt from cassette.
3. At location near pulley, attach the hook end of belt to wheel rim with tape, making sure that narrow side of "V" belt is positioned against rim and link is covered by the tape (*see Fig. 5-111 & 5-112*).



LD09858

FIG. 5-111 – ATTACHING THE HOOK END OF BELT TO WHEEL RIM WITH TAPE



Later models of ERC-74 and larger diameter wheels have a belt guide channel on the outer surface of the wheel rim into which the belt must be positioned.

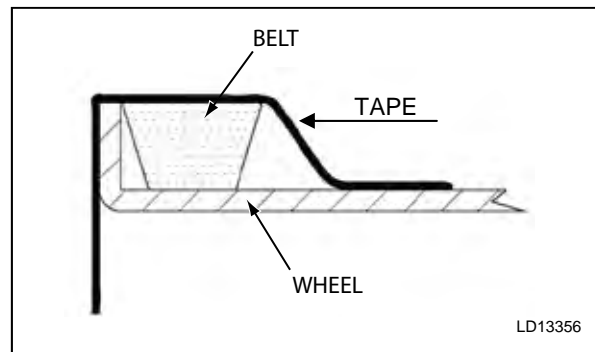


FIG. 5-112 – CROSS SECTIONAL VIEW OF HOOK END OF BELT ATTACHED TO WHEEL RIM WITH TAPE

4. Rotate the wheel clockwise while feeding belt onto wheel rim (be careful not to twist belt) until taped end returns to pulley location. Remove tape from wheel.
5. Link belt ends together with belt wrapped around wheel rim. (*See Fig. 5-113*).

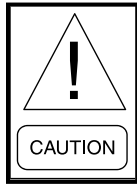


LD10016

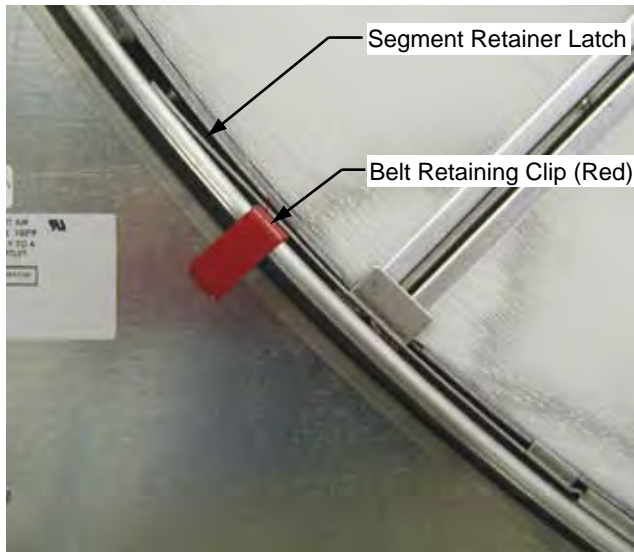
FIG. 5-113 – LINK BELT ENDS TOGETHER

6. Rotate wheel clockwise to position single link connector approximately 180° from pulley location.

- At pulley location, insert the right angle belt-retaining clip between the rotatable segment retainer latch and wheel rim at the left side of a spoke as shown in *Fig. 5-114*.



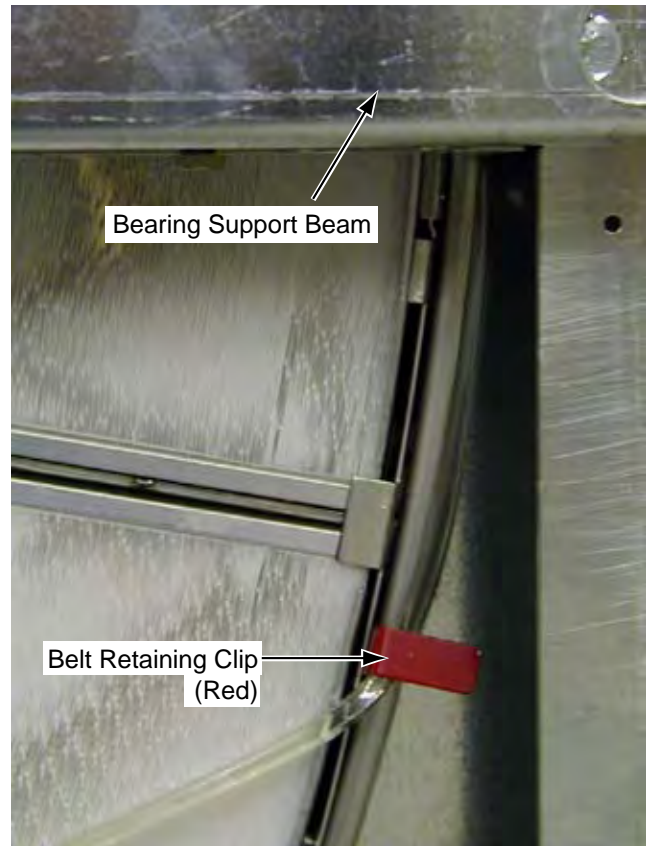
IMPORTANT: To avoid release of segment retainer latch do not insert retaining clip on other side of spoke.



LD10017A

FIG. 5-114 – INSERT RIGHT ANGLE BELT RETAINING CLIP

- Rotate wheel counterclockwise until belt retaining clip (red) is within a few inches of the bearing support beam (*see Fig. 5-115*).



LD10018A

FIG. 5-115 – RETAINING CLIP WITHIN A FEW INCHES OF THE BEARING SUPPORT BEAM

9. Lift and remove the belt from the wheel rim between a point opposite the pulley and belt retaining clip and stretch over pulley (*see Fig. 5-116*).

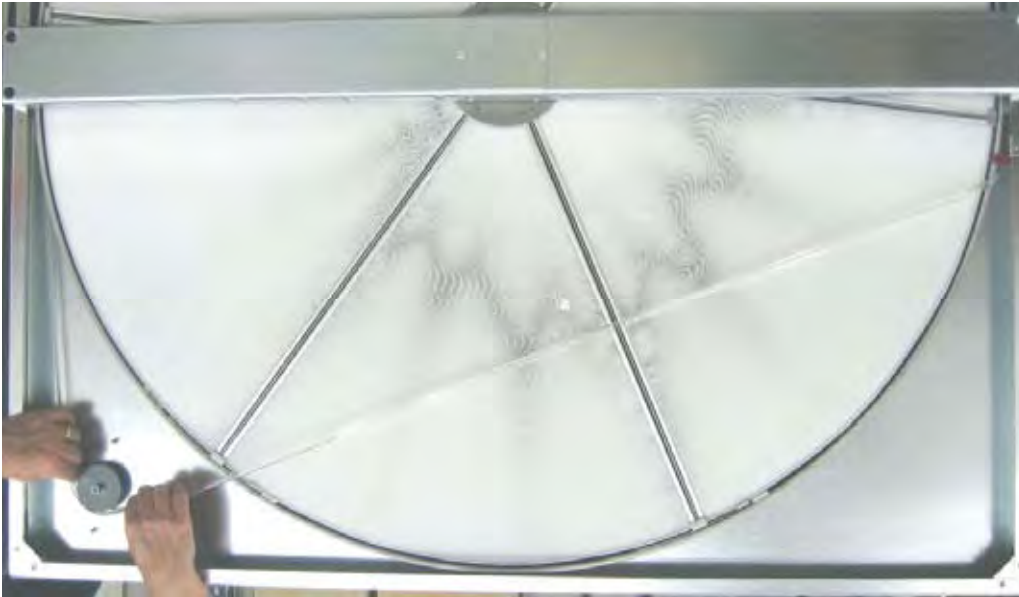
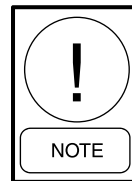


FIG. 5-116 – STRETCHING BELT OVER PULLEY

LD13360

10. Rotate wheel clockwise until the belt is fully stretched onto pulley and wheel rim.
11. Remove belt retaining clip (red) and rotate wheel clockwise a minimum of two full rotations (16 spokes) while verifying by observation and touch that belt is not twisted on wheel rim as it enters pulley, and is tracking midway between outer edge of rim and seal plate, or in belt guide channel where provided.
12. Apply power to cassette and observe belt tracking under power. If metallic “click” is heard when link rotates past the bearing support beam see note below.



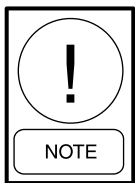
Pile seal brackets are fixed with a single screw to the cassette frame near the ends of the Bearing Support Beam. Because the height of the belt link is slightly higher than that of the urethane belt, a rare interference may occur when it passes the seal bracket. If this occurs, remove the interfering bracket (s). No measurable change of performance will occur.

TABLE 5-7 – CROSS REFERENCE; CONTINUOUS TO SINGLE LINK BELT/BELT PULLEY KITS

All Kits Includes V-belt, Belt Retaining Clip (Red) and Foil Tape. Contact local Johnson Controls Service to order parts.

| SINGLE LINK BELT | | | | |
|---|--------------|---|-------------------|-------------------|
| MODEL | WIDTH | DESCRIPTION | OLD NUMBER | NEW NUMBER |
| ERC-3615 | 1-1/2" | Single Link V-Belt Type "3-L" | 18160002 | 18160002B |
| ERC-3622 | 3" | Single Link V-Belt Type "3-L" | 18360006 | 18360006B |
| ERC-3623 | 1-1/2" | Single Link V-Belt Type "3-L" | 18160002 | 18160002B |
| ERC-3628 | 3" | Single Link V-Belt Type "3-L" | 18360006 | 18360006B |
| ERC-4128 | 3" | Single Link V-Belt Type "3-L" | 18410010 | 18410010B |
| ERC-4136 | 3" | Single Link V-Belt Type "3-L" | 18410010 | 18410010B |
| ERC-4634 | 3" | Single Link V-Belt Type "3-L" | 18460005 | 18460005B |
| ERC-4639 | 1-1/2" | Single Link V-Belt Type "3-L" | 18460005 | 18460005B |
| ERC-4646 | 3" | Single Link V-Belt Type "3-L" | 18460005 | 18460005B |
| ERC-5230 | 1-1/2" | Single Link V-Belt Type "3-L" | 181770B | 181770C |
| ERC-5245 | 1-1/2" | Single Link V-Belt Type "3-L" | 181770B | 181770C |
| ERC-5248 | 3" | Single Link V-Belt Type "3-L" | 18520017 | 18520017C |
| ERC-5262 | 3" | Single Link V-Belt Type "3-L" | 18520017 | 18520017C |
| ERC-5856 | 3" | Single Link V-Belt Type "3-L" | 18580010 | 18580010B |
| ERC-5860 | 1-1/2" | Single Link V-Belt Type "3-L" | 18580010 | 18580010B |
| ERC-5874 | 3" | Single Link V-Belt Type "3-L" | 18580011 | 18580010B |
| ERC-6445 | 3" | Single Link V-Belt Type "3-L" | 18640032 | 18640032B |
| ERC-6475 | 3" | Single Link V-Belt Type "3-L" | 18640032 | 18640032B |
| ERC-6488 | 3" | Single Link V-Belt Type "3-L" | 18640032 | 18640032B |
| ERC-6876 | 3" | Single Link V-Belt Type "3-L" | 18680010 | 18680010B |
| ERC-68100 | 3" | Single Link V-Belt Type "3-L" | 18680010 | 18680010B |
| ERC-7460 | 3" | Single Link V-Belt Type "3-L" | 18740050 | 18740050B |
| ERC-7490 | 3" | Single Link V-Belt Type "3-L" | 18740050 | 18740050B |
| ERC-74122 | 3" | Single Link V-Belt Type "3-L" | 18740050 | 18740050B |
| ERC-81110 | 3" | Single Link V-Belt Type "A" | 18810010 | 18810010B |
| ERC-81146 | 3" | Single Link V-Belt Type "A" | 18810010 | 18810010B |
| ERC-86125 | 3" | Single Link V-Belt Type "A" | 18860005 | 18860005B |
| ERC-86170 | 3" | Single Link V-Belt Type "A" | 18860005 | 18860005B |
| ERC-92135 | 3" | Single Link V-Belt Type "A" | 18920037 | 18920037B |
| ERC-92180 | 3" | Single Link V-Belt Type "A" | 18920037 | 18920037B |
| ERC-99160 | 3" | Single Link V-Belt Type "A" | 18990010 | 18990010B |
| ERC-99215 | 3" | Single Link V-Belt Type "A" | 18990010 | 18990010B |
| ERC-104195 | 3" | Single Link V-Belt Type "A" | 18040010B | 18040010C |
| ERC-104250 | 3" | Single Link V-Belt Type "A" | 18040010B | 18040010C |
| ERC110220 | 3" | Single Link V-Belt Type "A" | 18100010B | 18100010C |
| ERC-110290 | 3" | Single Link V-Belt Type "A" | 18100010B | 18100010C |
| SINGLE LINK BELT AND PULLEY KITS | | | | |
| ERC-36 | 1-1/2" | Belt/Pulley Kit Prior to 9813 | NA | 18360041A |
| ERC-36 | 1-1/2" | Belt/Pulley Kit 9814-0032 | NA | 18360042A |
| ERC-52 | 1-1/2" | Belt/Pulley "3-L"- Link V-Belt prior to 9806 | 18520031B | 18520031C |
| ERC-52 | 1-1/2" | V-Belt Link "3-L"/Pulley Kit 2.6 pitch | 181769B | 181769C |
| ERC-52 | 1-1/2" | Motor Repl/ERC 52 w/2.0 pitch pulley and 3L Link Belt | 18520009B | 18520009C |
| ERC-64 | 3" | Belt/Pulley Kit (2) 3/16" to (1) 3L" Linked V-Belt | 18640027B | 18640027C |
| ERC-74 | 3" | Belt/Pulley Kit (2) 3/16" to (1) 3L" Linked V-Belt | 18740037B | 18740037C |
| ERC-74 | 3" | "3L" Linked Belt/Pulley Kit for ERC-7460/7490/74122 | 18740060 | 18740060B |

INSTALLING DOOR SAFETY CHAIN



This procedure instructs how to install a door safety chain in high pressure areas when an inward swinging door is not possible.

PROCEDURE

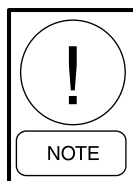
1. Attach chain to wall panel liner with a 1/4" x 3/4" self tapping screw and fender washers.
2. Attach chain, cold shut and eye snap as shown in Fig. 5-117.
3. Attach staple plate to door and liner with self-tapping screw.

TOOLS REQUIRED

- Standard mechanic's hand tools.

MATERIAL REQUIRED

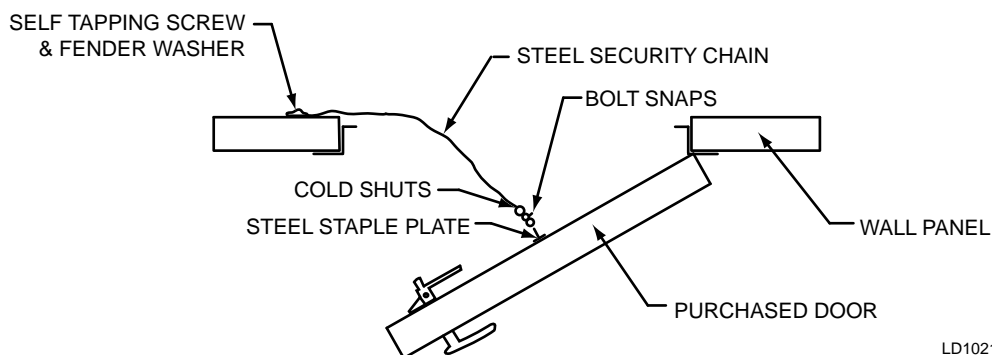
- Thread forming sheet metal screws, 1/4"-10 x 3/4", P/N 021-17722-000.
- Steel security chain, P/N TAC2401012000.
- Bolt snaps, P/N TAC2401013000.
- Steel staple plate, P/N TAC2401014000.
- Cold shuts, P/N TAC2401015000.
- Fender washer, .313", P/N TAC3303006000.



Door gap needs to be approximately 4" wide to allow access to unclasp the snap.



Center the staple plate vertically in the door. Do not interfere with the latches.



LD10211

FIG. 5-117 – SECURING DOOR CHAIN ASSEMBLY

DIRECT COUPLED DAMPER ACTUATOR REPLACEMENT AND ADJUSTMENT

PROCEDURE

See Fig. 5-118

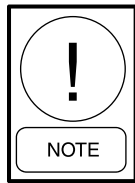
DAMPER BLADE ORIENTATION

Return Air and Mixing Dampers:

Position the blades so that they will be open once the actuator is installed. This will be the dampers spring return position. Note whether the damper shaft is rotated fully clockwise or counter clockwise.

Outside Air and Exhaust Air Dampers:

Position the damper blades so that they will be closed once the actuator is installed. This will be the dampers spring return position. Note whether the damper shaft is rotated fully clockwise or counter clockwise.



Refer to Johnson Controls installation manual for additional instructions and specifications.

TOOLS REQUIRED

Standard mechanics tool kit.

MATERIALS REQUIRED

- Actuator, locate part number on old actuator.

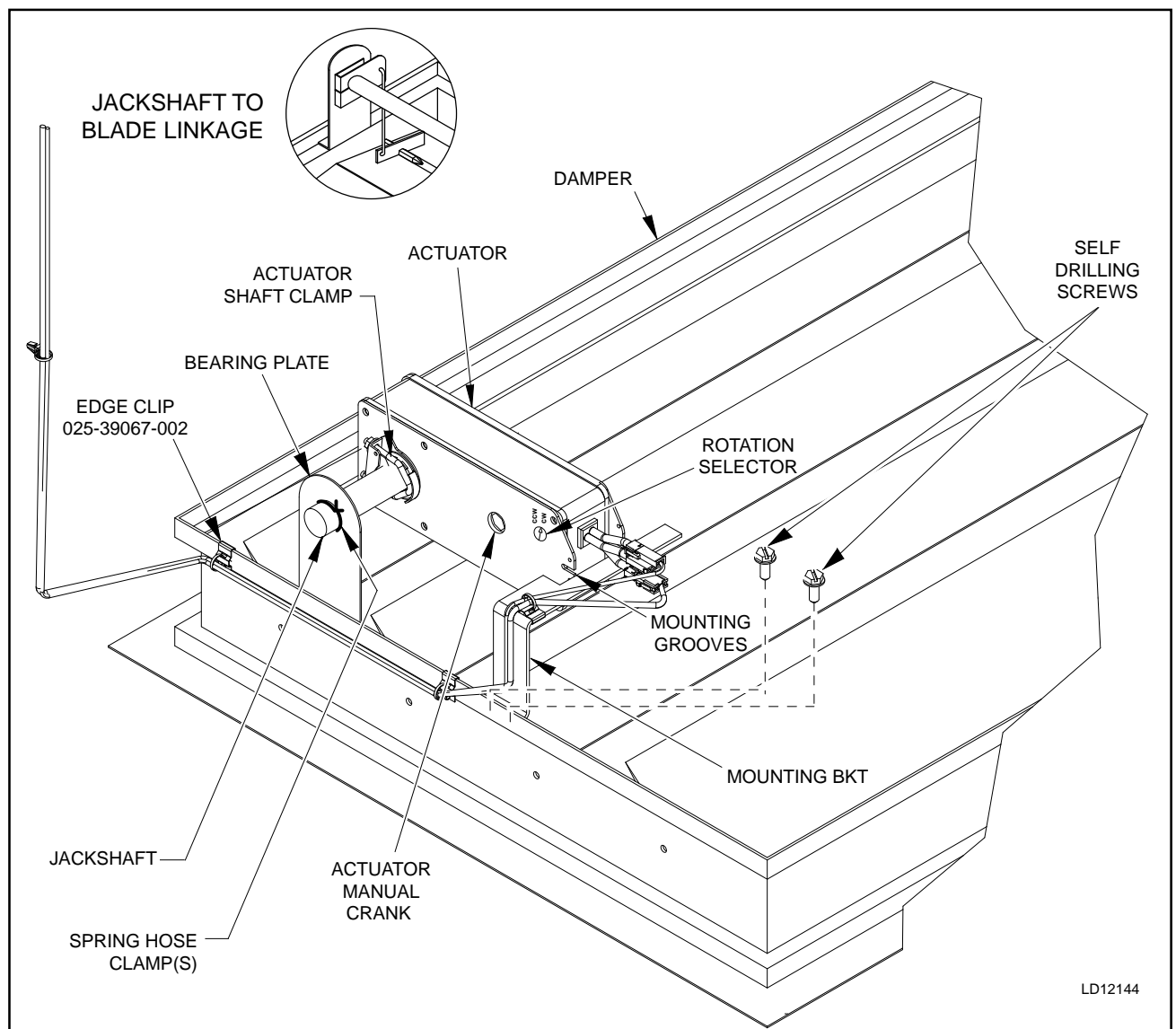


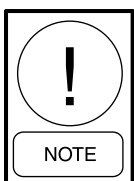
FIG. 5-118 – DIRECT COUPLED ACTUATOR ON JACKSHAFT

ACTUATOR REMOVAL

1. Loosen the actuator shaft clamp to the damper jackshaft.
2. Remove the mounting bracket by first removing the self drilling screws from damper frame, then back the bracket out of the mounting grooves on the actuator.
3. Remove the bearing plate from the damper frame and jackshaft.
4. Slide the damper actuator off the open end of the shaft.

ACTUATOR REPLACEMENT

1. Slide the damper actuator onto the open end of the shaft making sure that the proper spring return position on the face of the actuator matches the damper shafts rotation. If not, then reinstall the actuator with it flipped over.
2. Reinstall the bearing plate to the damper frame and jackshaft. Make sure spring hose clamps hold the jackshaft securely.
3. Slide the damper actuator mounting bracket into the actuator mounting grooves and fasten to the damper frame using self drilling screws.
4. Tighten the actuator shaft clamp to the damper jackshaft. Make sure at this point, the damper shaft is completely rotated to its proper position.
5. Manually operate the actuator to its fully actuated position using the crank arm provided with the actuator. Then release the spring to allow the damper to go back to its original position. This will verify the actuators spring rotation and stroke.
6. Set the damper actuators rotation selector switch to the proper rotation required to actuate the damper.



This will always be opposite the spring return rotation.

MIXING DAMPER WALL REPAIR

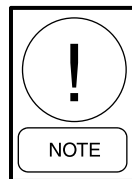
Mixing damper walls on larger YORK Solution units may become weakened in high CFM operation or if dampers, and/or dirty filters cause a higher static pressure (see Fig. 5-119). This instruction shows a recommended method of fixing this problem.

TOOLS REQUIRED

Standard mechanic's hand tools.

MATERIALS REQUIRED

- Uni-strut bracing w/ associated hardware, or equivalent.
- Angle bracket or gussets w/ associated hardware.
- Screws, self tapping, 1/4".



All parts may be found at any electrical supply house or Home Depot / Lowes store.



FIG. 5-119 – MIXING DAMPER WALL PUSHED OUT OF PLACE

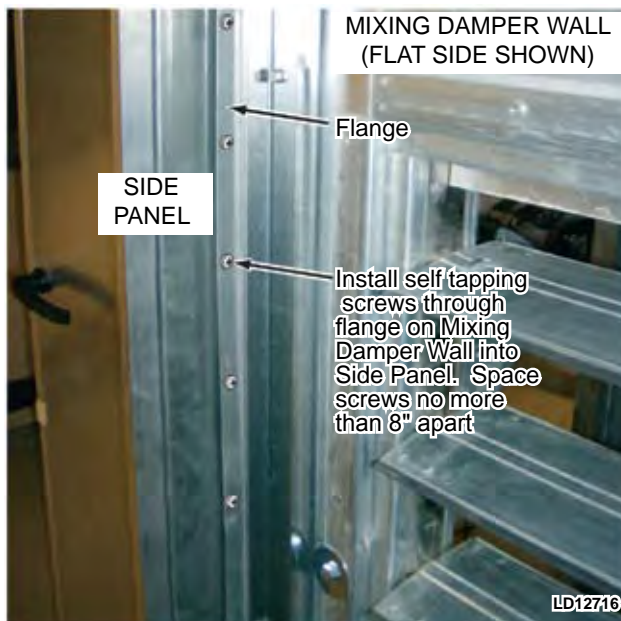
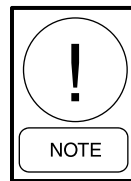


FIG. 5-120 – SECURE MIXING DAMPER WALL TO SIDE PANEL

PROCEDURE

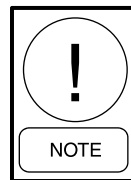
1. Push mixing damper wall back into original (vertical) position.

2. Once mixing damper wall is correctly positioned, secure the wall by running 1/4" self tapping screws through the wall flange into the side panel (see Fig. 5-120).



A maximum spacing of 8" between screws is recommended.

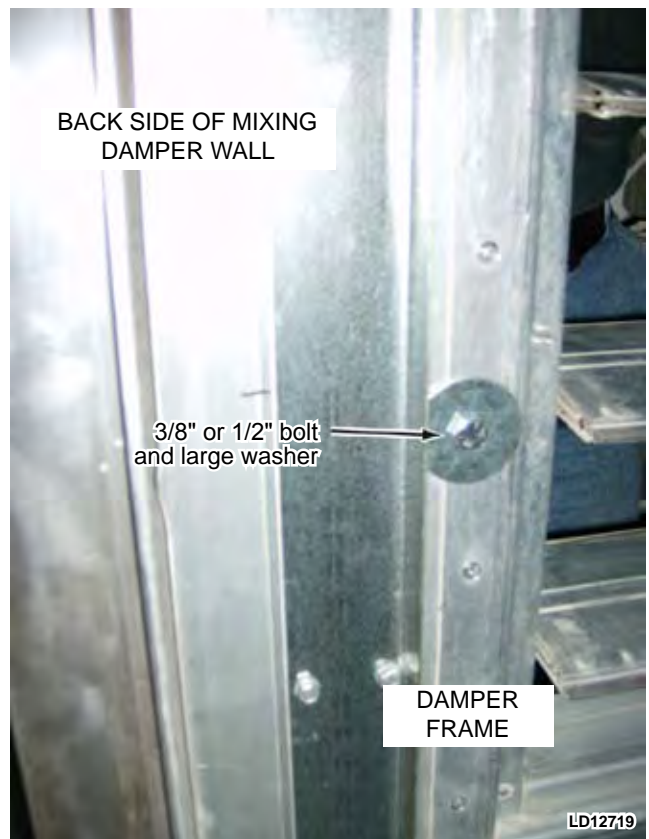
3. Once the mixing damper wall is properly positioned and secured, install bracing (standard Uni-strut or equivalent) vertically from ceiling to floor (see Fig's. 5-121 & 5-122).



Install bracing on one side of the mixing damper wall only. It is best to install it on the flat side of the wall whenever possible.



FIG. 5-121 – INSTALL BRACING TO MIXING DAMPER WALL ON EITHER SIDE OF DAMPERS



- a. Install bracing on each end of the damper and between dampers whenever possible (see Fig's. 5-121 & 5-124).
- b. Center bracing between dampers and place bracing up against each end of the dampers.
- c. Secure all bracing to mixing damper wall with associated hardware (3/8" or 1/2" bolts, nuts and large washers).

- 4. Provide additional support by installing angle brackets or gussets at the top and bottom of the bracing.

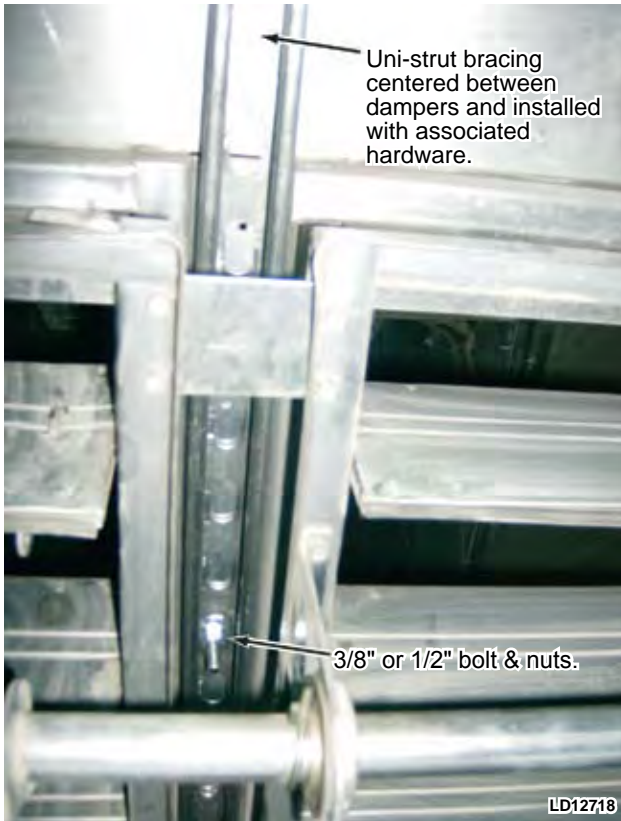


FIG. 5-122 – CENTER AND INSTALL BRACING BETWEEN DAMPERS

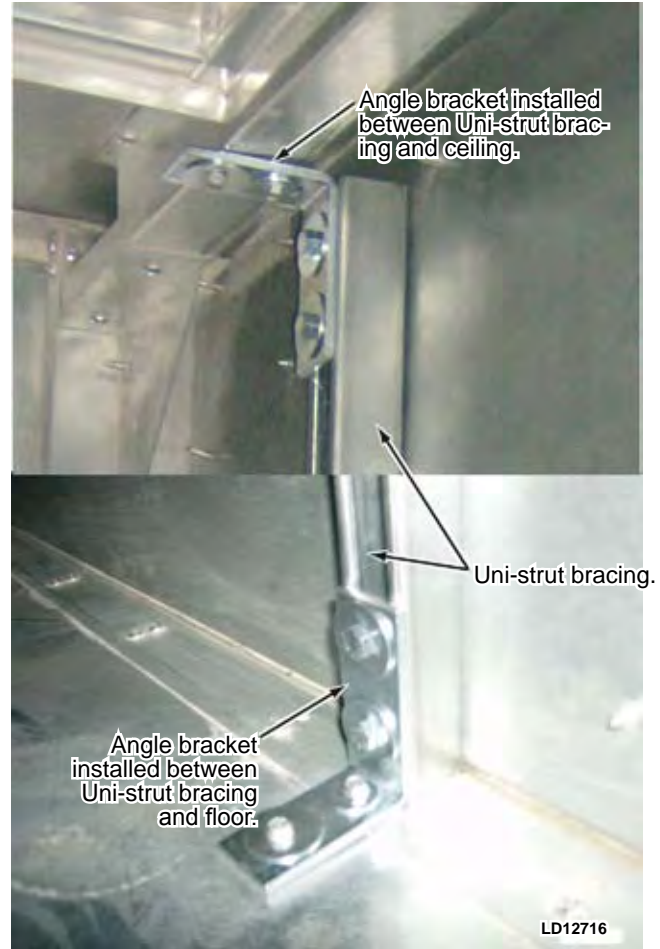


FIG. 5-123 – INSTALL ANGLE BRACKETS

POWER FLAME / ECLIPSE INDUCER FAN GASKET REPLACEMENT

This procedure tells how to replace gaskets on both Jackson & Church Eclipse and Power Flame burners.

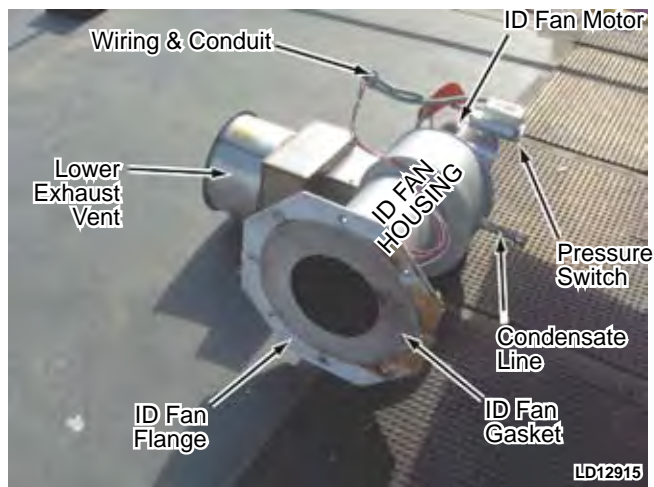


FIG. 5-124 – ID FAN ASSEMBLY COMPONENT CALL OUT

TOOLS REQUIRED

- Standard mechanic's hand tools.
- Allen wrench, 3/16".
- Pipe wrenches.
- Socket wrench with 7/16" socket.
- Metal putty knife or equivalent.
- Razor knife or equivalent.
- Caulk gun.

MATERIALS REQUIRED

- Gasket material - Call Product Service and provide (H) # to obtain proper P/N.
- Sealant, Fiber Frax LDS moldable high temp sealant, 2500°F max temp to apply, 40°F min temp, available at Grainger (P/N KM87).

PROCEDURE

1. Disconnect power to the burner and ID fan at fuse disconnects located in the control panel of the main burner (*see Fig. 5-125*).

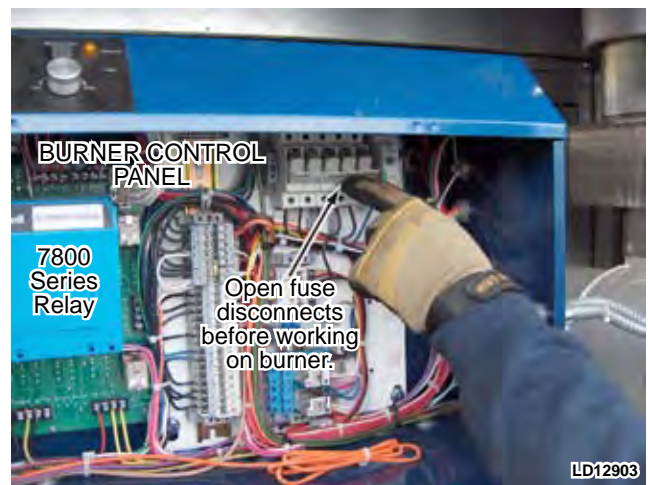


FIG. 5-125 – OPEN FUSE DISCONNECTS

2. Remove ID fan wires from terminals M-1 and M-2. Remove ID airflow switch wires from terminals ID-1 and ID-2 (*see Fig. 5-126*).

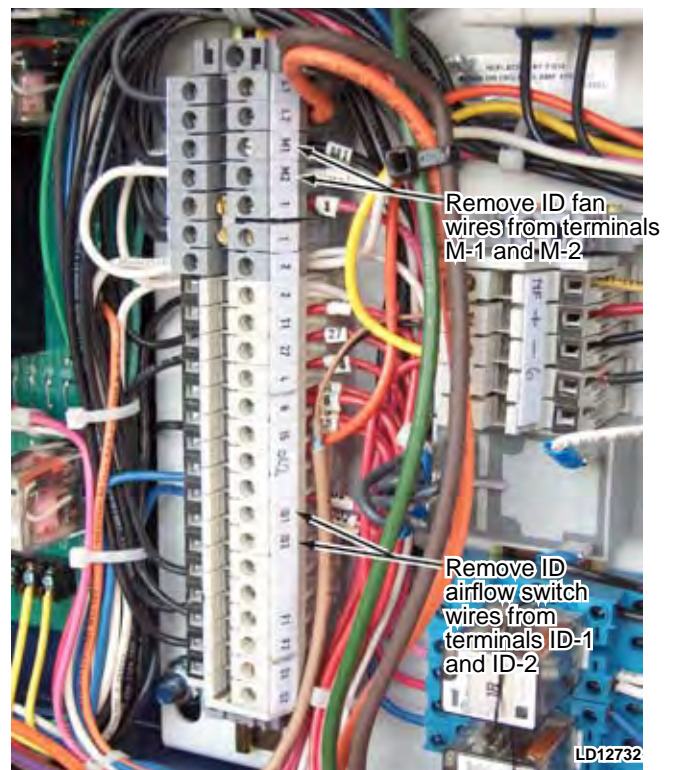


FIG. 5-126 – REMOVE ID FAN WIRES AND ID AIRFLOW SWITCH WIRES

- Remove wires completely from the control panel area. Remove Greenfield ID fan conduit from control panel (See Fig. 5-127).

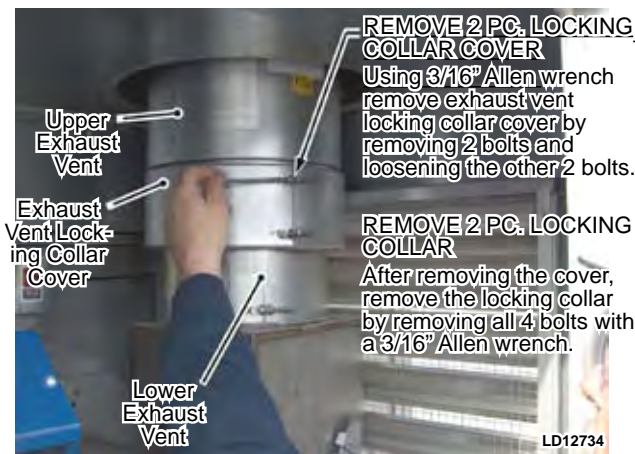


Remove wiring and conduit from control panel area.

LD12733

FIG. 5-127 – REMOVE WIRING AND CONDUIT FROM CONTROL PANEL

- With a 3/16" Allen wrench, remove the exhaust vent locking collar cover from the exhaust vent (see Fig. 5-128). Then remove two of the 3/16" Allen bolts from the locking collar (not shown). Loosen the other two 3/16" Allen bolts and remove the locking collar. Remove any old sealant from the groove on the locking collar and set the locking collar aside.



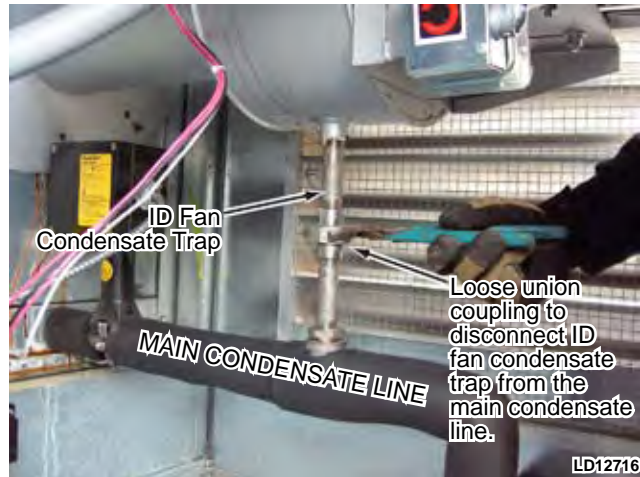
REMOVE 2 PC. LOCKING COLLAR COVER
Using 3/16" Allen wrench remove exhaust vent locking collar cover by removing 2 bolts and loosening the other 2 bolts.

REMOVE 2 PC. LOCKING COLLAR
After removing the cover, remove the locking collar by removing all 4 bolts with a 3/16" Allen wrench.

LD12734

FIG. 5-128 – REMOVE EXHAUST VENT LOCKING COLLAR COVER AND LOCKING COLLAR

- Disconnect the ID fan condensate drain from the main condensate line by loosening the union with a pipe wrench as shown in Fig. 5-129.



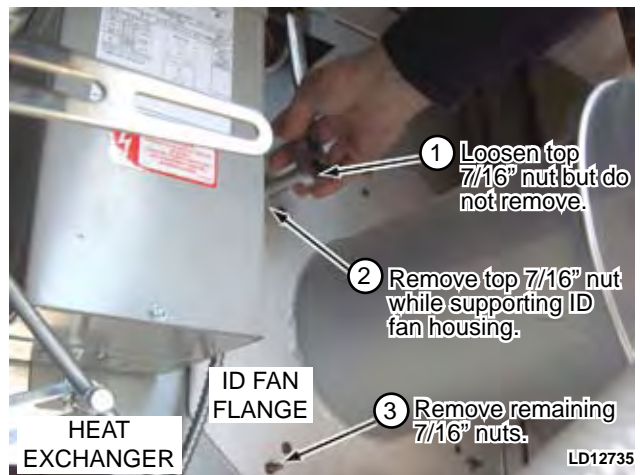
ID Fan Condensate Trap

Loose union coupling to disconnect ID fan condensate trap from the main condensate line.

LD12716

FIG. 5-129 – REMOVE CONDENSATE DRAIN TRAP

- Using a 7/16" socket wrench or nut driver, loosen the top nut on the ID fan flange where it fastens to the heat exchanger (do not remove). After removing the remaining nuts, remove the top nut while supporting the ID fan housing (see Fig. 5-130).



1 Loosen top 7/16" nut but do not remove.

2 Remove top 7/16" nut while supporting ID fan housing.

3 Remove remaining 7/16" nuts.

LD12735

FIG. 5-130 – REMOVE ID FAN FLANGE FROM HEAT EXCHANGER

- Place your left hand under the extension tube between ID fan and flange. Place the fingers of your right hand into the ID fan housing near the squirrel cage fan. Lift and slide the ID fan housing from the threaded studs on the heat exchanger (see Fig 5-131).

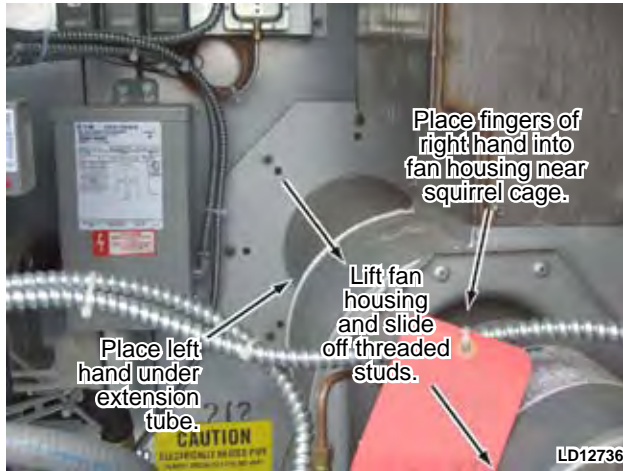


FIG. 5-131 – REMOVE ID FAN HOUSING FROM HEAT EXCHANGER

- Remove the old gasket from the ID fan flange. Remove any remaining gasket material from the ID fan flange and heat exchanger with a metal putty knife or equivalent (see Fig 5-132).



FIG. 5-132 – REMOVE OLD GASKET

- Before installing the ID fan housing, use a razor knife or equivalent to trim the new gasket so that it will fit the heat exchanger opening (see Fig 5-133).



FIG. 5-133 – TRIM GASKET

- Holding sheet metal cover panel 1/8" away from heat exchanger, apply moldable high temp sealant (Fiber Frax LDS). See Fig 5-134.

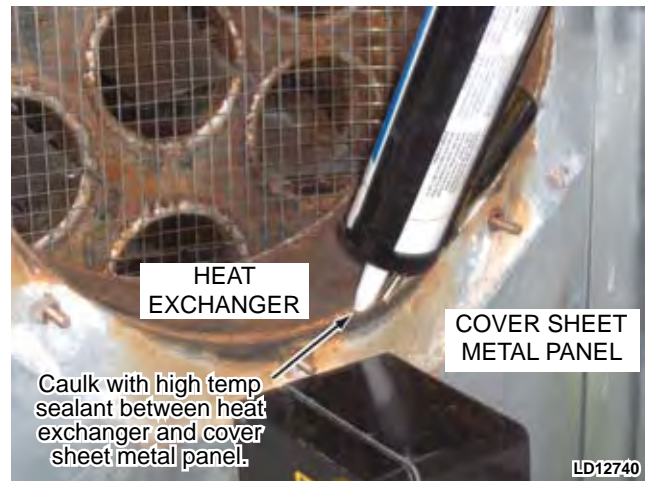


FIG. 5-134 - CAULK BETWEEN HEAT EXCHANGER AND SHEET METAL COVER PANEL

11. Install new trimmed gasket over threaded studs on heat exchanger. Caulk the entire inner gasket edge with moldable high temp sealant (see Fig. 5-135).



FIG. 5-135 – INSTALL NEW GASKET AND CAULK GASKET INNER EDGE

12. Install ID fan flange onto threaded studs on heat exchanger. Install top 7/16" nut first to hold the ID fan housing in place while installing the remainder of the 7/16" nuts (see Fig. 5-136).

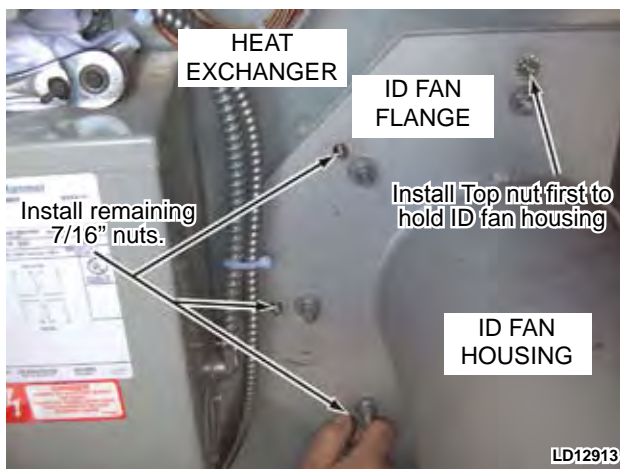


FIG. 5-136 – INSTALL ID FAN FLANGE ONTO HEAT EXCHANGER

13. Install ID fan conduit and wiring into control panel area. Attach wiring in the same positions as removed in step 2. Refer to Figs 5-126 & 5-127.

14. Apply moldable high temp sealant into both grooves of the locking collar (see Fig. 5-137).



FIG. 5-137 – APPLY SEALANT TO LOCKING COLLAR GROOVES

15. Install the locking collar and tighten the four 3/16" Allen bolts.
16. Install the exhaust vent locking collar cover and tighten the four 3/16" Allen screws (see Fig 5-128).

TABLE 5-8 – TROUBLESHOOTING TIPS

| | |
|--|---|
| DRIVE NOISE | Sheave(s) not tight on shaft(s) (motor or fan). Tighten sheave(s). ▶ |
| | Belts hitting belt guard. Adjust or tighten belt guard mounts. ▶ |
| | Belts loose. Adjust to proper tension. Belts should be checked twice during first days operation and periodically thereafter. ▶ |
| | Belts too tight. Adjust to proper tension. ▶ |
| | Belts are wrong cross section to fit sheaves. Install proper belts. ▶ |
| | Belts not matched in length on multi-belt drive. Install matched belts. ▶ |
| | Misaligned sheaves. Align sheaves properly. ▶ |
| | Belts worn. Replace belts. ▶ |
| | Motor, base or fan not securely anchored. Anchor loose components as required. ▶ |
| | Belts oily or dirty. Clean or replace belts. ▶ |
| BEARING NOISE | Defective bearing. Repair or replace bearing. ▶ |
| | Bearing needs lubrication. Lubricate bearing as required. ▶ |
| | Bearing loose on bearing support. Tighten bearing support bolts. ▶ |
| | Bearing loose on shaft. Tighten bearing to shaft. ▶ |
| | Bearing misaligned (check alignment binding.) Align properly. ▶ |
| | Foreign material inside bearing. Disassemble, inspect and clean or replace bearing as required. ▶ |
| | Fretting corrosion between bearing inner race and shaft. Clean or replace bearing as required. ▶ |
| HIGH VELOCITY AIR NOISE | Ductwork too small. Increase duct sizes to obtain proper air velocity. ▶ |
| | Fan running too fast. Check for proper fan RPM. ▶ |
| | Static pressure lower than expected. Reduce fan speed to obtain desired flow rate. ▶ |
| | Objects which are installed in a high velocity airstream can generate noise. This includes flow sensors, turning vanes etc. ▶ |
| | Registers and grilles too small. Install correct registers and grilles as required. ▶ |
| RATTLE OR WHISTLING NOISE IN AIR STREAM | Dampers obstructed. Remove obstruction. ▶ |
| | Diffusers obstructed. Remove obstruction. ▶ |
| | Loose dampers or splitters. Tighten as required. ▶ |
| | Loose grilles. Tighten grilles as required. ▶ |
| | Sharp elbow(s). Install elbow(s) with larger turning radius. ▶ |
| | Sudden expansion or contraction of ductwork. Install proper ductwork transitions. ▶ |
| | Turning vanes loose or not properly installed. Tighten and / or reinstall as required. ▶ |

Continued on next page

TABLE 5-8 – TROUBLESHOOTING TIPS (CONT.)

| | |
|--|---|
| CFM LOWER THAN REQUIRED | Fan wheel installed backwards. Install in correct position. ▶ |
| | Fan wheel rotating backwards. Reverse any two power leads to fan, to change rotation. ▶ |
| | Fan wheel not centered in inlet cones. Realign fan to center of inlet cones. ▶ |
| | Fan speed too slow. Check for proper fan RPM. ▶ |
| | Actual duct system has more resistance to flow than originally designed. Enlarge ductwork or remove restrictions to match design requirements. ▶ |
| | Dampers closed and / or splitter rod disconnected. Open dampers and connect splitter rod. ▶ |
| | Fire damper(s) closed. Open fire damper(s). ▶ |
| | Registers closed. Open registers. ▶ |
| | Insulating duct liner loose. Reattach loose duct liner. ▶ |
| | Leaks in supply ducts caused by open seams or holes in ductwork. Repair seams and / or leaks in duct system. ▶ |
| | Air filters dirty or clogged. Remove clogging debris and / or clean filters. ▶ |
| | Coils dirty or clogged. Remove clogging debris and / or clean coils. ▶ |
| | System not balanced properly. Balance system per design specifications. Pay close attention to external static pressure "design" vs. "actual". ▶ |
| | Not enough length of straight duct at fan outlet before turn or restriction. Increase length of straight duct at fan outlet or increase fan RPM to offset performance loss. Note: Observe fan RPM limits per manufacturer's guidelines. ▶ |
| Obstructions in fan discharge duct. Remove obstructions. ▶ | |
| CFM HIGHER THAN REQUIRED | Oversized ductwork. Reduce duct sizes or decrease fan RPM to obtain desired flow. ▶ |
| | Unit access door open. Close all unit access doors. |
| | System not balanced properly. Balance system per design specifications. Pay close attention to external static pressure "design" vs. "actual". ▶ |
| | Registers or grilles not installed. Install all registers and grilles per design specifications. ▶ |
| | Unit air filters not in place. Install air filters. ▶ |

Continued on next page

TABLE 5-8 – TROUBLESHOOTING TIPS (CONT.)

| | |
|--------------------------------------|---|
| MOTOR-HIGH CURRENT DRAW | Take ammeter readings on all three phases of motor to verify accuracy of ammeter. ▶ |
| | High line voltage. Consult power company. Could possibly reduce voltage by using lower transformer tap. ▶ |
| | Motor overloaded. Reduce load or use larger HP motor. ▶ |
| | Low line voltage. Consult power company. Could possibly increase voltage by using high transformer tap. ▶ |
| | Re check air distribution system and air balance report for low static pressure or air leaks in the unit or ductwork. |
| MOTOR UNBALANCED CURRENT DRAW | Unbalanced line voltage due to power supply, unbalanced electrical system loading in building, high resistance connection or undersized power supply lines. Carefully check voltage across each phase at the motor terminals with a quality, properly calibrated voltmeter. If the voltage per phase is more than 1 % out of balance, the current will be out of balance by an even greater percentage. ▶ |
| | If in doubt as to whether the problem is with the motor or incoming power supply lines perform the following test: Rotate all three input power lines to the motor by one position - i.e., move line #1 to motor lead #2, line #2 to motor lead #3 and line #3 to motor lead #1. If the unbalanced current draw pattern follows the input power lines the problem is the power supply. Correct the voltage balance of the power supply. If the unbalanced current draw pattern follows the motor leads the problem is a defective motor. Replace motor. ▶ |
| MOTOR-EXCESSIVE VOLTAGE DROP | Excessive starting or running load. Reduce load or install larger motor. |
| | Inadequate power supply. Consult power company. |
| | Undersized power supply lines. Increase supply line sizes. |
| | High resistance connections. Eliminate poor connections. |
| MOTOR - RUNS EXCESSIVELY HOT | Motor overloaded. Reduce load or install larger motor. ▶ |
| | Blocked ventilation. For ODP motors blow out internal ventilation passages with air pressure and eliminate external interference to motor ventilation. For TEFC motors clean external ventilation system and check motor ventilation fan. |
| | High ambient temperature over 40°C or 105°C. Reduce ambient temperature or provide outside source or cooler air. |
| | Unbalanced current draw. Balance supply voltage. Check motor leads for tightness. ▶ |
| | Motor single phase condition. Eliminate single phasing problem. |
| MOTOR -WILL NOT START | Motor single phase condition. Shut power off. Eliminate single phasing condition. Check motor leads for tightness. ▶ |
| | Rotor or bearings locked or frozen. Shut power off. Check shaft for freeness of operation. Replace bearings. Check overload relay sizing and verify overload relays are in each of the 3 phases of the starter. ▶ |

Continued on next page

TABLE 5-8 – TROUBLESHOOTING TIPS (CONT.)

| | |
|--|---|
| MOTOR -RUNS NOISY UNDER LOAD | Motor single phase condition. If motor cannot be restarted it is single phased. Eliminate single phasing condition. |
| | Motor single phase condition. Check overload relay sizing and verify overload relays are in each of the 3 phases of the starter. |
| | Motor shaft bearing damaged. Replace bearing. ▶ |
| | Supply voltage high or inconsistent supply frequency. Adjustable frequency controllers can generate motor noise. |
| MOTOR – LOAD SPEED CONSIDERABLY BELOW NAMEPLATE SPEED | Motor overloaded. Reduce load or increase voltage. |
| | Excessively low voltage. A reasonable overload or voltage drop will reduce motor speed only 1 - 2%. A drop of any greater magnitude would be questionable. |
| | Inaccurate method of measuring RPM. Check motor using another RPM measuring device or method. ▶ |
| MOTOR - EXCESSIVE VIBRATION | Motor mounting loose. Check motor mounting and be sure it is tight and solid. |
| | Load unbalanced. Disconnect belt and restart motor. If vibration stops, the load is unbalanced. Balance the load. |
| | Remove drive sheave and tape 1/2 key in shaft keyway and restart motor. If vibration stops the sheave is unbalanced. Replace sheave. ▶ |
| | If after checking all other options above and motor still has excessive vibration, the motor is unbalanced. Replace motor. ▶ |
| MOTOR - NOISY BEARINGS | Bearing produces smooth mid-range hum. Normal fit, bearing is OK. |
| | High whine. Internal fit of bearing too tight. Replace bearing and check it. ▶ |
| | Low rumble. Internal fit of bearing too loose. Replace bearing, check fit. ▶ |
| | Rough clatter. Bearing destroyed. Replace bearing. ▶ Avoid mechanical damage, excessive greasing, wrong grease, ▶ solid contaminants and water running into motor. |
| MOTOR - MECHANICAL NOISE | Determine if noise is from motor or fan. Isolate motor from fan and check difference in noise level. |
| | Fan noise transmitted to motor through drive. Reduce fan noise or dampen noise transmission to motor. |
| | Be sure fan vibration isolator shipping brackets are removed. If still in place remove shipping brackets to allow vibration isolation of fan and motor. ▶ |
| NO ELECTRIC HEAT | Manual reset thermal cutout in electric heater control circuit tripped. Check reason for tripping and correct. Reset manual cutout switch. |
| | Airflow switch interlock not closed. Check airflow sensing tube for proper location in airstream and for possible damage. Repair or replace airflow switch and / or sensing tube as required. |
| | Broken electric heating element. Replace element. |
| | Heat limiters blown. Replace heat limiters. |
| | Electric heater circuit fuses blown. Replace fuses. |
| | Defective electric heating circuit contactor. Repair or replace contactor as required. |

Continued on next page

TABLE 5-8 – TROUBLESHOOTING TIPS (CONT.)

| | |
|---|---|
| NO HOT WATER OR STEAM HEAT | Defective hot water or steam valve actuator motor. Replace actuator motor. ▶ |
| | Broken control linkage from actuator to valve assembly. Repair or replace actuator linkage. ▶ |
| | Defective hot water or steam control valve. Replace valve. ▶ |
| WATER CARRY-OVER FROM WETCOOLING COIL ONTO FLOOR, MOTOR OR FAN HOUSING | Airflow too high – See “CFM HIGHER THAN REQUIRED” ▶. |
| | Drain pan full – See “DRAIN PAN NOT PROPERLY DRAINING”. ▶ |
| | Water spraying out of drain pan – “DRAIN PAN NOT PROPERLY DRAINING”. ▶ |
| | Coil Bulkhead penetrations – Be sure any field penetrations are sealed. ▶ |
| | If intermediate drain pans on the coil face are present – Be sure they drain properly, checking for debris and damage. ▶ |
| | Check auxiliary drain pans under coil headers – Be sure they drain properly into the main drain pan, checking for debris or damage. ▶ |
| WATER INSIDE UNIT | If unit shipped in more than one piece – Be sure these field reassembly joints are properly sealed against rain water and air leaks. ▶ ▶ |
| | If field piping or electrical conduits penetrate the unit – Be sure they are sealed properly. The electrical conduits must be sealed internally to prevent airflow and moisture condensation. ▶ |
| DRAIN PAN NOT PROPERLY DRAINING | Be sure trap is installed and of correct size and construction. ▶ |
| | Be sure unit is installed level on curb, steel or pad. ▶ |
| | Check the segment which houses the drain pan. Be sure it is under the correct pressure (positive or negative) and that pressure does not exceed the design for that segment per the design data sheet in the submittal. |
| PRE-FILTERS ARE WET | If outside air hoods are shipped loose – Be sure they are properly installed and sealed at top flange. Some hoods may be shipped with mist eliminators or prefilters to be mounted in the hood openings when hoods are being installed. ▶ |
| | If unit has outside air opening – Be sure airflow does not exceed the design for outside air per the design data sheet in the submittal. |

TABLE 5-8 – TROUBLESHOOTING TIPS (CONT.)

| | |
|--|--|
| FILTERS OUT OF FILTER RACK | Check for dirty filters. Filters may load much more rapidly if construction is on going in the immediate area, if certain area vegetation releases airborne substances or if insect swarms are present. ▶ |
| | Check for wet filters or snow loading – See <i>PRE-FILTERS ARE WET</i> . |
| | Check for damage to the filter racks, filter frames, filter headers or filter tracks. ▶ |
| | Check for missing filter clips or latches when required. ▶ |
| | Be sure air pressure drop (APD) across the filters does not exceed design – See <i>Engineering Guide Form 100.10-EG2, "FILTER APD"</i> . |
| AIR MODULATOR (AIRMOD) WILL NOT OPERATE | Verify external safety circuit is wired in at correct terminals and it has continuity. |
| | Verify control signal is wired in (or piped in if pneumatic) at correct terminals and is of correct type. |
| | <i>Refer to Installation, Operation, Programming, Troubleshooting and Technical Support information packed inside Airmod.</i> |
| AIR LEAKS | |
| UNIT SWEATING | |
| DAMPERS NOT OPERATING PROPERLY | |
| FAN VIBRATION ▶ | Misalignment of drive components. |
| | Loose foundations or mounting structure. (Resonance's). |
| | Foreign material attached to rotating components. |
| | Damaged rotating components. (Bearings, shaft, fan, wheel, sheaves). |
| | Broken, loose or missing setscrews. |
| | Loose belts. |
| | Vibration may be coming from a source other than the fan. Stop the fan and determine if the vibration still exists. Disconnect the driver motor from the fan and operate it by itself to determine if it produces vibration. |
| | Water accumulating in airfoil blades. |
| | Fan is operating in stall or unstable flow region (<i>see fan curve</i>). |
| | Loose bolts on bearings, housing, hub or sheaves. |
| | Loose locking device on bearing. |
| Finally, have the vibration professionally analyzed. | |
| DOOR BINDING | Check for obvious damage. |
| | Check unit location for flat level surface of curb or housekeeping pad. Uneven surface will rack unit causing door to bind. |
| | Check door frame for bow or twist. |
| | Measure corner to corner of door and frame independently. If frame is out of square, remove and re-install door frame and door as an assembly. If door is out of square, replace door frame assembly. |

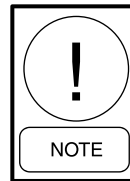
6.0 WIRING SCHEMATICS



External wiring, unless specified as an optional connection in the manufacturer's product line, is not to be connected inside the control panel cabinet. Devices such as relays, switches, transducers and controls may not be installed inside the control panel. No external wiring is allowed to run through the control panel. All wiring must be in accordance with Johnson Controls published specifications and must be performed only by qualified Johnson Controls personnel. Johnson Controls will not be responsible for damages/problems resulting from improper connections to the controls or application of improper control signals. Failure to follow this will void the manufacturer's warranty and cause serious damage to property or injury to persons.



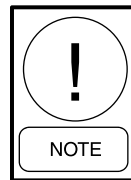
Rotating parts and electrical shock hazards exist. Lock out and tag out the fan motor(s) and heat power disconnects before servicing. FOLLOW THE LATEST "LOCKOUT TAGOUT" PROCEDURE. Failure to follow proper safety precautions may result in serious injury or death. Refer to general safety guidelines and safety symbols located at the front of this Manual. ►



The purpose of drawings in this section is to aid in installation, startup and troubleshooting. Actual wiring configuration may deviate from these drawings and are subject to change without notice.



DO NOT PENETRATE WIREWAYS in any manner. These sheet metal channels, which run along the top panel, contain electrical wires and connections. Electrical shock and/or damage to the unit may result.



Never use silicone caulk/sealant or caulk/sealant containing silicone in or on any air handling equipment. [Only exception is when provided (high temperature) with gas heat venting].

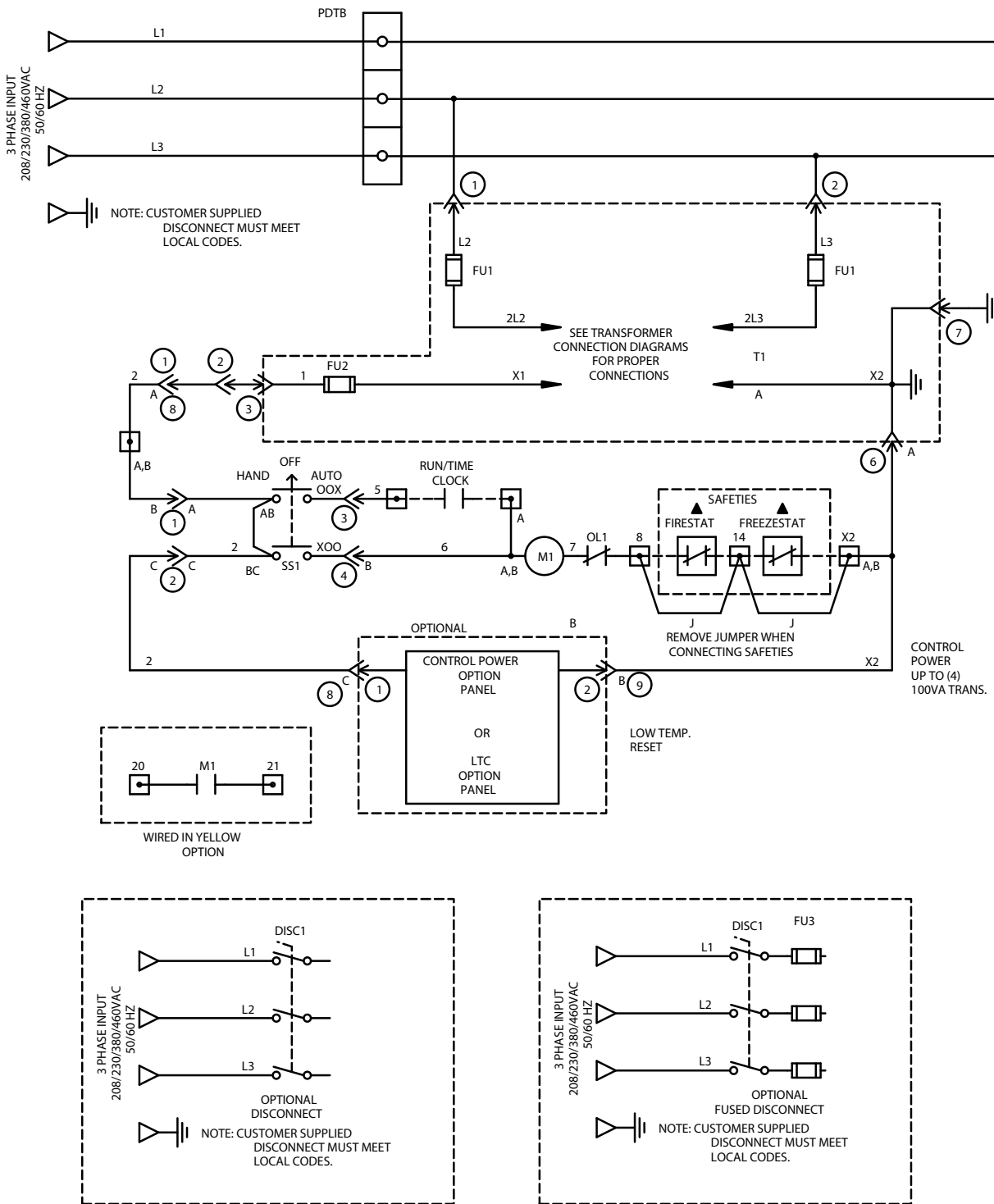
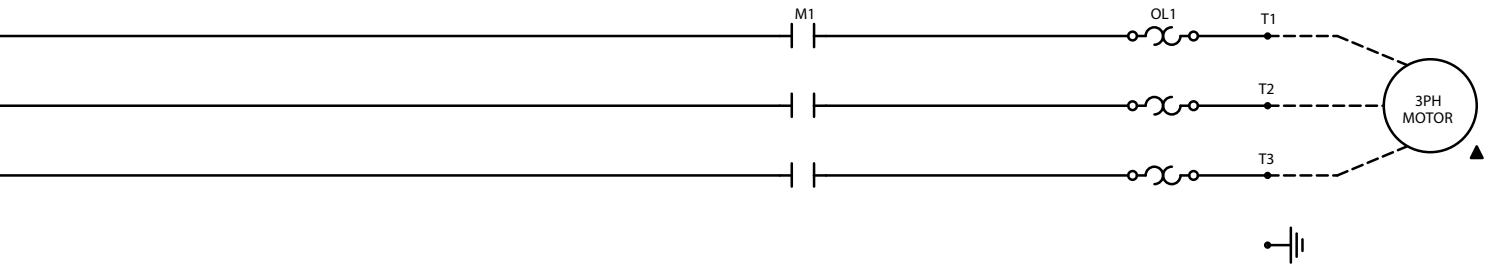
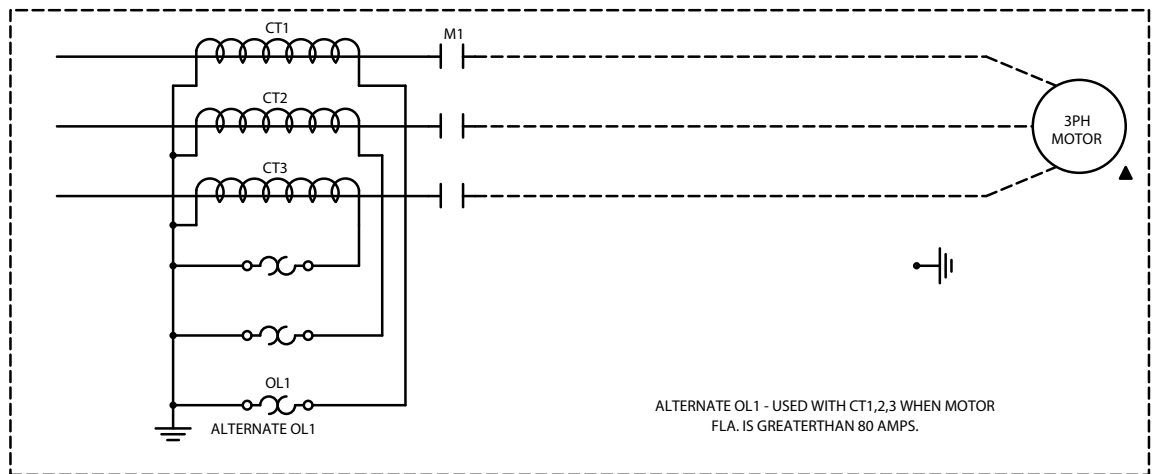


FIG. 6-1 – FULL VOLTAGE STARTER (204194)



NOTES:

- ◻ - TERMINAL POINT
- ▲ - REMOTE DEVICE (BY OTHERS)



ALTERNATE OL1 - USED WITH CT1,2,3 WHEN MOTOR FLA IS GREATER THAN 80 AMPS.

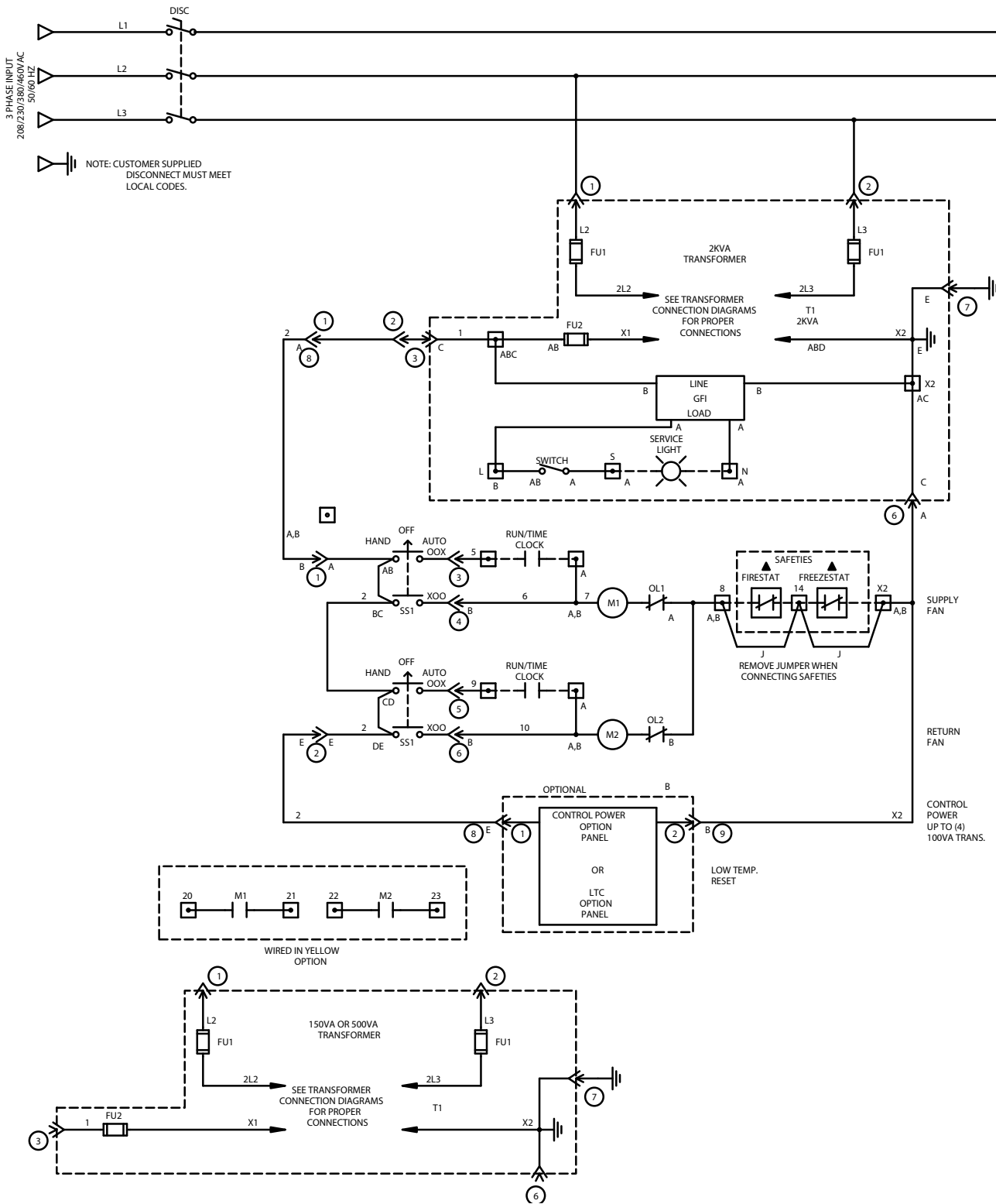
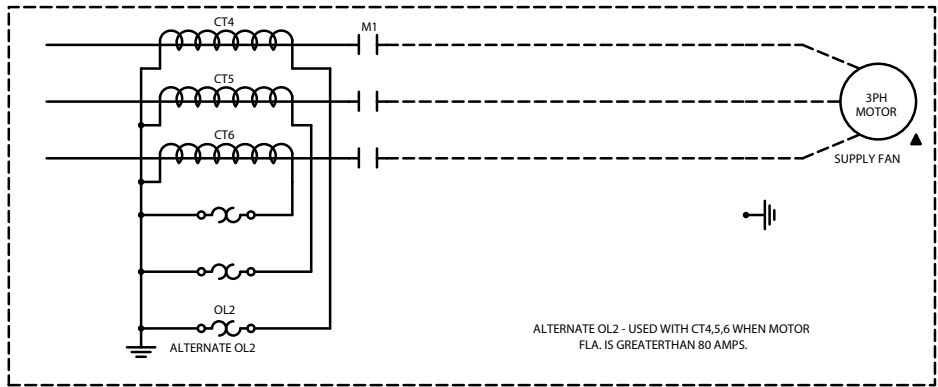
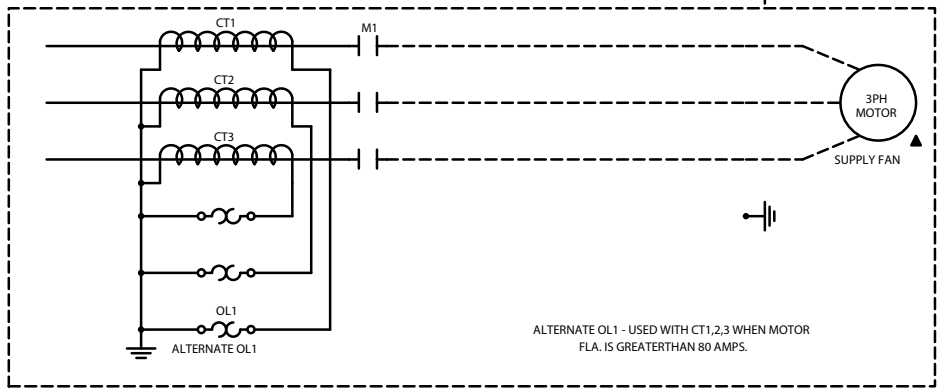
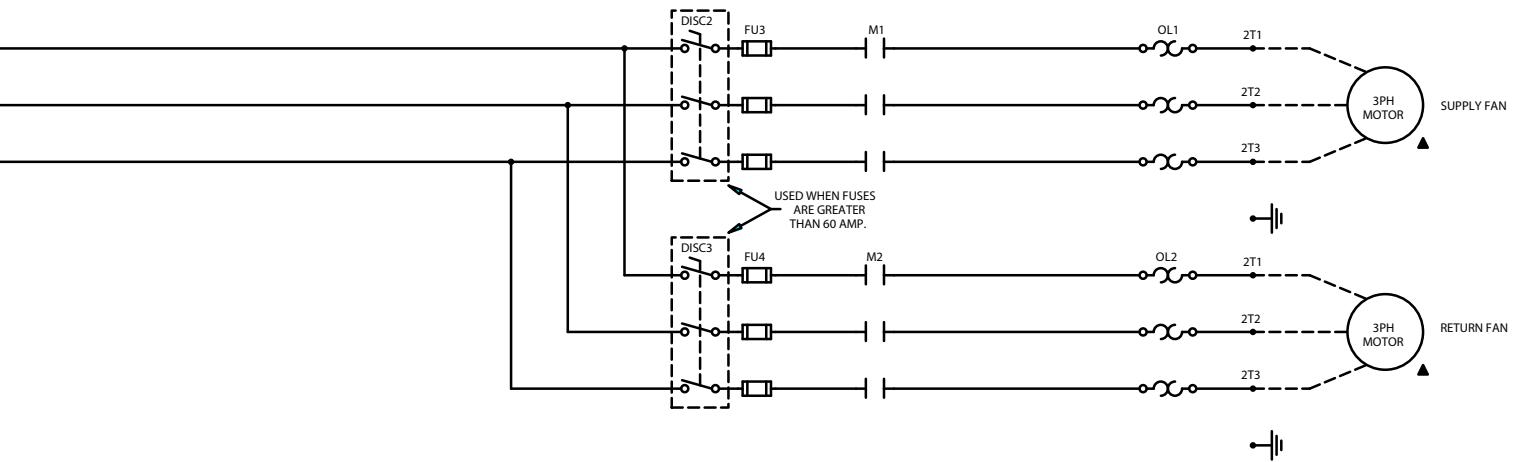


FIG. 6-2 – FULL VOLTAGE STARTER WITH SINGLE POINT POWER CONNECTION (204195)



NOTES:

- ◻ - TERMINAL POINT
- ▲ - REMOTE DEVICE (BY OTHERS)

Panel part # 025-39132-000 or 025-39133-000

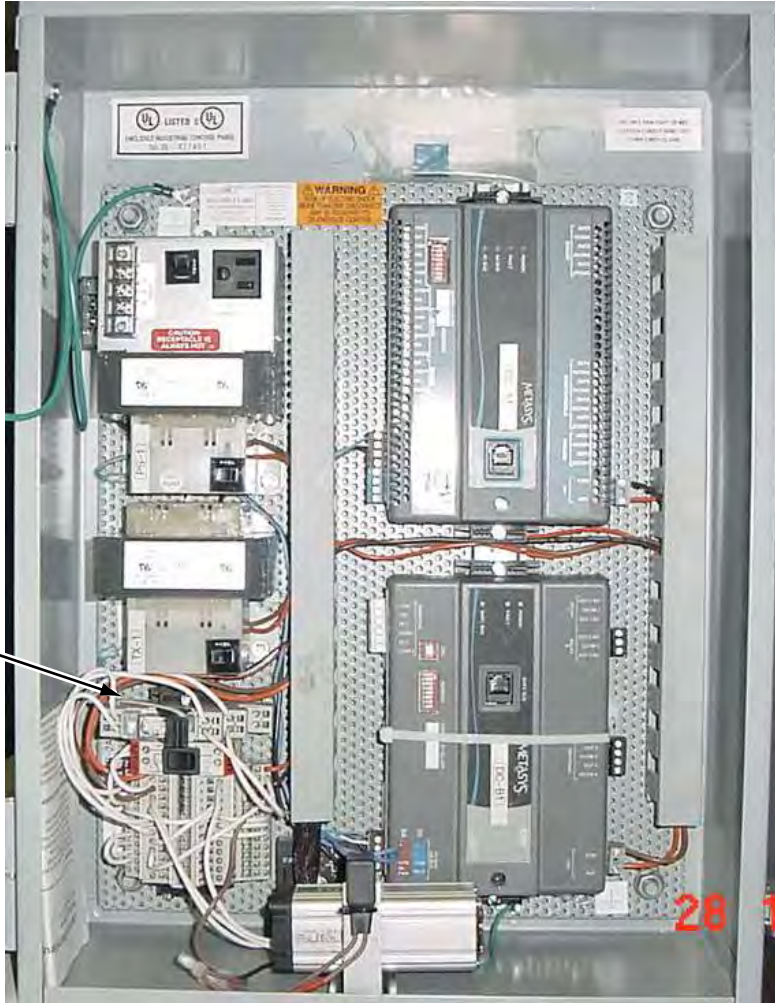
1. This kit will be required for some of the Johnson FEC control standards (100% outside air).

2. install relay (025-39136-001) on din rail provided in panel at the location shown.

Components on din rail will need to be shifted down to allow relay to fit.

3. Wire relay as shown on the diagram below using the wire called for in kit.

Install Relay



LD12500

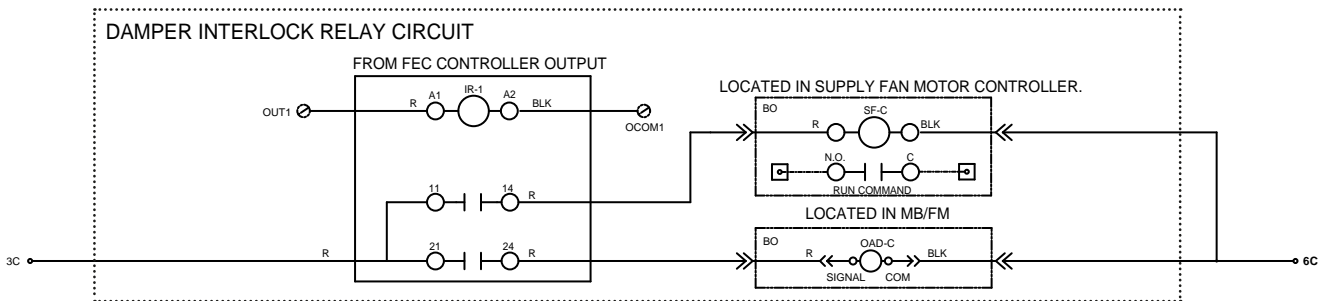


FIG. 6-3 – OUTSIDE AIR DAMPER KIT - RELAY INSTALLATION

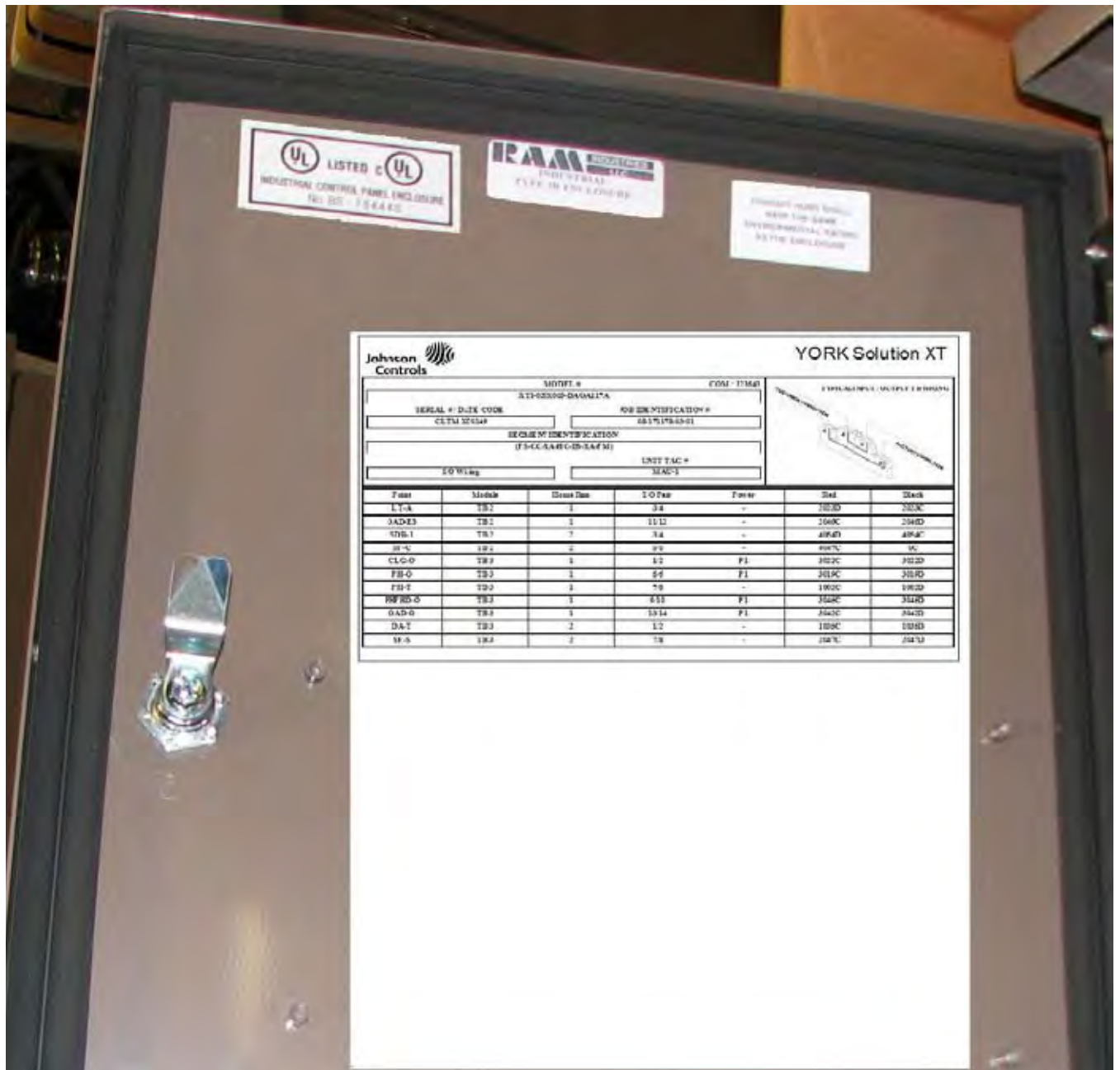


FIG. 6-4 – TERMINATION CHART INSIDE ENCLOSURE DOOR

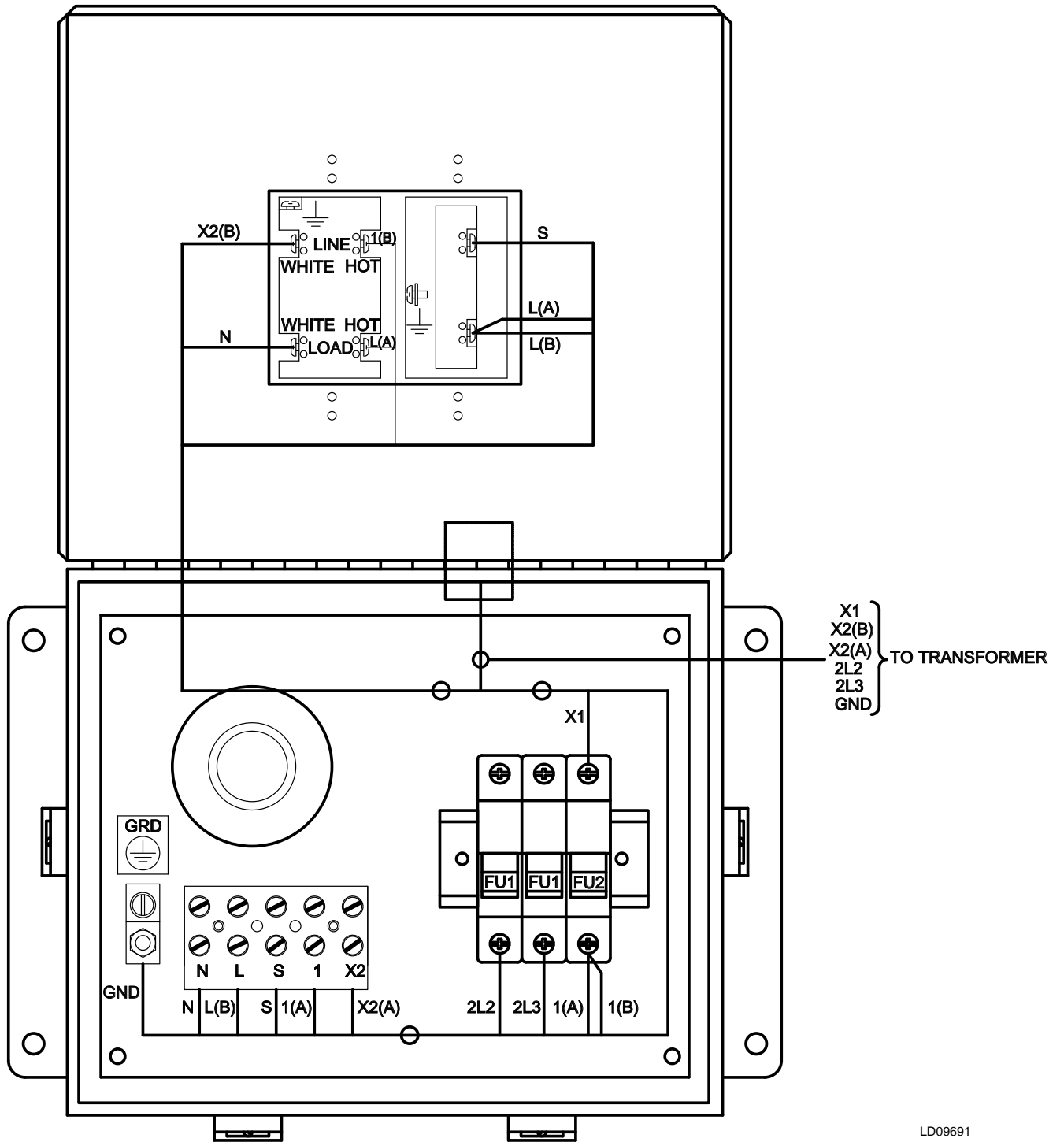
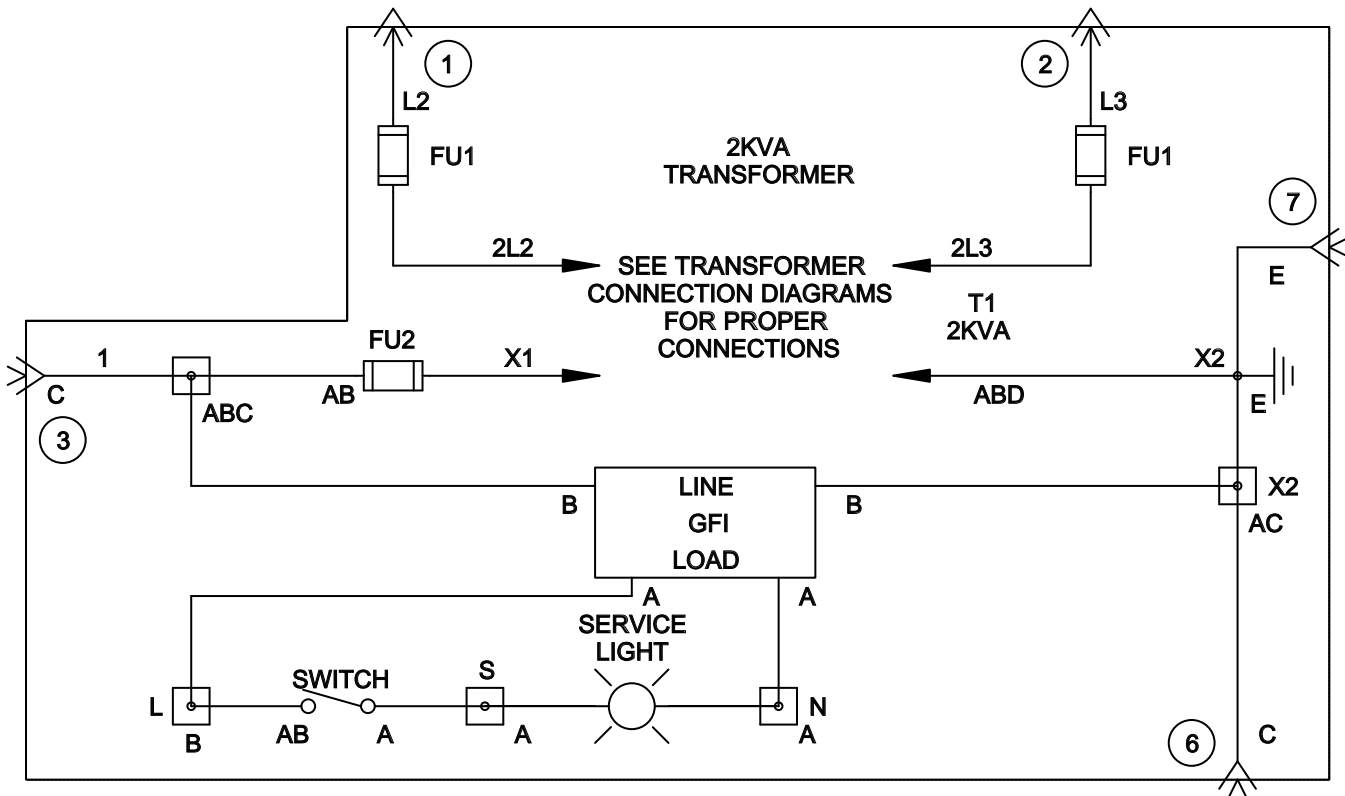


FIG. 6-6 – TRANSFORMER ENCLOSURE WIRING DETAIL SHOWN OPEN

LD09691



LD09692

FIG. 6-7 – TRANSFORMER WIRING DIAGRAM

085-013-001 NEW

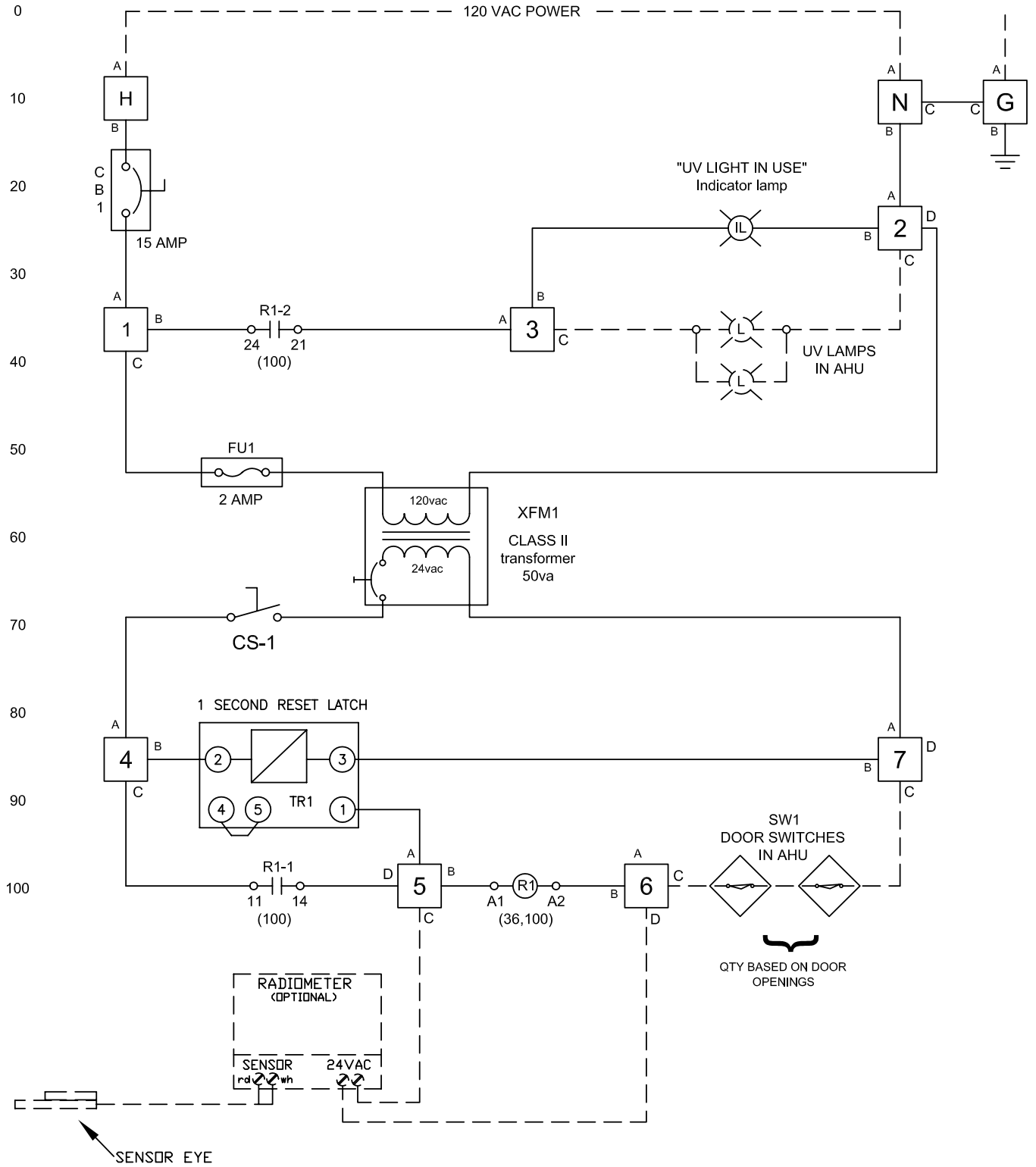
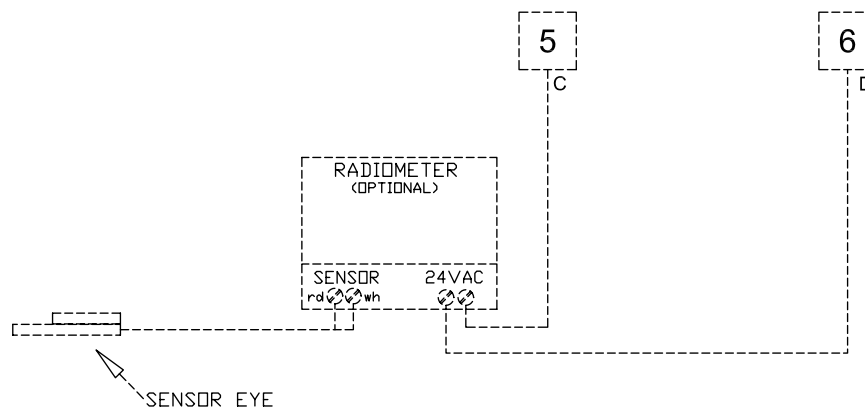


FIG. 6-8 – UV CONTROL PANEL WIRING - 8A

OPTIONAL RADIOMETER WIRING.



Sequence of Operation:

Disconnecting Means of UV lighting will be accomplished by "CB1" internal to the panel. "CB1" is cable of being locked out by panel latching mechanism.

"SW1" is a proximity switch with a magnet, which will close a set of normally open contacts. The magnet will engage the "SW1" contact whenever it is within 1/2" of the switch.

"TDR1" is a one second (1sec) time delay relay having normally open contacts. When power is initiated, its contacts will close for one second then re-open. To reset, power must be removed from "TDR1"

"C1" is a dpdt 24vac control relay, used to seal-in its coil and provide interlocking means to the UV lights.

If all doors are closed, all the "SW1"s will allow "C1" to energize, as long as power is available.

By selecting "CS-1" to the "on" position, the 24vac control power circuit will be energized. As long as all doors with door switches (SW1) are closed and upon detection of power to the 1 second time-delay relay (TDR-1), the "TDR-1" normally open contacts will close for one second, energizing the contactor "C1". "C1" will energize and "seal-in" its coil via an auxiliary contact. After one second, "TDR-1" will de-energize, but "C1" will remain energized. Should any one door

having "SW1" mounted, were to open, "C1" will de-energize, deactivating the UV lamps.

Closing all doors will not turn on UV lights. "CS-1 will be required, to be cycled "Off" then back "On" to allow the lights to come back on. If power is removed from the UV control panel and re-energized (such as when power fluctuates off then back on), the UV lights will reactivate automatically.

The "IL" "UV LIGHT IN USE" indicator lamp will allow the User to know if the lights have been energized.

FIG. 6-9 – UV CONTROL PANEL WIRING - >8A (CONT)

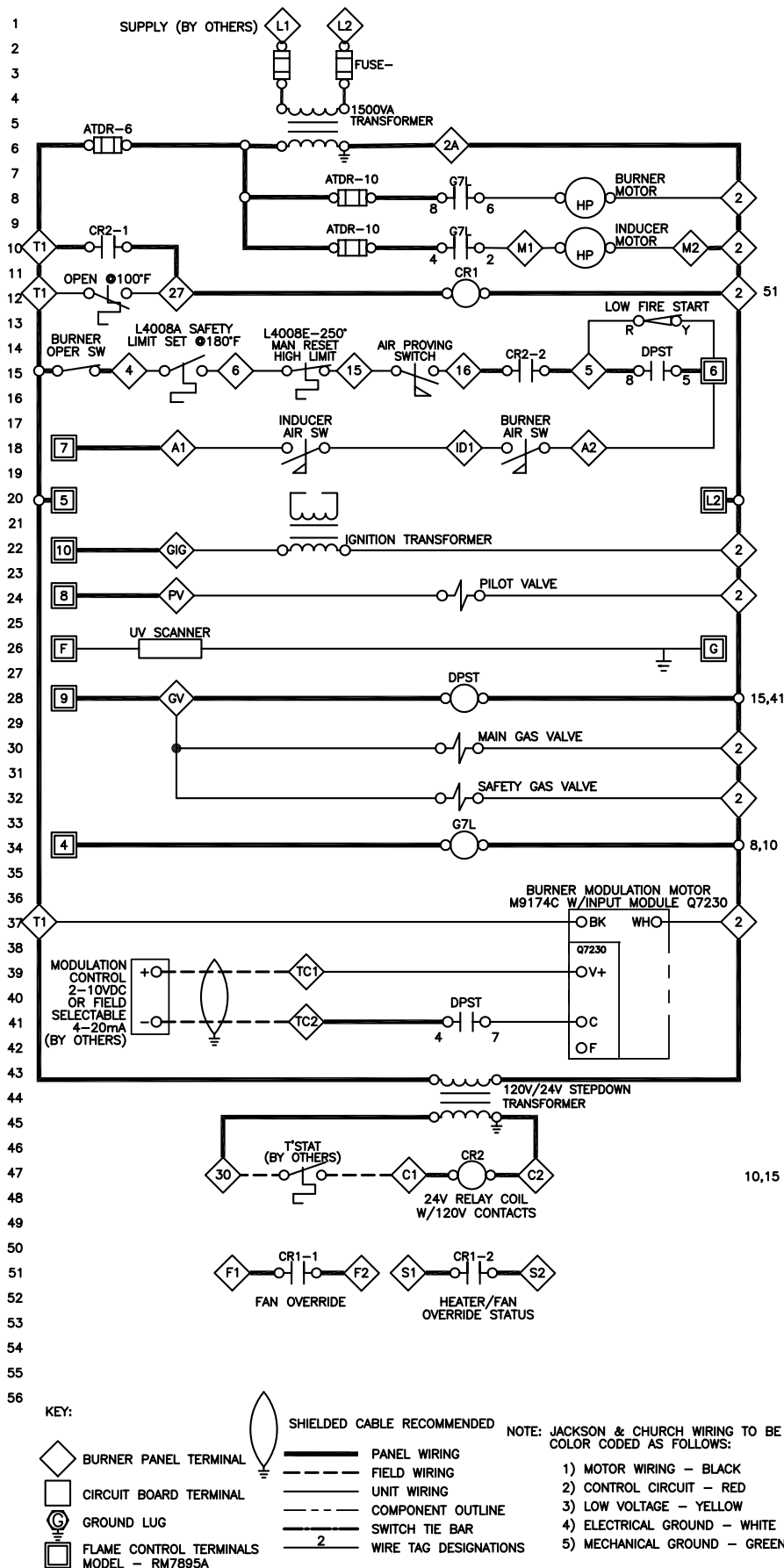


FIG. 6-10 - GAS HEAT, SINGLE PHASE, 1500VA TRANSFORMER, WIRING DIAGRAM

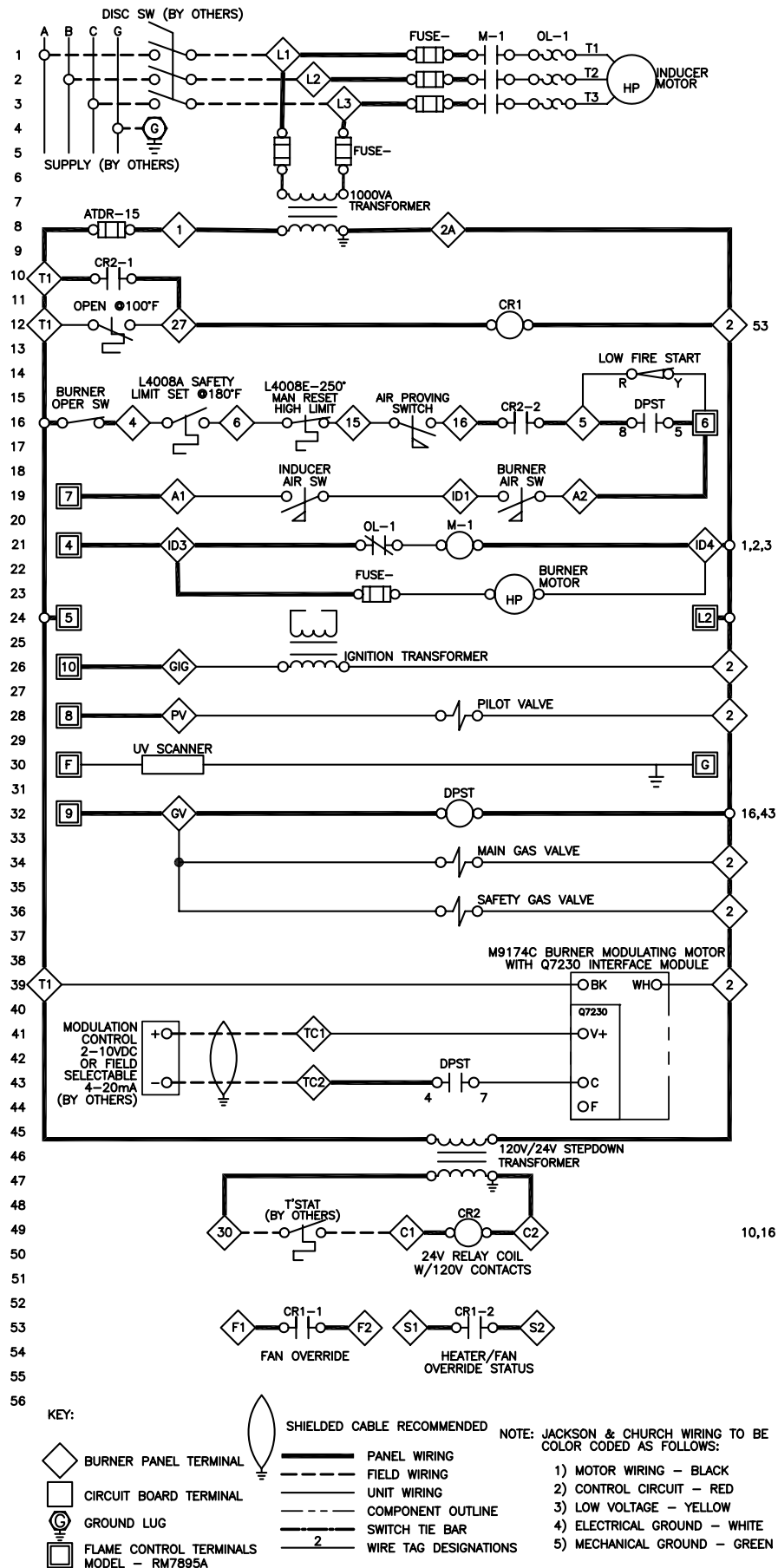
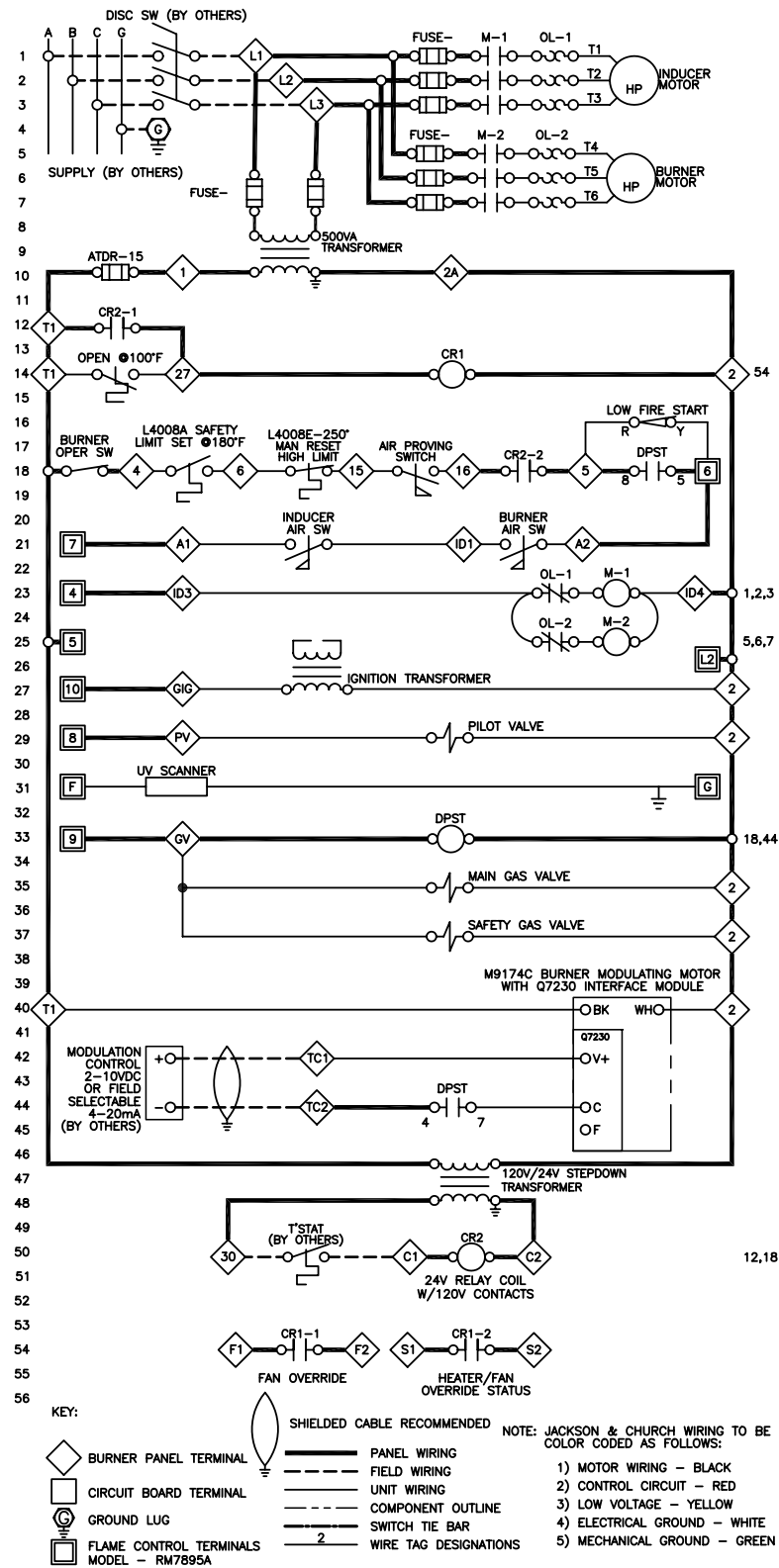


FIG. 6-11 – GAS HEAT, (1) THREE PHASE MOTOR, 1000VA TRANSFORMER, WIRING DIAGRAM



LD11691

FIG. 6-12 – GAS HEAT, (2) THREE PHASE MOTORS, 500VA TRANSFORMER, WIRING DIAGRAM





Form Number: 102.20-NOM1 (LS01)

307

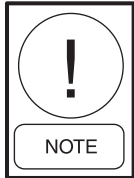
Supersedes: 102.20-NOM1 (LS01) (606)

LITERATURE SUPPLEMENT

File with: 102.20-NOM1 (105)

Subject: Pipe Chase Installation Instructions for Solution Air Handler

PIPE CHASE INSTALLATION



Pipe chase should be installed before piping is connected.

TOOLS REQUIRED

- Screw Gun
- Complete set of mechanics hand tools.

MATERIALS REQUIRED

- Shipped loose package containing 1/4"-14 x 1" Self-drilling Screws w/gasket (021-30530-052), Caulking (013-03317-040), Gasket, Neoprene, 2" x 3/16" (028-11880-010). *When unit purchased with Baserail:* Pipe Chase Baserail Covers (013-03317-010), 3/8"-16 x 1-1/2" Bolts (021-01499-000) and Lock Washers (021-01155-000).

PROCEDURE



Never use silicone caulk/sealant or caulk/sealant containing silicone in or on any air handling equipment. [Only exception is when provided (high temperature) with gas heat venting]



The top and bottom flanges are inside pipe chase. Separate cover angles are used on external vertical seams.



Before installing pipe chase, remove any self-drilling screws from the top & bottom raceway that may interfere with the installation of the pipe chase or trim angles.

1. Preparation

- Pinpoint the exact location to attach the pipe chase.
- Ensure enough space will remain to apply pipe fittings with insulation, inside the pipe chase.
- The pipe chase height should align with the unit height.

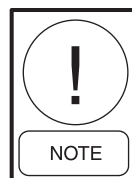
2. Apply Gaskets

- Apply provided 2" x 3/16" neoprene gasket to the underside of the air handler roof overhang (*see Fig. 1*).



FIG. 1 – INSTALL GASKET UNDER ROOF OVERHANG

- Apply gasket provided by curb vendor to top of curb.
- Apply 2" x 3/16" neoprene gasket to the pipe chase (vertical gaskets first, then horizontal gaskets). Keep the gasket aligned with the outside edges of the pipe chase housing (*see Fig. 2*).



*Horizontal gaskets must completely overlap vertical gaskets in all four corners (*see Fig. 2*).*



FIG. 2 – APPLY GASKET TO PIPE CHASE

3. Attach Pipe Chase

- Set the pipe chase on the pipe chase curb three inches away from the air handler.
- Tilt the top of the pipe chase toward the air handler. Work it under the air handler roof overhang, being careful not to damage the neoprene gaskets. Lift the pipe chase slightly to clear the gasket on the curb and swing the bottom into the air handler.
- If there is a baserail, attach the baserail of the pipe chase to the baserail of the air handler. Use 3/8" bolts & lock washers provided, placing bolts through the pipe chase baserail brackets into the threaded holes in the air handler baserail (*see Fig. 3*).
- Make sure the pipe chase is square and the door(s) close and open without rubbing or binding.
- Secure the pipe chase to the top and bottom raceways (heavy gage metal) of the air handler through the pre-punched holes of the inside top and bottom flanges of the pipe chase. Use self-drilling screws (*see Fig. 4*).

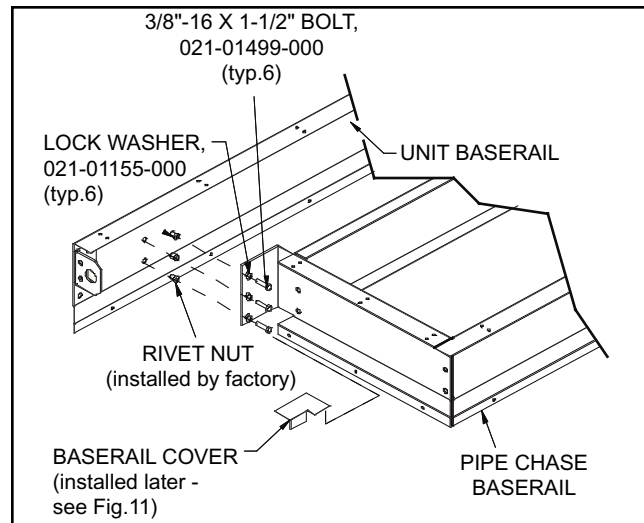


FIG. 3 – PIPE CHASE BASERAIL TO UNIT BASERAIL INSTALLATION (When Purchased)

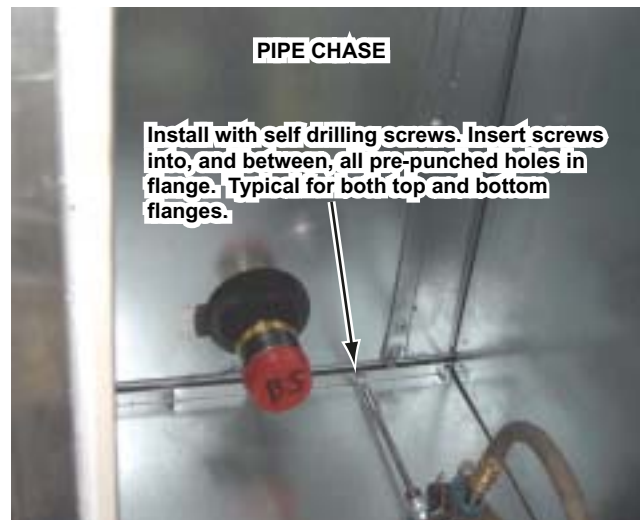
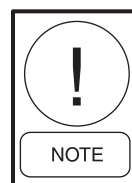


FIG. 4 – SCREW PIPE CHASE TO AIR HANDLER TOP AND BOTTOM INTERNAL FLANGES



Do not over tighten or strip self-drilling screws. Screws in top and bottom flanges go into heavier gauge metal than screws in cover angles.

- Check to be sure door closes and latches properly. If not, loosen self-drilling screws, re-align pipe chase and re-tighten screws. Occasionally the curb under the pipe chase may be uneven, depending on installation.
- ### 4. Seal Pipe Chase to Air Handler.
- Apply caulking to all exterior joints between pipe chase and air handler baserails (when purchased) (*see Fig. 5*).

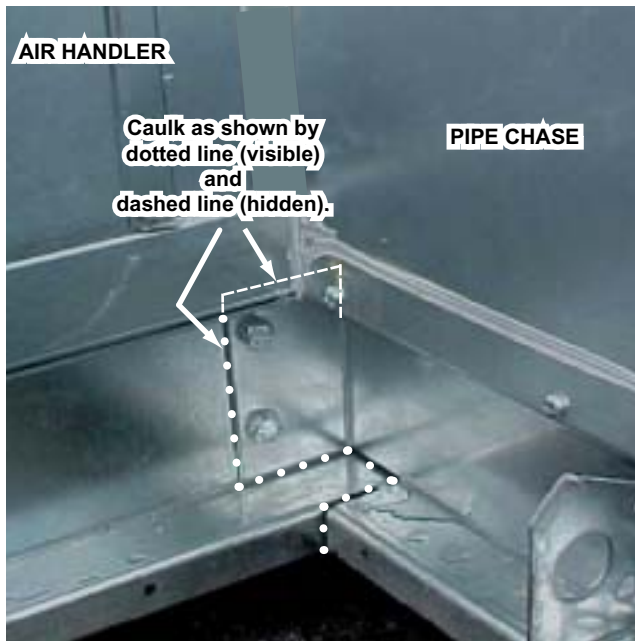


FIG. 5 – BASERAIL CAULK APPLICATION

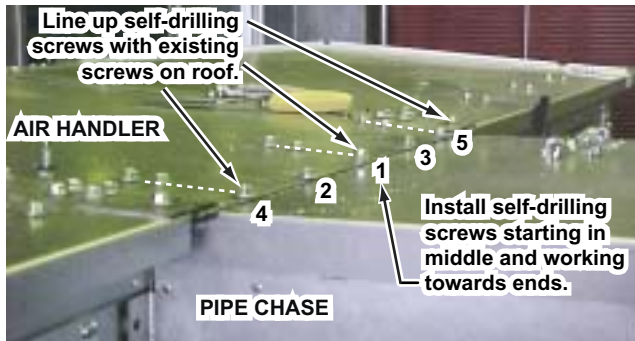


FIG. 6 – PIPE CHASE TO ROOF INSTALLATION

- Add a small bead of Sikaflex or Manus champagne caulking to the exterior vertical seam between the air handler and the pipe chase to insure complete seal. Pay special attention to the top & bottom corners, raceway & baserail engagements and under the roof overhang (see Fig.'s 5 & 7).
- Starting at the center, and working toward each end, run self-drilling screws down through the air handler overhang into the top of the pipe chase through the gasket. Use caution not to strip the 20-gage housing with the screws. Line up self-drilling screws with double row of screws on top of unit raceway, plus one spaced evenly between each (see Fig. 6) (No caulking required here.)

5. Install the Cover Angles
(See Fig. 8)

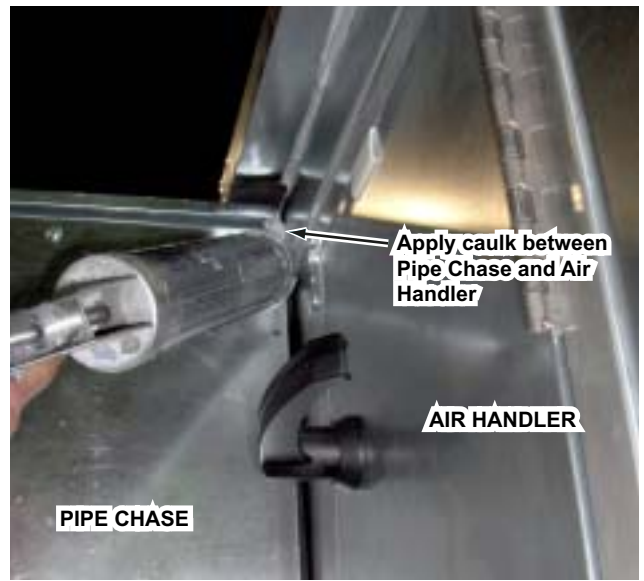
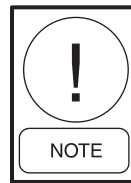


FIG. 7 – PIPE CHASE TO AIR HANDLER CAULK APPLICATION

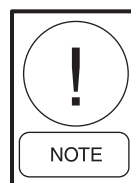


Cover angles must be installed before the caulk from step 4 dries.

- Apply 2" x 3/16" neoprene gasket to contact side of cover angle.
- Remove top and bottom self-drilling screws from pipe chase and set aside for later use.
- Place cover angles in vertical corners of pipe chase and unit wall.



FIG. 8 – INSTALL COVER ANGLE



Notch on cover angle must be on the air handler side (see Fig.9).

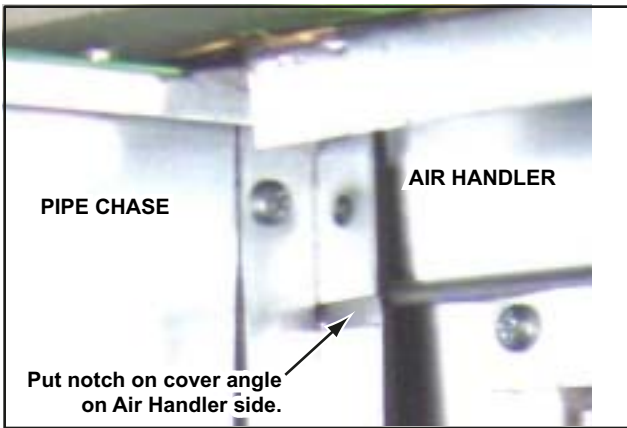


FIG. 9 – PROPER POSITIONING OF COVER ANGLE WITH NOTCH ON AIR HANDLER SIDE

- Attach the cover angle to the air handler and pipe chase panels. Install self drilling screws removed earlier to top and bottom holes on cover angle.
- Starting at the top and alternating between the air handler and pipe chase, continue installing self drilling screws until reaching the bottom. Use caution not to strip the 20-gage housing with the (see Fig.10).

6. Install the Baserail Covers

(See Fig. 11)

- Caulk perimeter of cover as shown.
- Apply cover to baserail seam between pipe chase and air handler (both sides) (no screws required).



All pipe chase floor penetrations must be flashed, sealed and insulated to prevent condensation entering building.

IF ANY QUESTIONS, CONTACT (800) 838-7219, EXTENSION 7448.

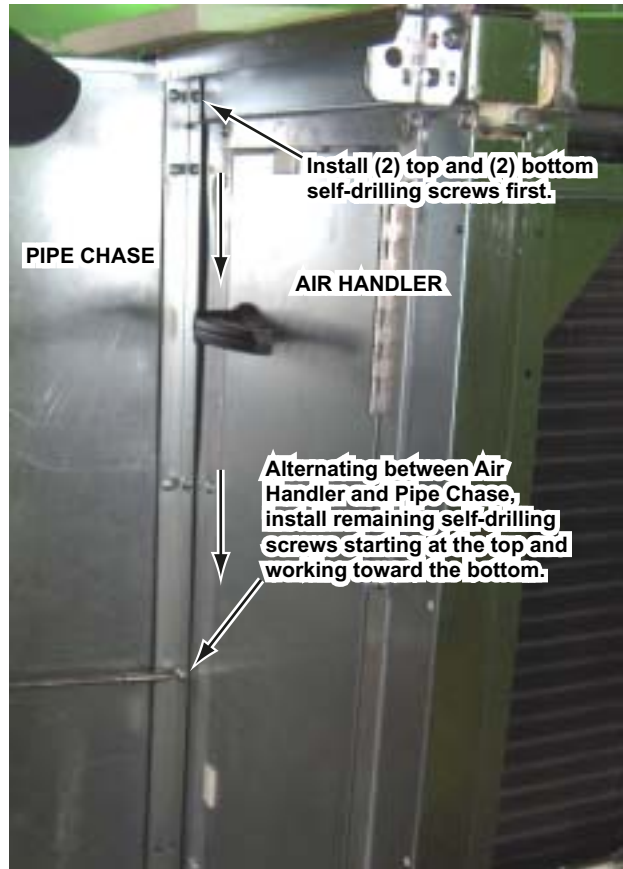


FIG. 10 – PROPER PATTERN FOR INSTALLING SELF-DRILLING SCREWS TO COVER ANGLE

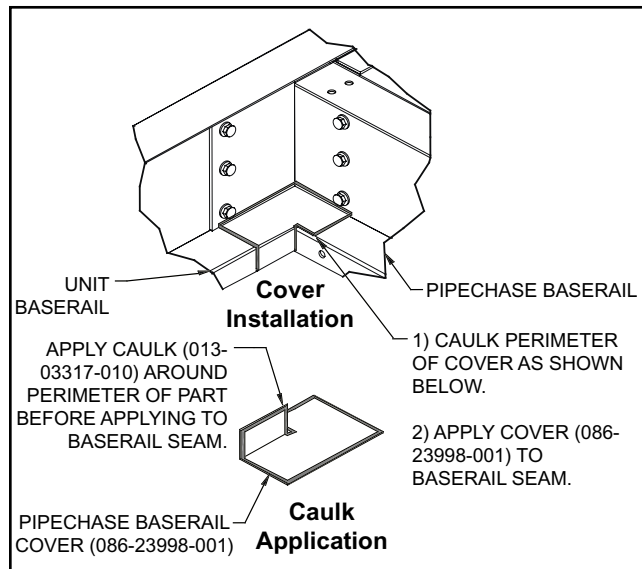


FIG. 11 – BASERAIL COVER APPLICATION





BY JOHNSON CONTROLS

LITERATURE SUPPLEMENT

Form Number: 102.20-NOM1 (LS02)

1108

Supersedes: 102.20-NOM1 (LS02) (605)

File with: 102.20-NOM1 (105)

Subject: Ship Loose Parts for Solution Air Handler

Look for label "Installation Instructions and Ship Loose Items Inside". This label is normally located on the access door of the first fan section in the air stream. Only the parts listed in this section which are required for your unit are included.

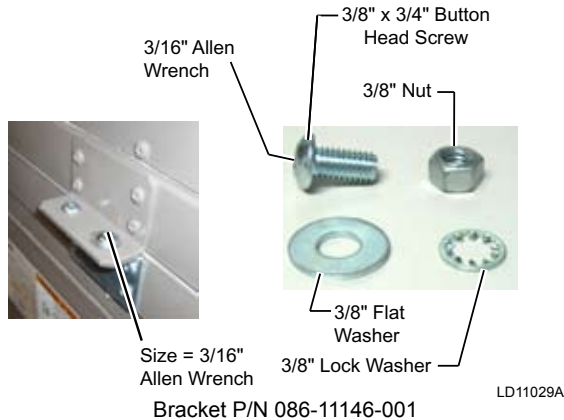
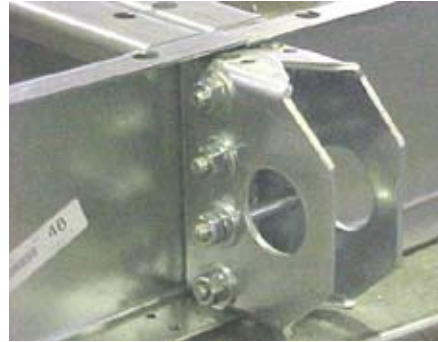


FIG. 1 – SECOND TIER TIE-DOWN FASTENER PACK P/N 386-03419-000 (4 each per pack)



Baserail Lifting Lugs Assembled



Raceway Lifting Lug (at shipping split)

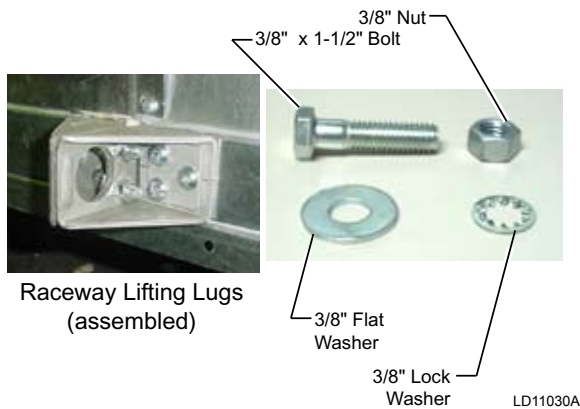


FIG. 2 – BOTTOM RACEWAY SHIPPING SPLIT FASTENER PACK P/N 386-03418-000 (4 each per pack)

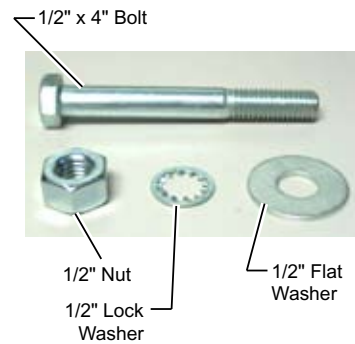
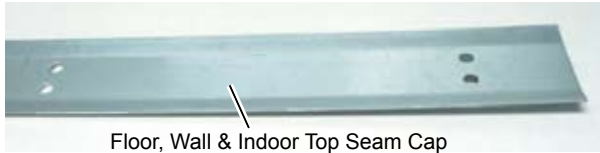


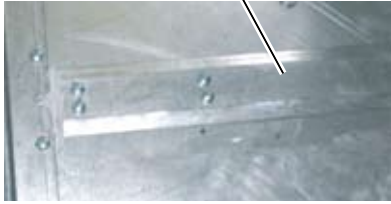
FIG. 3 – BASERAIL SHIPPING SPLIT FASTENER PACK P/N 386-03417-000 (4 each per pack)



FIG. 4 – TOP RACEWAY SPLIT FASTENER PACK P/N 386-04747-000 (2 each per pack)

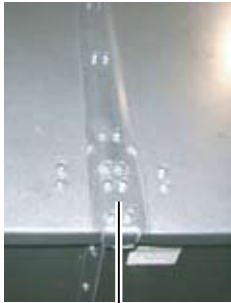


Floor, Wall & Indoor Top Seam Cap



SEAM CAP

- 1/4" x 2" Neoprene Gasket, P/N 028-15954-010
- 1/4"-14 x 1" Phillips Pan Head Tek Screw, P/N 021-19560-000
- 1/4"-14 x 1" Hex Head w/ Washer & Gasket Tek Screw P/N 021-30530-052 for Outdoor Wall.



Roof Seam Cap (Outdoor)



ROOF SEAM CAP

- 1/4" x 2" Neoprene Gasket, P/N 028-15954-010
- 1/4"-14 x 1" Hex Head w/ Washer & Gasket Tek Screw P/N 021-30530-052 for Outdoor Roof.

Apply 2" Gasket & Caulk



Apply 2" Gasket & Caulk

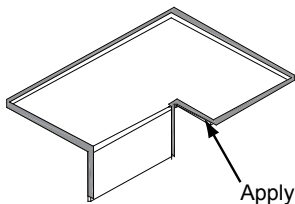
PIPE CHASE

- 1/4" x 2" Neoprene Gasket, P/N 028-15954-010
- 1/4"-14 x 1" Hex Head w/ Washer & Gasket Tek Screw P/N 021-30530-052



PIPE CHASE TRIM ANGLE

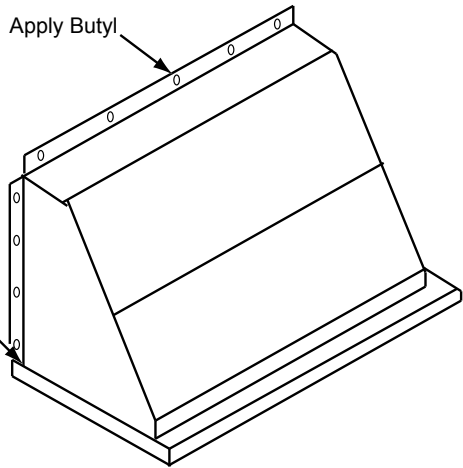
- 1/4"-14 x 1" Hex Head w/ Washer & Gasket Tek Screw P/N 021-30530-052
- 1/4" x 2" Neoprene Gasket, P/N 028-15954-010



PIPE CHASE BASERAIL COVER
P/N 086-23998-001

Apply Butyl

Apply Caulk

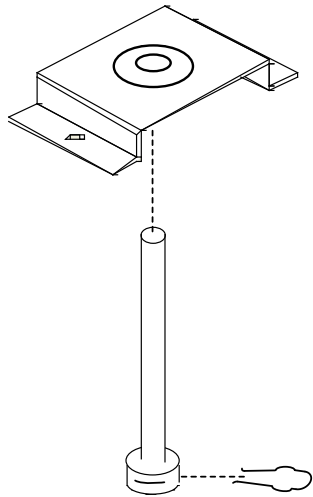


HOOD

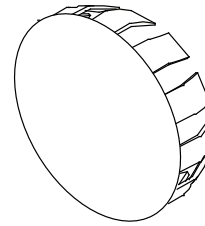
- 1/4"-14 x 1" Hex Head w/ Washer & Gasket Tek Screw
- 3/16" x 3/4" Butyl Tape

LD13770

FIG. 5 – PIPE CHASE, HOODS & SEAM CAPS



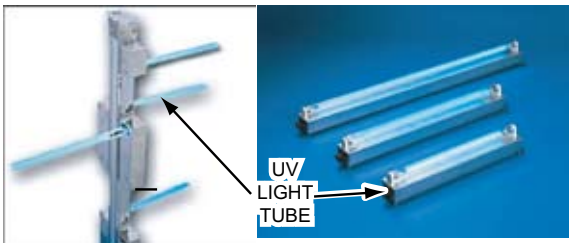
DAMPER SHAFT EXTENSION KIT
P/N 026-33715-002



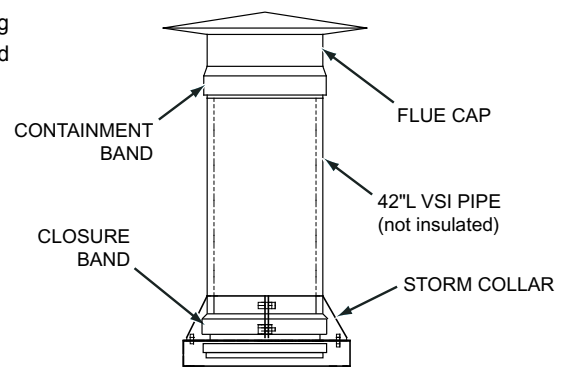
CORNER CONNECTOR HOLE PLUG
P/N 021-19568-000

HUMIDIFIERS

Optional Steam humidifiers, when selected are provided with dispersion equipment factory mounted inside the air handling unit. The steam injection or generating equipment, metering devices & sundries are shipped loose.



UV LIGHT TUBES to be installed by contractor.



GAS FURNACE FUEL VENTING PARTS



DO NOT touch UV Lamps (tubes) with bare hands or leather gloves as oils will damage the tubes. Use clean cotton rags, clean jersey or latex gloves to handle the lamps (tubes).

LD13788

FIG. 6 – MISCELLANEOUS PARTS FOR OPTIONS



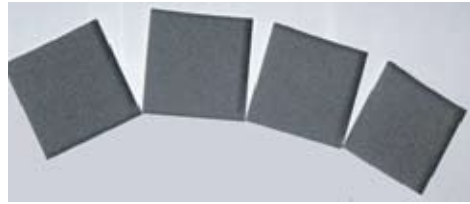
POLYURETHANE CAULK
P/N 013-02966-011



Never use silicone caulk/sealant or caulk/sealant containing silicone in or on any air handling equipment. [Only exception is when provided (high temperature) with gas heat venting]



12 OZ. TOUCH-UP SPRAY
P/N 013-03322-000



1/4" X 3-1/2" x 3-1/2" SHIPPING SPLIT
CORNER GASKET
P/N 028-11883-010
(Outdoor Only)



1/4" X 2" X 25' NEOPRENE GASKET
P/N 028-15954-010



3/16" X 3/4" X 40' BUTYL TAPE
P/N 013E-03327-010



1/4" X 3/4" X 35' NEOPRENE
GRAY GASKET
P/N 028-11873-010



1/4"-14 X 1"
PHILLIPS PAN HEAD
SELF DRILLING SCREW
P/N 021-19560-000



SPARE FAN BELT
(Attached to Fan)



1/4"-14 X 1"
HEX HEAD
SELF DRILLING SCREW
W/ EDPM WASHER
P/N 021-30530-052

Id13771

FIG. 7 – HARDWARE, GASKETING, CAULK, PAINT AND TAPE





Form No.: 102.20-NOM1 (LS03)

506

Supersedes: None

LITERATURE SUPPLEMENT

File with: 102.20-NOM1 (105)

Subject: Installation of Multizone (MZ) Dampers

INSTALLATION OF MULTIZONE (MZ) DAMPERS

See Figure 1



SHIPPED LOOSE DAMPERS. If the MZ segment has a shipping split, a rear discharge (end of unit), and a multizone damper, then the multizone damper will be shipped loose.



Distortion will result in unreliable blade operation.

DAMPER INSTALLATION

1. After the unit top tier is assembled to the unit bottom tier and sealed, install MZ damper assembly. The assembly includes both hot deck and cold deck damper banks, already connected at each blade.

2. Remove 16 gauge shipping plate from air entering side ONLY. Plate is located between hot and cold decks.
3. Apply gasket provided (P/N 028-11778-010, Neoprene, 1-1/4" W x 1/4" Thk) to the mounting flanges of the damper assembly.
4. Center the damper assembly over the discharge openings of the hot deck (top) and cold deck (bottom).

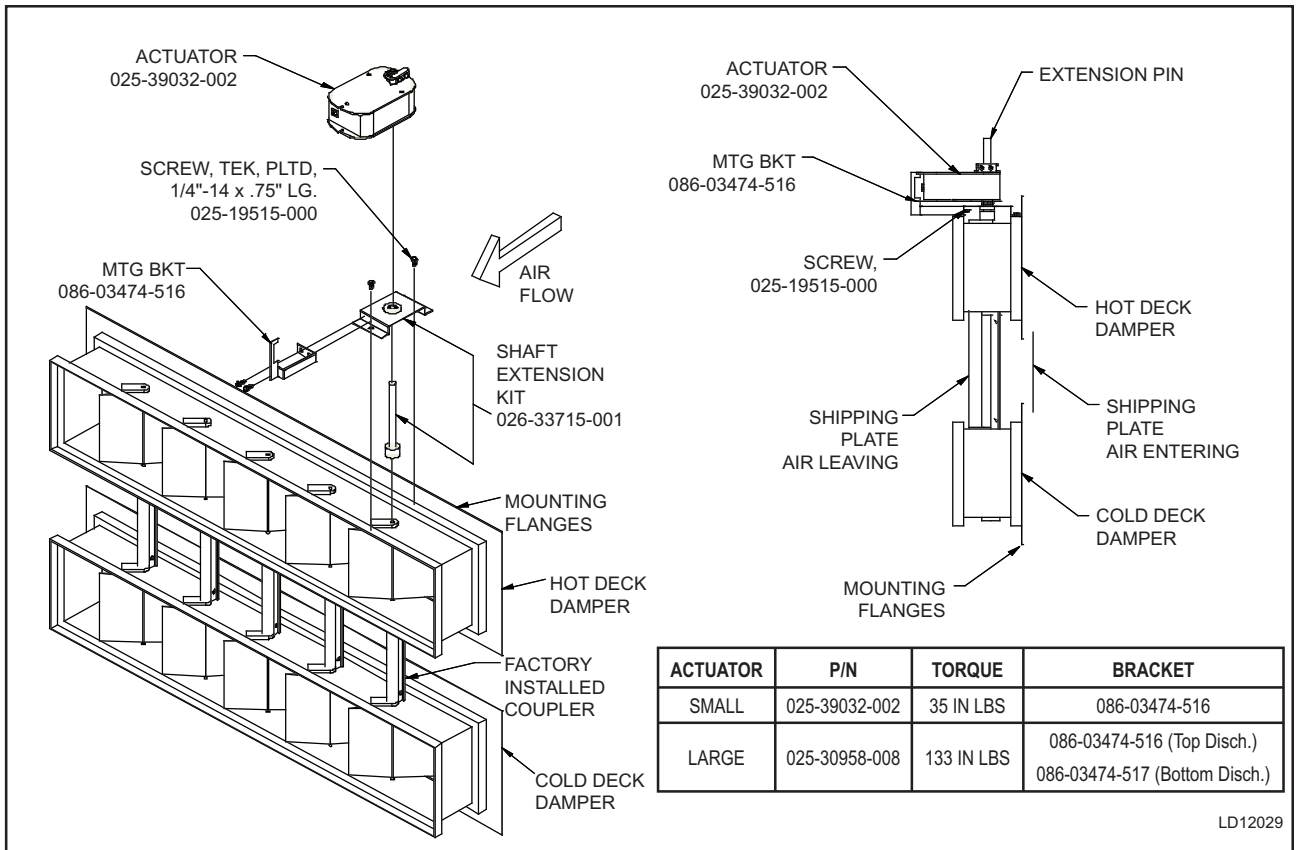


FIG. 1 – MZ DAMPER/ACTUATOR ASSEMBLY

5. Attach the damper assembly to the unit using screws provided (P/N 021-19515-000 - screw, hex, self-drilling, 1/4"-14 x 3/4"), through the outer perimeter mounting flange.
6. Remove 16 gauge shipping plate from air leaving side.
7. Install screws through mounting flanges found between hot and cold decks.

ACTUATOR INSTALLATION - FIELD SUPPLIED

When actuators are field supplied on multizone dampers, the following information is intended to aid in sizing and selection:

- Torque required is 7 inch pounds per square foot of damper area up to 2500 FPM velocity.
- Damper blades are 6" wide and vary in height.
- Calculate the torque by number and size of blades in each individual zone. Remember there are hot deck blades directly connected to cold deck blades.
- Blades per zone are to be determined by system CFM and static pressure requirements for each zone by the Engineer's construction documents.


- The blade linkage (flat rods) connecting all blades of each deck are to be cut at the appropriate places to divide the decks into correct size zones. These blade linkage rods are mounted externally on each deck.
- Shaft extensions, clips, hat channels, actuators and actuator mounting brackets are to be supplied by the contractor. York P/N's available upon request.
- On rear mount (discharge through end of unit), always mount the actuators on the top of the upper (hot) deck.
- Do not allow duct insulation to restrict damper blades or external linkage.
- Direct coupled actuators are recommended.
- Duct connections are to be made at the zone dividers without damper blade restriction.

MAINTENANCE

Follow recommendation in IOM (*see Section 4 of 102.20-NOM1 (105) "Economizer Segment (Dampers)"*).



A JOHNSON CONTROLS COMPANY

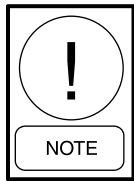
| | | |
|---|------------------------------------|-----|
|  BY JOHNSON CONTROLS | Form No.: 102.20-NOM1 (LS04) | 109 |
| | Supersedes: 102.20-NOM1 (LS04) 208 | |
| LITERATURE SUPPLEMENT | File with: 102.20-NOM1 (105) | |
| Subject: Indirect Fired Gas Heat Start Up - Eclipse Gas Burner Start Up 10:1 - 25:1 Turndown & Powerflame Gas Burner Start Up 3:1 - 10:1 Turndown | | |



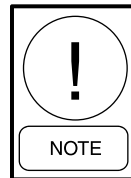
For your safety and satisfaction, this product requires check, test and start-up adjustment by a qualified HVAC technician. Do not use for temporary heat prior to start-up.



Review burner control literature, including wiring, piping, cut sheets and drawings before attempting to start this unit.



All factory test start up burner specifications are located on a laminated "Factory Specification Sheet" located on the inside of the control panel door".



Your gas burner has been carefully inspected and tested at the factory; however, different conditions at the jobsite, including controls that have been added at time of installation, require careful testing and final adjustment for satisfactory operation. The Burner Test Report / Factory Specification Sheet in each unit shows the general data recorded during the operation and safety tests at the factory. This data should be used as a general guide; with final data recorded on the start-up form. Do not exceed 550°F flue temperature at the ID fan inlet. Do not exceed 200°F supply air temperature.

INTRODUCTION

This guideline describes the basic steps a technician would take in starting an Indirect Fired gas heat system on a YORK Solution Air Handler for the first time.

Each gas burner has been test run and inspected at the factory. Adjustments to component settings are typically not required. However, measurements of system parameters should be taken and compared to the measurements recorded on the "Burner Test Report" to ensure safe and reliable operation. The "Burner Test Report" is laminated to the inside of the burner control door.

IDENTIFY THE UNIT TYPE

Two types of Indirect Fired gas burners are used on YORK Solution Air Handlers: The Powerflame series and the Eclipse series. The Powerflame series offers a turndown (modulating ratio) of 3:1 or 10:1. The Powerflame is easily identifiable by the motorized gas valve with external linkage connecting the air dampers on the burner air inlet.

The Eclipse series uses an air/gas ratio regulator with no external linkage, and has a turndown range of 10:1 to 25:1 (sometimes greater). A visible external plastic tube is used to transmit gas pressure from the burner to the regulator. No external linkage is used.

Both burners utilize a combustion air blower. YORK Solution Air Handlers also use an exhaust blower, called an induced draft (ID) blower. This exhaust blower keeps the combustion chamber at a slight negative pressure. Verification of this negative pressure and other system parameters is part of a proper start up procedure.

PRELIMINARY COORDINATION

Contact contractor/customer who requested start-up.

- Verify air handler has had proper start-up.
- Ensure air handler and system is capable of design airflow for gas heat start-up.
- Ensure reliable power is available.
- Verify gas lines are purged of air to equipment valve.
- Verify controls are complete.
- Verify flue (stack) is correctly installed if parts were shipped loose (*see Fig's 3-21 and 3-22*).

TOOLS RECOMMENDED

- **Electrical Multimeter w/ Amprobe**
- **Heating Unit Installation and Operation Instruction.** - One is provided with every heating unit for technical information and troubleshooting.
- **Magnehelic Gauge 0" To .25" WC, Dwyer Series 2000 or Model 1227 Dual Range Manometer.** - For checking pressure over fire (draft).
- **Control Signal Generator, 0 to 20 mA (Altek-234 or 334A)** - For 2 to 10 VDC signal add 500 ohms in series with signal generator.
- **Magnehelic Gauge 0" to 15" WC and 0 to 3 lbs. (Dwyer series-2000) or Monometer (Dwyer- 1227) Dual Range Monometer.** - For checking supply gas pressure and manifold gas pressure or pilot gas pressure.
- **Honeywell - S7800A Test Module** - For use on (Honeywell-7800) Series Relay Module. (Available through Airside Parts - 800-545-7814, Ext.12).
- **Flue Gas Analyzer (CO₂ and O₂)**
- **Stack Thermometer (0°F - 1000°F approx.)**

AIR HANDLER PRE START CHECKS

- Verify air handler has had proper start up and airflow is at design maximum for heating cycle (*refer to air balance report*).
- Set bypass damper if provided in air handler.
- Airflow proving switch for main supply fan installed and operational.
- Check with Control Technician: two-minute post-purge programmed in air handler controller. Upon call for air handler unit stop, burner cycles off then air handler fan cycles off two minutes later.

BURNER PRE START CHECKS

1. Open fuse disconnects before working on burner (*see Fig. 3-13*).



FIG. 3-13 – OPEN FUSE DISCONNECTS

2. Check all wire terminations for tightness.
3. Check that the incoming voltage(s) are correct. Compare measured voltages to burner motor and ID motor nameplates and the "Burner Test Report". Reset fuse disconnects.
4. Check for correct rotation of 3 phase burner motor and ID motor.
5. Verify that contractor has purged new gas lines of air up to manual valve on gas train.
6. Valves which have been closed for shipping must be opened accordingly. Check that all manual valves operate without leaks.

7. The flue (stack) damper is located at the discharge of the ID blower and closed for shipping. Release the locking mechanism and set the damper to match the position indicated by the scribed markings. Lock in place (see Fig. 3-14).

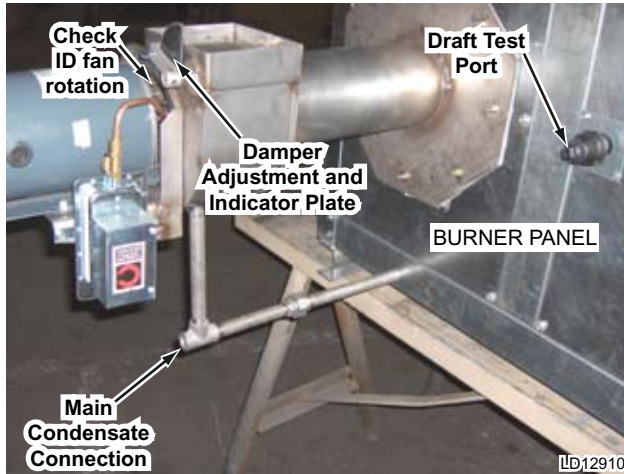


FIG. 3-14 – SET ID FAN DAMPER

8. Inspect condensate drain trap to see that it is large enough, as described in this guideline (see Fig. 3-20).
9. Measure the gas supply pressure coming into the gas train (see Fig. 3-15). Gas pressure can be greater than shown on the “Burner Test Report”, but it must be between the min/max values listed in Table 3-2.

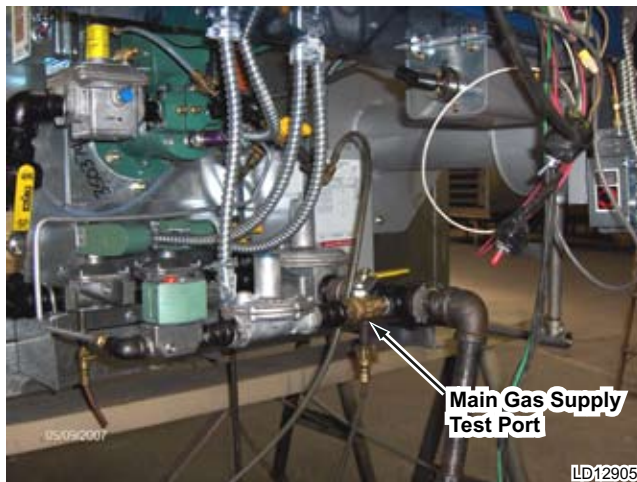
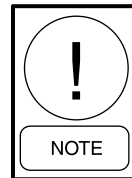
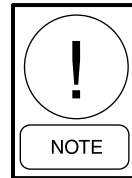


FIG. 3-15 – CHECK MAIN GAS SUPPLY PRESSURE

10. Visually check that the high temperature safety limit is set for a 200-230°F range. The limit switch is typically mounted behind the burner control panel.
11. Connect a 0-15" gas pressure gauge or other suitable instrument to the gas manifold port. The gas pressure will be measured when running (refer to step 4 of Burner Start-up Procedure).



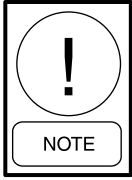
On Powerflame burners this test port is downstream of the main regulator, typically on a standard tee fitting in the main gas line.



On Eclipse burners, this test port is located on the backside of the burner, just below the spark igniter. A small valve is provided at this test port.

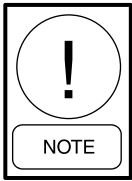
12. Connect a manometer or other suitable device to the Heat Exchanger Draft Port located on the side of the unit near the burner. The expected draft should read slightly negative – about -.03" WC. The draft port is typically made of 3/4" steel pipe and may be plugged. Remove plug and add a small stop valve and a nipple for a rubber tube (see Fig. 3-14 & 3-16).
13. Install the Honeywell S7800 Test Module (display), if available.
14. Connect signal generator (0-20mA) to terminals in place of modulation control signal (for 2-10 VDC signal add a 500 Ω resistor in series). See Fig. 3-23.
15. Visually check that the flue (stack) is secure and connected properly. Typical connections are shown at the end of this guideline (see Fig. 's 3-21 & 3-22).
16. Burner panel off/on switch should be “off”.

System is now ready for start up.

BURNER START-UP PROCEDURE

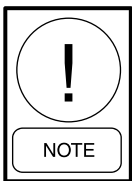
Prior to starting burner, technician must verify incoming gas pressure. A minimum pressure is listed on the “Burner Test Report”. The maximum pressure is listed in Table 3-2.

1. Open manual gas valves on gas supply and pilot line.
2. Initiate a call for heat or use jumper to create call for heat (see Fig. 3-23 for typical wiring diagram).
3. Turn burner panel off-on switch to on.



Once there is a call for heat, a 30 second pre-purge period is initiated to remove any gases from the heat exchanger. The burner will then go through a second purge before ignition.

4. The burner will automatically go to Low Fire at start up. After proof of Low Fire, the burner will modulate up to High Fire. This may take 15 seconds for a Powerflame burner and 90 to 180 seconds for the Eclipse burner. After the burner operates at High Fire use the manometer connected to the Heat Exchanger Draft Port (see Fig. 3-16), observe the reading. A negative pressure of about $-.03$ " WC is expected for draft overfire. Readings may differ slightly from those shown on the “Burner Test Report”.



For valid readings, before making any adjustments, allow the burner to fire at least 20 minutes to allow the heat exchanger to come up to operating temperature.

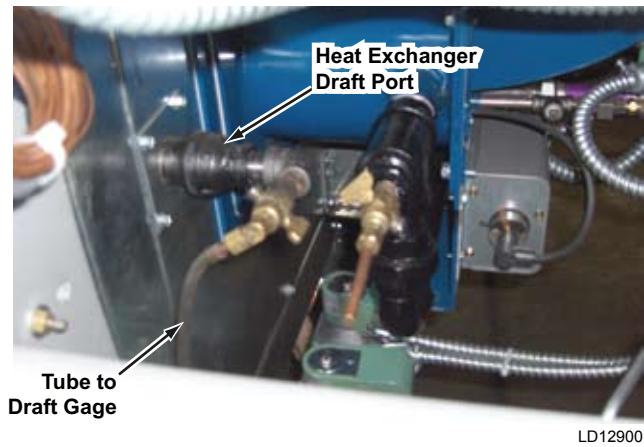


FIG. 3-16 – DRAFT OVER FIRE TEST PORT

5. Observe the gas manifold pressure and compare to data on the “Burner Test Report” under both High Fire and Low Fire conditions.
6. Check the flue (stack) combustion temperature at the ID Blower Housing Test Port. Make sure the test probe is inserted half way into the ID Inlet Tube (see Fig. 3-17). Compare results to the “Burner Test Report”.

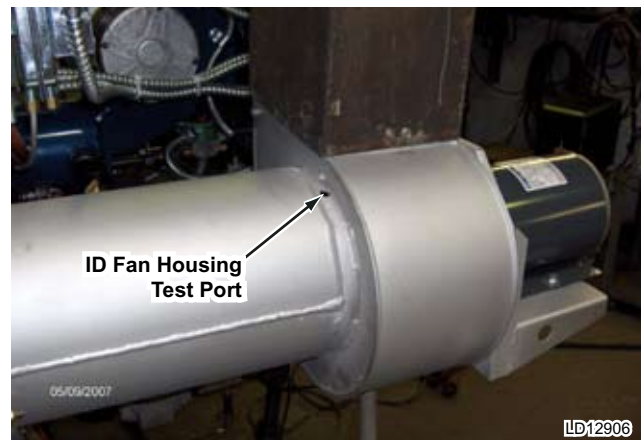
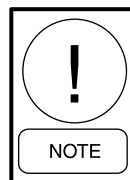


FIG. 3-17 – FLUE (STACK) COMBUSTION TEMPERATURE AND EFFICIENCY TEST PORT



Ignition transformer is intermittent. Pilot continues to burn after ignition transformer is de-energized.

7. Using the signal generator, cycle the burner to check capacity modulation. Observe valve/damper actuator operation.

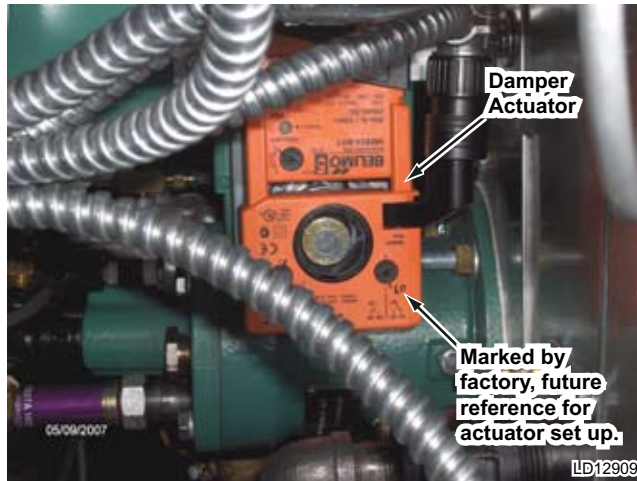
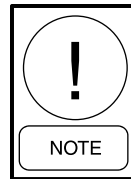


FIG. 3-18 – DAMPER ACTUATOR

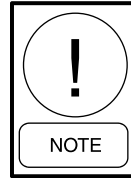
8. Using the standard operating controls, cycle the burner several times to assure proper sequencing of start-up, firing, and capacity modulation, plus operation of all safety and monitoring controls.
9. Test 180°F. high temp. safety by running burner with airflow off or diverted. Burner will shut down at 180°F. Turn air handler on as quickly as possible to remove heat from the heat exchanger.
10. Burner efficiency testing should be done last. The burner should be running at High Fire rate for 30 minutes before efficiency testing is done.
11. Efficiency at High Fire is pre-determined, but may be checked by flue gas analysis at the entrance to the ID Blower Housing Test Port. At High Fire CO₂ should be between 8-1/2 and 10 %; O₂ should be between 7-1/2 and 4%. With these ranges, efficiency is 80% plus or minus 2% (see Fig. 3-17).
12. Contact contractor, facilities manager or customer to inform successful start-up has been completed.



In the unlikely event that adjustment is required; it is done at High Fire and must NOT retard Low Fire light-off.



Do not change set up of factory preset air inlet dampers on Power Flame burner.



Any questions should be directed to your local Service office or Johnson Controls Product Tech Support, before contacting the burner manufacturer.



FIG. 3-19 – CONDENSATE DRAIN

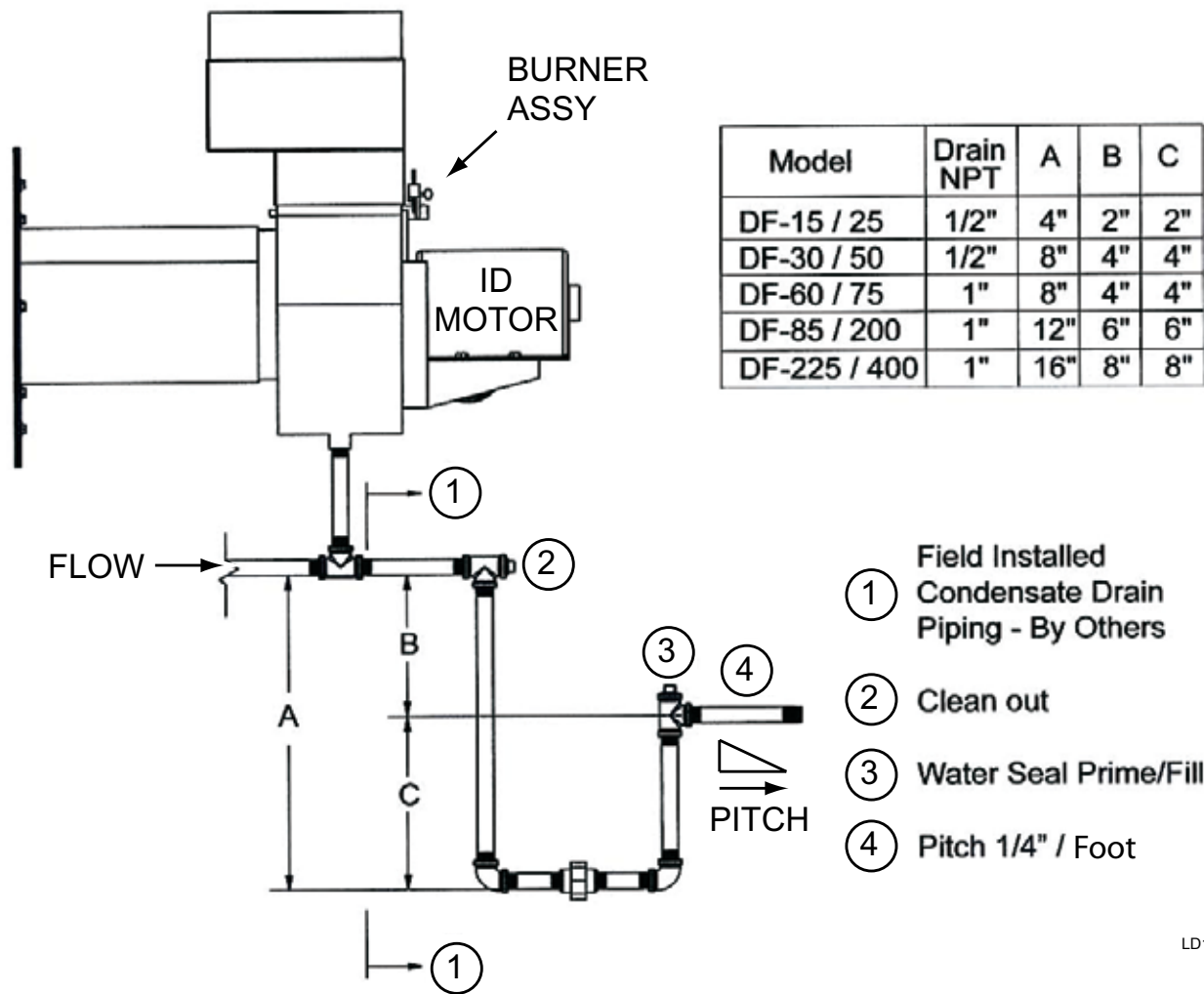
CONDENSATE DRAIN ARRANGEMENT

The YORK Solution Indirect Fired gas heat exchanger has the potential to create highly acidic condensation, particularly during extended operation at low capacity or low firing rate conditions. To insure proper drainage the following guidelines should be followed (See Fig. 3-20).



When constructing the condensate trap for the heat exchanger drainage system, make sure the trap is tall enough to handle the Total Static Pressure of the ID Blower at Low Fire times 2.

Example: TSP is 6" at Low Fire - construct trap 12" tall (See Table in Fig. 3-20).



LD12912

FIG. 3-20 – GAS FURNACE CONDENSATE DRAIN TRAP



Failure to follow these guidelines may cause excessive condensation build up resulting in water damage to the facility and/or a cracked heat exchanger.

1. Observe local jurisdiction codes for gravity condensate drainage requirements.
2. Be sure the air handler is installed at an elevation that enables proper condensate drainage and trapping dimensions as provided in Fig. 3-20. Minimum trap dimensions MUST be accommodated.
3. Condensate drain line size must be the full line size of the heat exchanger drain connection.
4. Drain lines, fittings and supports should conform to local codes and be suitable for the application.
5. Condensate drain and trap discharge should be pitched away from the equipment at a slope of 1/4" per linear foot or as local code dictates.
6. For outdoor or unconditioned space installations local climate may dictate the need to heat trace and/or insulate the exposed drain lines and trap. Frozen drain lines and/or trap will cause build up of condensate inside the heat exchanger resulting in leakage and damage to the air handler and possibly to the facility.
7. Provide unions in drain lines to allow removal of trap for periodic cleaning of drain lines as well as the trap. When the burner is operated at low capacity for extended periods, more condensate is generated and with it deposits of solids in the condensate drainage system.
8. Provide the ability to prime the trap. During initial and seasonal start up, trap inspection and priming is required. Condensate in the trap will evaporate during long periods of non-use.

GAS HEAT SEGMENT MODEL NUMBER NOMENCLATURE

| B REV LEVEL | 100 DF SIZE/ CAPACITY MBH | U CODE COMPLIANCE | 3 BURNER TDR | L UNIT HAND YORK DESIGNATION | G ID FAN HOUSING | G UNIT VOLTAGE | A CONTROL VOLTAGE (T*STAT VOLTAGE) | A BURNER MOD CONTROL |
|-------------------|------------------------------------|-------------------------|--------------------|---------------------------------------|------------------------|----------------------|---|-------------------------------|
| A | 15 | A | 3 | L | G | A | A | A |
| B | 20 | U | 10 | R | S | B | B | B |
| C | 25 | F | 25 | R | S | C | 120 | C |
| | 30 | R | | | | | 24 | |
| | 35 | | | | | | | |
| | 40 | | | | | | | |
| | 45 | | | | | | | |
| | 50 | | | | | | | |
| | 60 | | | | | | | |
| | 75 | | | | | | | |
| | 85 | | | | | | | |
| | 100 | | | | | | | |
| | 125 | | | | | | | |
| | 150 | | | | | | | |
| | 175 | | | | | | | |
| | 200 | | | | | | | |
| | 225 | | | | | | | |
| | 250 | | | | | | | |
| | 275 | | | | | | | |
| | 300 | | | | | | | |
| | 325 | | | | | | | |
| | 350 | | | | | | | |
| | 375 | | | | | | | |
| | 400 | | | | | | | |

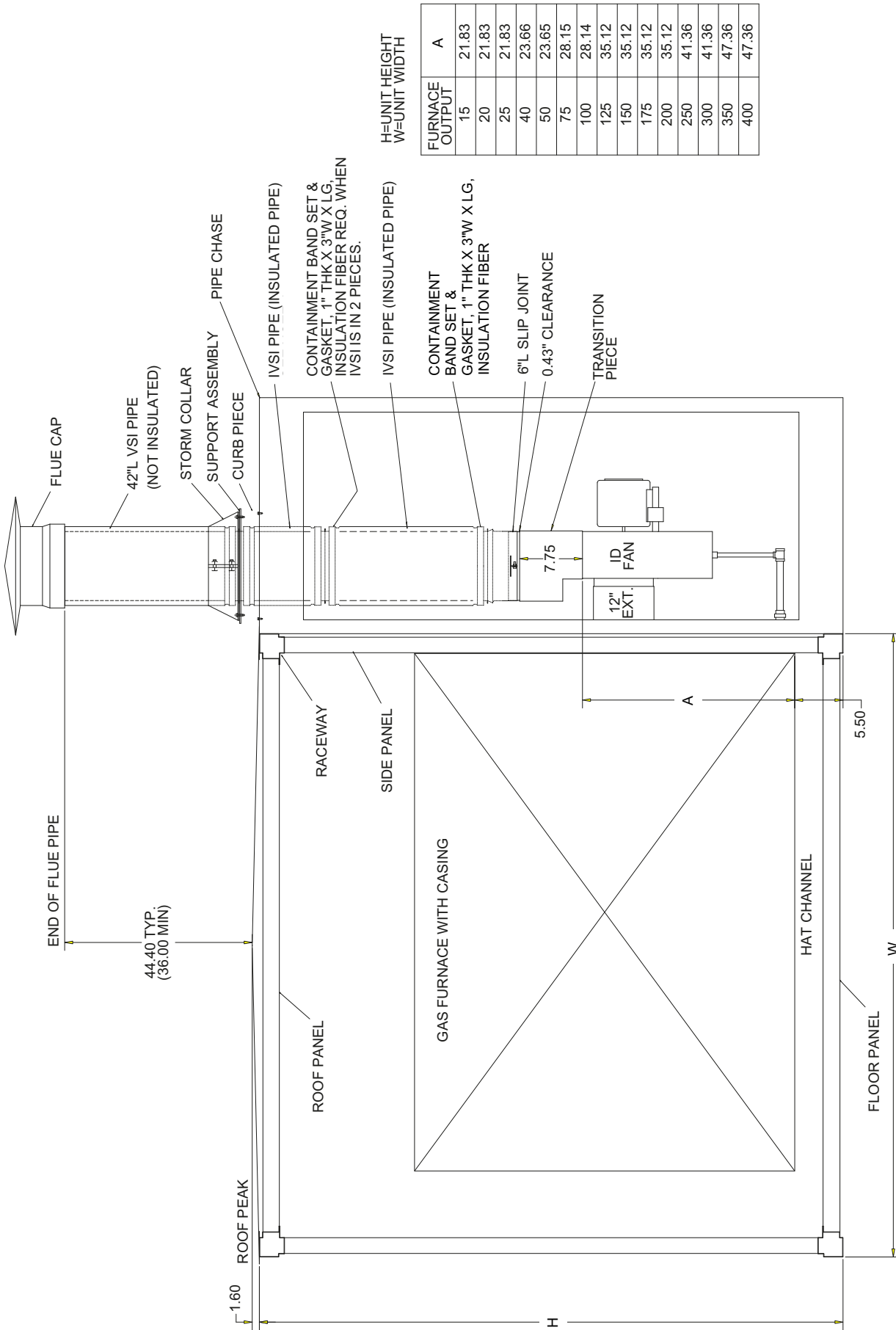
GAS { GAS LP = 2,500 BTU/ CU FT.
NATURAL = 1,000 BTU/ CU FT.
Output is approx. 80% of input BTU's

| NOMENCLATURE | | MAXIMUM ALLOW INLET PRESSURE | | | | | | | | | | | | | | MINIMUM INLET PRESSURE TO FIRE | | | | | | | | | | | | | | | | | | | | | | |
|--------------|-----------------------|---------------------------------|--------|--------|---------|-----------|---------|---------|--------------------|-----------|---------|---------|----------|----------|--------|--------------------------------|---------|-----------|---------|---------|----------|-----------|---------------|---------|----------|----------|--------|--------|---------|-----------|---------|---------|----------|-----------|---------|---------|----------|--|
| | | GAS BURNER PIPING/GAS BURNER TD | | | | | | | GAS BURNER PIPING/ | | | | | | | GAS BURNER TD | | | | | | | GAS BURNER TD | | | | | | | | | | | | | | | |
| | | A03 | U03 | F03 | R03 | A10 | U10 | F10 | R10 | A25 | U25 | F25 | R25 | A03 | U03 | F03 | R03 | A10 | U10 | F10 | R10 | A25 | U25 | F25 | R25 | A03 | U03 | F03 | R03 | A10 | U10 | F10 | R10 | A25 | U25 | F25 | R25 | |
| FEATURE | GASBTUS | ANSI 3 | UL 3 | FM 3 | IRI 3 | ANSI 10 | UL 10 | FM 10 | IRI 10 | ANSI 25 | UL 25 | FM 25 | IRI 25 | ANSI 3 | UL 3 | FM 3 | IRI 3 | ANSI 10 | UL 10 | FM 10 | IRI 10 | ANSI 25 | UL 25 | FM 25 | IRI 25 | ANSI 3 | UL 3 | FM 3 | IRI 3 | ANSI 10 | UL 10 | FM 10 | IRI 10 | ANSI 25 | UL 25 | FM 25 | IRI 25 | |
| OPTION | | | | | | | | | | | | | | | | | | | | | | | | | | | | | | | | | | | | | | |
| | FURNACE OUTPUT (X10K) | ANSI 3:1 | UL 3:1 | FM 3:1 | IRI 3:1 | ANSI 10:1 | UL 10:1 | FM 10:1 | IRI 10:1 | ANSI 25:1 | UL 25:1 | FM 25:1 | IRI 25:1 | ANSI 3:1 | UL 3:1 | FM 3:1 | IRI 3:1 | ANSI 10:1 | UL 10:1 | FM 10:1 | IRI 10:1 | ANSI 25:1 | UL 25:1 | FM 25:1 | IRI 25:1 | ANSI 3:1 | UL 3:1 | FM 3:1 | IRI 3:1 | ANSI 10:1 | UL 10:1 | FM 10:1 | IRI 10:1 | ANSI 25:1 | UL 25:1 | FM 25:1 | IRI 25:1 | |
| | 015 | 14.00 | NA | NA | NA | 27.00 | NA | NA | NA | NA | NA | NA | NA | 4.00 | NA | NA | NA | 13.00 | NA | NA | NA | NA | NA | NA | NA | 4.00 | NA | NA | NA | 13.00 | NA | NA | NA | NA | NA | NA | NA | |
| | 020 | 14.00 | NA | NA | NA | 27.00 | NA | NA | NA | NA | NA | NA | NA | 4.00 | NA | NA | NA | 13.00 | NA | NA | NA | NA | NA | NA | NA | 4.00 | NA | NA | NA | 13.00 | NA | NA | NA | NA | NA | NA | NA | |
| | 025 | 14.00 | NA | NA | NA | 27.00 | NA | NA | NA | NA | NA | NA | NA | 4.00 | NA | NA | NA | 13.00 | NA | NA | NA | NA | NA | NA | NA | 4.00 | NA | NA | NA | 13.00 | NA | NA | NA | NA | NA | NA | NA | |
| | 030 | 14.00 | NA | NA | NA | 27.00 | NA | NA | NA | NA | NA | NA | NA | 4.00 | NA | NA | NA | 13.00 | NA | NA | NA | NA | NA | NA | NA | 4.00 | NA | NA | NA | 13.00 | NA | NA | NA | NA | NA | NA | NA | |
| | 035 | NA | 14.00 | NA | 27.00 | NA | 27.00 | NA | 27.00 | NA | NA | NA | NA | NA | 5.00 | NA | 4.00 | NA | 4.00 | NA | 4.00 | NA | NA | NA | NA | NA | 5.00 | NA | 4.00 | NA | 4.00 | NA | 4.00 | NA | NA | NA | NA | |
| | 040 | NA | 14.00 | NA | 27.00 | NA | 27.00 | NA | 27.00 | NA | NA | NA | NA | NA | 5.00 | NA | 5.00 | NA | 5.00 | NA | 5.00 | NA | NA | NA | NA | NA | 5.00 | NA | 5.00 | NA | 5.00 | NA | 5.00 | NA | 18.00 | NA | 18.00 | |
| | 045 | NA | 14.00 | NA | 27.00 | NA | 27.00 | NA | 27.00 | NA | NA | NA | NA | NA | 5.00 | NA | 5.00 | NA | 5.00 | NA | 5.00 | NA | NA | NA | NA | NA | 5.00 | NA | 5.00 | NA | 5.00 | NA | 5.00 | NA | 18.00 | NA | 18.00 | |
| | 050 | NA | 14.00 | NA | 27.00 | NA | 27.00 | NA | 27.00 | NA | NA | NA | NA | NA | 5.00 | NA | 5.00 | NA | 5.00 | NA | 5.00 | NA | NA | NA | NA | NA | 5.00 | NA | 5.00 | NA | 5.00 | NA | 5.00 | NA | 18.00 | NA | 18.00 | |
| | 060 | NA | 27.00 | NA | 27.00 | NA | 27.00 | NA | 27.00 | NA | 27.00 | NA | 27.00 | NA | 6.00 | NA | 6.00 | NA | 6.00 | NA | 6.00 | NA | NA | NA | NA | NA | 6.00 | NA | 6.00 | NA | 6.00 | NA | 6.00 | NA | 19.00 | NA | 19.00 | |
| | 075 | NA | 27.00 | NA | 27.00 | NA | 27.00 | NA | 27.00 | NA | 27.00 | NA | 27.00 | NA | 6.00 | NA | 7.00 | NA | 6.00 | NA | 6.00 | NA | NA | NA | NA | NA | 6.00 | NA | 7.00 | NA | 6.00 | NA | 7.00 | NA | 19.00 | NA | 19.00 | |
| | 085 | NA | 27.00 | NA | 27.00 | NA | 27.00 | NA | 27.00 | NA | 27.00 | NA | 27.00 | NA | 9.00 | NA | 8.00 | NA | 9.00 | NA | 9.00 | NA | NA | NA | NA | NA | 9.00 | NA | 8.00 | NA | 9.00 | NA | 8.00 | NA | 19.00 | NA | 19.00 | |
| | 100 | NA | 27.00 | NA | 27.00 | NA | 27.00 | NA | 27.00 | NA | 27.00 | NA | 27.00 | NA | 11.00 | NA | 9.00 | NA | 11.00 | NA | 11.00 | NA | NA | NA | NA | NA | 11.00 | NA | 9.00 | NA | 11.00 | NA | 9.00 | NA | 20.00 | NA | 20.00 | |
| | 125 | NA | 27.00 | NA | 27.00 | NA | 27.00 | NA | 27.00 | NA | 27.00 | NA | 27.00 | NA | 8.00 | NA | 7.00 | NA | 8.00 | NA | 8.00 | NA | NA | NA | NA | NA | 8.00 | NA | 7.00 | NA | 8.00 | NA | 7.00 | NA | 20.00 | NA | 20.00 | |
| | 150 | NA | 27.00 | NA | 27.00 | NA | 27.00 | NA | 27.00 | NA | 27.00 | NA | 27.00 | NA | 11.00 | NA | 9.00 | NA | 11.00 | NA | 11.00 | NA | NA | NA | NA | NA | 11.00 | NA | 9.00 | NA | 11.00 | NA | 9.00 | NA | 20.00 | NA | 20.00 | |
| | 175 | NA | 27.00 | NA | 27.00 | NA | 27.00 | NA | 27.00 | NA | 27.00 | NA | 27.00 | NA | 15.00 | NA | 12.00 | NA | 15.00 | NA | 15.00 | NA | NA | NA | NA | NA | 15.00 | NA | 12.00 | NA | 15.00 | NA | 12.00 | NA | 34.00 | NA | 34.00 | |
| | 200 | NA | 27.00 | NA | 27.00 | NA | 27.00 | NA | 27.00 | NA | 27.00 | NA | 27.00 | NA | 15.00 | NA | 12.00 | NA | 15.00 | NA | 15.00 | NA | NA | NA | NA | NA | 15.00 | NA | 12.00 | NA | 15.00 | NA | 12.00 | NA | 38.00 | NA | 38.00 | |
| | 225 | NA | NA | 27.00 | 27.00 | NA | 27.00 | 27.00 | 27.00 | NA | NA | 55.00 | 55.00 | NA | NA | 8.00 | 11.00 | NA | NA | 8.00 | 11.00 | NA | NA | 34.00 | 34.00 | NA | NA | 8.00 | 11.00 | NA | NA | 8.00 | 11.00 | NA | 34.00 | NA | 34.00 | |
| | 250 | NA | NA | 27.00 | 27.00 | NA | 27.00 | 27.00 | 27.00 | NA | NA | 55.00 | 55.00 | NA | NA | 8.00 | 11.00 | NA | NA | 8.00 | 11.00 | NA | NA | 35.00 | 35.00 | NA | NA | 8.00 | 11.00 | NA | NA | 8.00 | 11.00 | NA | 35.00 | NA | 35.00 | |
| | 275 | NA | NA | 27.00 | 27.00 | NA | 27.00 | 27.00 | 27.00 | NA | NA | 55.00 | 55.00 | NA | NA | 11.00 | 10.00 | NA | NA | 11.00 | 10.00 | NA | NA | 39.00 | 39.00 | NA | NA | 11.00 | 10.00 | NA | NA | 11.00 | 10.00 | NA | 39.00 | NA | 39.00 | |
| | 300 | NA | NA | 27.00 | 27.00 | NA | 27.00 | 27.00 | 27.00 | NA | NA | 55.00 | 55.00 | NA | NA | 11.00 | 11.00 | NA | NA | 11.00 | 11.00 | NA | NA | 40.00 | 40.00 | NA | NA | 11.00 | 11.00 | NA | NA | 11.00 | 11.00 | NA | 40.00 | NA | 40.00 | |
| | 325 | NA | NA | 27.00 | 27.00 | NA | 27.00 | 27.00 | 27.00 | NA | NA | 55.00 | 55.00 | NA | NA | 8.00 | 9.00 | NA | NA | 8.00 | 9.00 | NA | NA | 41.00 | 41.00 | NA | NA | 8.00 | 9.00 | NA | NA | 8.00 | 9.00 | NA | 41.00 | NA | 41.00 | |
| | 350 | NA | NA | 27.00 | 27.00 | NA | 27.00 | 27.00 | 27.00 | NA | NA | 55.00 | 55.00 | NA | NA | 8.00 | 9.00 | NA | NA | 8.00 | 9.00 | NA | NA | 48.00 | 48.00 | NA | NA | 8.00 | 9.00 | NA | NA | 8.00 | 9.00 | NA | 48.00 | NA | 48.00 | |
| | 375 | NA | NA | 27.00 | 27.00 | NA | 27.00 | 27.00 | 27.00 | NA | NA | 55.00 | 55.00 | NA | NA | 8.00 | 10.00 | NA | NA | 8.00 | 10.00 | NA | NA | 49.00 | 49.00 | NA | NA | 8.00 | 10.00 | NA | NA | 8.00 | 10.00 | NA | 49.00 | NA | 49.00 | |
| | 400 | NA | NA | 27.00 | 27.00 | NA | 27.00 | 27.00 | 27.00 | NA | NA | 55.00 | 55.00 | NA | NA | 9.00 | 10.00 | NA | NA | 9.00 | 10.00 | NA | NA | 48.00 | 48.00 | NA | NA | 9.00 | 10.00 | NA | NA | 9.00 | 10.00 | NA | 48.00 | NA | 48.00 | |

Note: Gas pressure requirements at the inlet to the main manual shutoff cock of the gas train.

TABLE 3-2A – PIPE SIZE REQUIRED

| INLET SIZE (NPT) | | | | | | | | | | | | |
|--|-------------|-----------|-----------|------------|--------------|------------|------------|-------------|--------------|------------|------------|-------------|
| | A03 | U03 | F03 | R03 | A10 | U10 | F10 | R10 | A25 | U25 | F25 | R25 |
| GAS BURNER PIPING/GAS BURNER TURN DOWN | | | | | | | | | | | | |
| | ANSI 3 | UL 3 | FM 3 | IRI 3 | ANSI 10 | UL 10 | FM 10 | IRI 10 | ANSI 25 | UL 25 | FM 25 | IRI 25 |
| FURNACE OUTPUT (X10K) | ANSI 3:1 | UL 3:1 | FM 3:1 | IRI 3:1 | ANSI 10:1 | UL 10:1 | FM 10:1 | IRI 10:1 | ANSI 25:1 | UL 25:1 | FM 25:1 | IRI 25:1 |
| 015 | 0.75 | NA | NA | NA | 1.00 | NA | NA | NA | NA | NA | NA | NA |
| 020 | 0.75 | NA | NA | NA | 1.00 | NA | NA | NA | NA | NA | NA | NA |
| 025 | 0.75 | NA | NA | NA | 1.00 | NA | NA | NA | NA | NA | NA | NA |
| 030 | 0.75 | NA | NA | NA | 1.00 | NA | NA | NA | NA | NA | NA | NA |
| 035 | NA | 1.00 | NA | 1.00 | NA | 1.00 | NA | 1.00 | NA | NA | NA | NA |
| 040 | NA | 1.00 | NA | 1.00 | NA | 1.00 | NA | 1.00 | NA | 1.00 | NA | 1.00 |
| 045 | NA | 1.00 | NA | 1.00 | NA | 1.00 | NA | 1.00 | NA | 1.00 | NA | 1.00 |
| 050 | NA | 1.00 | NA | 1.00 | NA | 1.00 | NA | 1.00 | NA | 1.00 | NA | 1.00 |
| 060 | NA | 1.00 | NA | 1.00 | NA | 1.00 | NA | 1.00 | NA | 1.00 | NA | 1.00 |
| 075 | NA | 1.00 | NA | 1.00 | NA | 1.00 | NA | 1.00 | NA | 1.25 | NA | 1.25 |
| 085 | NA | 1.00 | NA | 1.00 | NA | 1.00 | NA | 1.00 | NA | 1.25 | NA | 1.25 |
| 100 | NA | 1.00 | NA | 1.00 | NA | 1.00 | NA | 1.00 | NA | 1.25 | NA | 1.25 |
| 125 | NA | 1.25 | NA | 1.25 | NA | 1.25 | NA | 1.25 | NA | 1.50 | NA | 1.50 |
| 150 | NA | 1.25 | NA | 1.25 | NA | 1.25 | NA | 1.25 | NA | 1.50 | NA | 1.50 |
| 175 | NA | 1.25 | NA | 1.25 | NA | 1.25 | NA | 1.25 | NA | 1.50 | NA | 1.50 |
| 200 | NA | 1.50 | NA | 1.50 | NA | 1.50 | NA | 1.50 | NA | 1.50 | NA | 1.50 |
| 225 | NA | NA | 2.00 | 1.50 | NA | NA | 2.00 | 1.50 | NA | NA | 2.00 | 2.00 |
| 250 | NA | NA | 2.00 | 1.50 | NA | NA | 2.00 | 1.50 | NA | NA | 2.00 | 2.00 |
| 275 | NA | NA | 2.00 | 1.50 | NA | NA | 2.00 | 2.00 | NA | NA | 2.00 | 2.00 |
| 300 | NA | NA | 2.00 | 1.50 | NA | NA | 2.00 | 2.00 | NA | NA | 2.00 | 2.00 |
| 325 | NA | NA | 2.50 | 2.50 | NA | NA | 2.50 | 2.50 | NA | NA | 2.50 | 2.50 |
| 350 | NA | NA | 2.50 | 2.50 | NA | NA | 2.50 | 2.50 | NA | NA | 2.50 | 2.50 |
| 375 | NA | NA | 2.50 | 2.50 | NA | NA | 2.50 | 2.50 | NA | NA | 2.50 | 2.50 |
| 400 | NA | NA | 2.50 | 2.50 | NA | NA | 2.50 | 2.50 | NA | NA | 2.50 | 2.50 |



| FURNACE OUTPUT | A |
|----------------|-------|
| 15 | 21.83 |
| 20 | 21.83 |
| 25 | 21.83 |
| 40 | 23.66 |
| 50 | 23.66 |
| 75 | 28.15 |
| 100 | 28.14 |
| 125 | 35.12 |
| 150 | 35.12 |
| 175 | 35.12 |
| 200 | 35.12 |
| 250 | 41.36 |
| 300 | 41.36 |
| 350 | 47.36 |
| 400 | 47.36 |

LD13304

FIG. 3-21 – GAS FURNACE FUEL VENTING SYSTEM

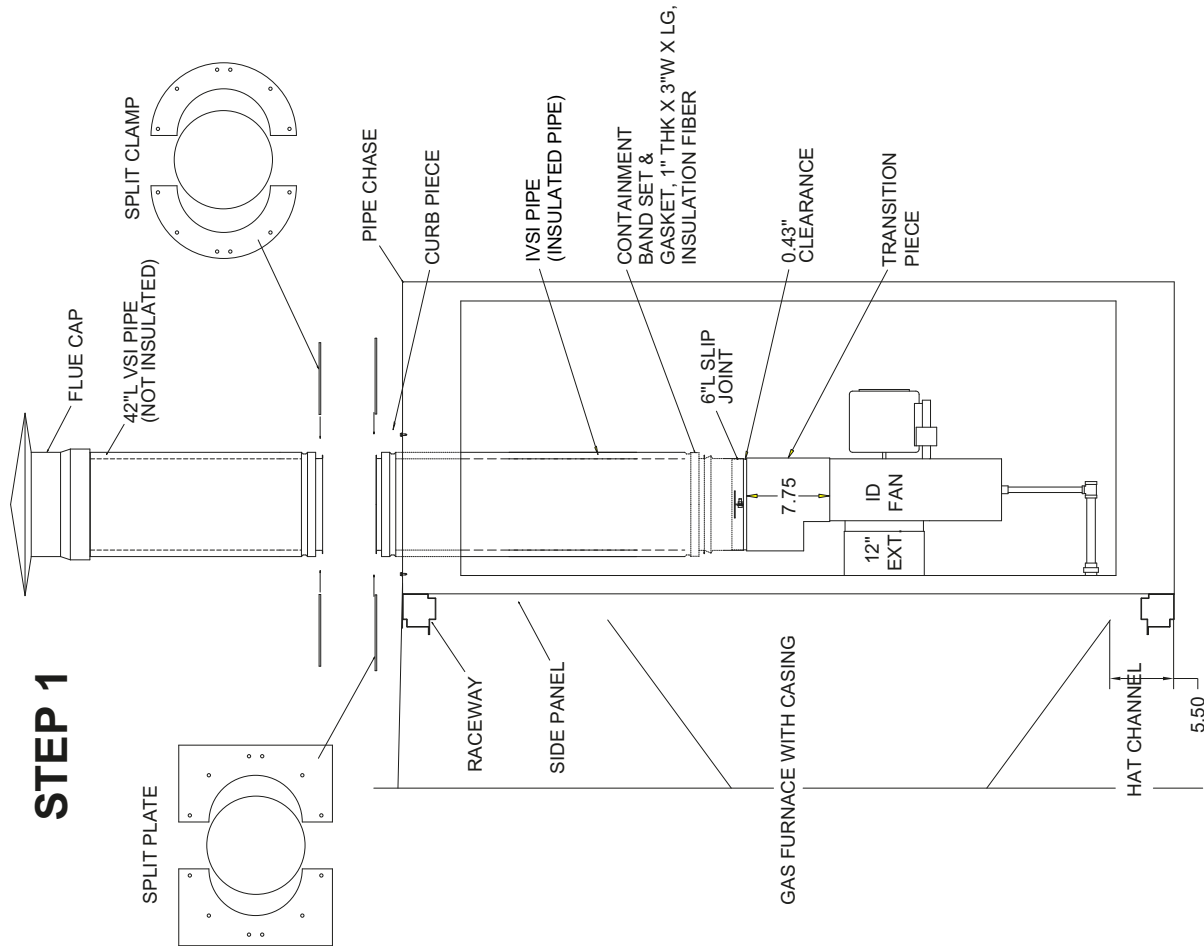
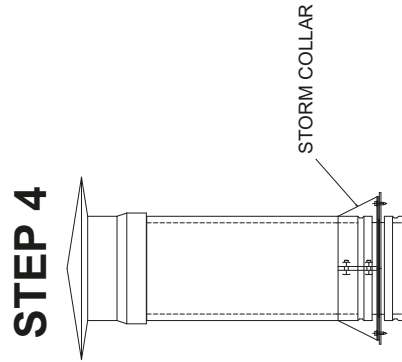
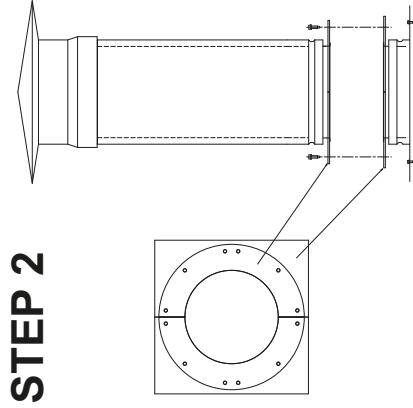
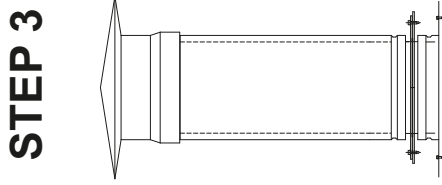


FIG. 3-22 – GAS FURNACE FUEL VENTING SYSTEM

FOR REFERENCE ONLY

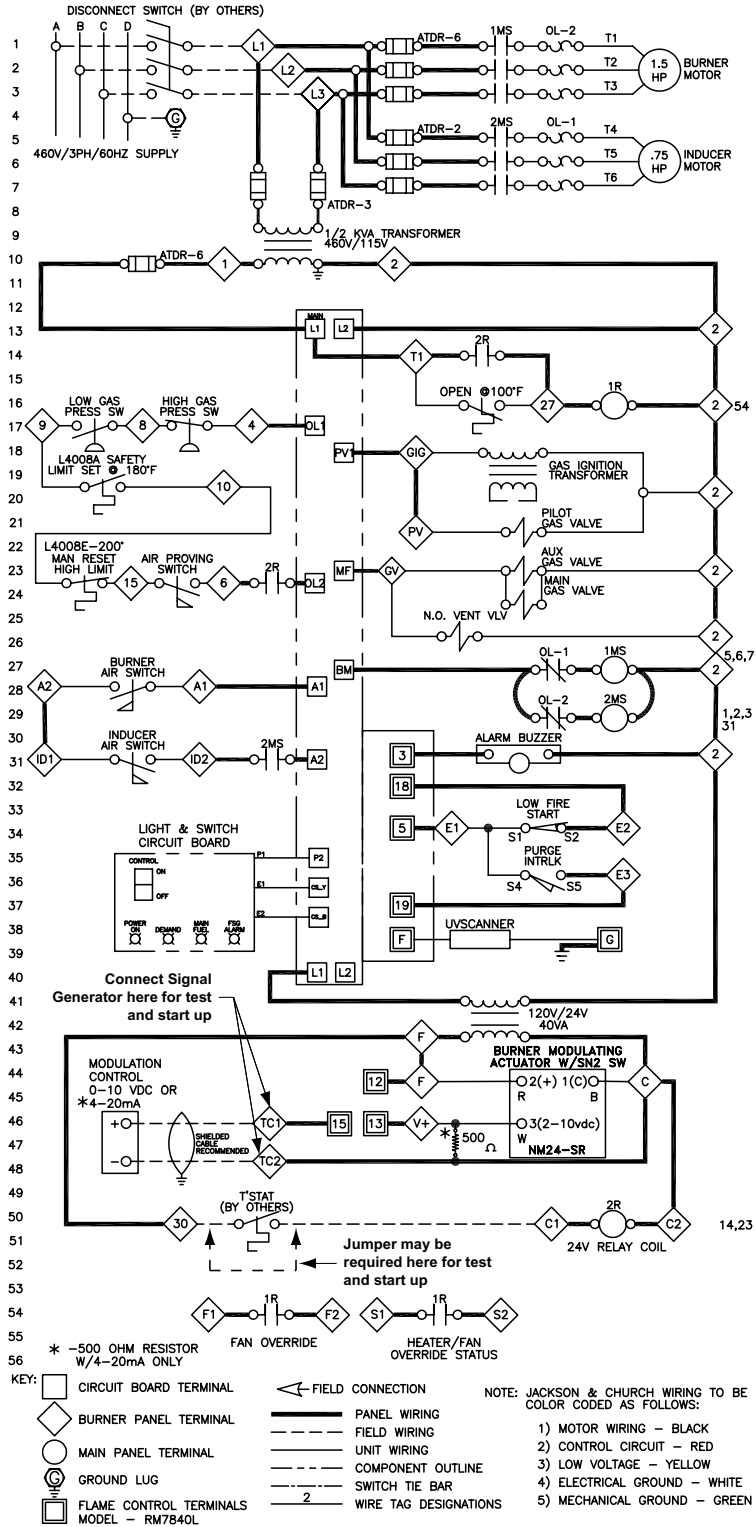


FIG. 3-23 – TYPICAL WIRING DIAGRAM

LD13315

TABLE 3-3 – BURNER TEMPERATURE RISE

| CFM | TEMPERATURE RISE (°F) | | | INTERNAL PRESSURE DROP “ WC |
|--------|-----------------------|-----------|-----------|--------------------------------------|
| | DF- 15 | DF- 20 | DF- 25 | |
| 1,500 | 91 | -- | -- | 0.17 |
| 2,000 | 68 | 91 | -- | 0.29 |
| 2,500 | 55 | 73 | 91 | 0.46 |
| 3,000 | 46 | 61 | 76 | 0.65 |
| 3,500 | 40 | 52 | 65 | 0.89 |
| 4,000 | 35 | 46 | 57 | 1.17 |
| 4,500 | 31 | 41 | 51 | 1.47 |
| 5,248 | 26 | 35 | 44 | 2 |
| | DF- 30 | DF- 35 | DF- 40 | |
| 3,000 | 95 | -- | -- | 0.22 |
| 3,500 | 82 | 91 | -- | 0.31 |
| 4,000 | 71 | 79 | 95 | 0.41 |
| 4,500 | 63 | 70 | 85 | 0.54 |
| 5,000 | 57 | 63 | 76 | 0.66 |
| 5,500 | 52 | 57 | 69 | 0.84 |
| 6,000 | 47 | 53 | 63 | 1 |
| 6,500 | 43 | 47 | 58 | 1.2 |
| 7,000 | 40 | 46 | 54 | 1.45 |
| 8,440 | 32.9 | 38.4 | 43.9 | 2 |
| | DF- 45 | DF- 50 | | |
| 4,500 | 88 | -- | | 0.39 |
| 5,000 | 80 | 90 | | 0.47 |
| 5,500 | 72 | 82 | | 0.55 |
| 6,000 | 66 | 75 | | 0.65 |
| 6,500 | 61 | 69 | | 0.75 |
| 7,000 | 57 | 64 | | 0.86 |
| 7,500 | 53 | 60 | | 0.98 |
| 8,000 | 50 | 56 | | 1.1 |
| 8,500 | 47 | 53 | | 1.23 |
| 9,000 | 46 | 50 | | 1.38 |
| 10,725 | 38.8 | 43.2 | | 2 |

| CFM | TEMPERATURE RISE (°F) | | | INTERNAL PRESSURE DROP “ WC |
|--------|-----------------------|------------|--|--------------------------------------|
| | DF- 60 | DF- 75 | | |
| 6,000 | 91 | -- | | 0.44 |
| 6,500 | 84 | -- | | 0.52 |
| 7,000 | 78 | -- | | 0.6 |
| 7,500 | 73 | 91 | | 0.68 |
| 8,000 | 68 | 85 | | 0.78 |
| 9,000 | 61 | 76 | | 0.98 |
| 10,000 | 55 | 68 | | 1.2 |
| 11,000 | 50 | 62 | | 1.4 |
| 12,000 | 46 | 57 | | 1.7 |
| 12,900 | 43 | 53.8 | | 2 |
| | DF- 85 | DF- 100 | | |
| 8,500 | 91 | -- | | 0.47 |
| 9,000 | 86 | -- | | 0.52 |
| 9,500 | 81 | -- | | 0.58 |
| 10,000 | 77 | 91 | | 0.64 |
| 10,500 | 74 | 87 | | 0.7 |
| 11,000 | 70 | 83 | | 0.76 |
| 12,000 | 64 | 76 | | 0.9 |
| 13,000 | 59 | 70 | | 1.05 |
| 14,000 | 55 | 65 | | 1.25 |
| 15,000 | 51 | 61 | | 1.4 |
| 16,000 | 49 | 57 | | 1.6 |
| 17,000 | 46 | 54 | | 1.75 |
| 17,825 | 44 | 52 | | 2 |

TABLE 3-3 - BURNER TEMPERATURE RISE (CONT)

| CFM | TEMPERATURE RISE (°F) | | | | INTERNAL PRESSURE DROP " WC |
|--------|-----------------------|--------|--|--|-----------------------------|
| | DF-125 | DF-150 | | | |
| 13,000 | 89 | -- | | | 0.48 |
| 14,000 | 83 | -- | | | 0.56 |
| 15,000 | 77 | 93 | | | 0.65 |
| 16,000 | 72 | 87 | | | 0.73 |
| 17,000 | 68 | 82 | | | 0.82 |
| 18,000 | 64 | 77 | | | 0.92 |
| 19,000 | 61 | 73 | | | 1.03 |
| 20,000 | 58 | 69 | | | 1.13 |
| 21,000 | 55 | 66 | | | 1.25 |
| 22,000 | 52 | 63 | | | 1.35 |
| 23,000 | 50 | 60 | | | 1.5 |
| 24,000 | 48 | 58 | | | 1.3 |
| 25,000 | 46 | 55 | | | 1.75 |
| 26,315 | 43.6 | 52 | | | 2 |
| | DF-175 | DF-200 | | | |
| 17,000 | 95 | -- | | | 0.45 |
| 18,000 | 90 | -- | | | 0.52 |
| 19,000 | 85 | -- | | | 0.57 |
| 20,000 | 81 | 93 | | | 0.63 |
| 21,000 | 77 | 88 | | | 0.7 |
| 22,000 | 74 | 85 | | | 0.76 |
| 23,000 | 71 | 81 | | | 0.82 |
| 24,000 | 68 | 78 | | | 0.9 |
| 26,000 | 62 | 71 | | | 1.05 |
| 28,000 | 58 | 66 | | | 1.25 |
| 30,000 | 54 | 62 | | | 1.4 |
| 32,000 | 51 | 58 | | | 1.6 |
| 34,000 | 48 | 54 | | | 1.8 |
| 35,635 | 45.5 | 52 | | | 2 |

| CFM | TEMPERATURE RISE (°F) | | | | INTERNAL PRESSURE DROP " WC |
|--------|-----------------------|--------|--------|--------|-----------------------------|
| | DF-225 | DF-250 | DF-275 | DF-300 | |
| 24,000 | 87 | -- | -- | -- | 0.337 |
| 27,000 | 77 | 86 | 92.5 | -- | 0.427 |
| 30,000 | 69 | 77 | 83.3 | 90.8 | 0.527 |
| 33,000 | 63 | 70 | 75.8 | 82.5 | 0.637 |
| 36,000 | 58 | 64 | 69.5 | 75.7 | 0.758 |
| 39,000 | 53 | 59 | 64 | 70 | 0.89 |
| 42,000 | 50 | 55 | 59.5 | 65 | 1.035 |
| 45,000 | 46 | 51 | 55.6 | 60.6 | 1.185 |
| 48,000 | 43 | 48 | 52.1 | 55.8 | 1.35 |
| 51,000 | 41 | 45 | 50 | 53.5 | 1.525 |
| 54,000 | 39 | 43 | 47 | 50.5 | 1.71 |
| 58,475 | 35 | 39.5 | 43.5 | 47.5 | 2 |
| | DF-325 | DF-350 | DF-375 | DF-400 | |
| 31,565 | 95 | -- | -- | -- | 0.4 |
| 35,290 | 85 | 92 | -- | -- | 0.5 |
| 41,755 | 72 | 78 | 83 | 89 | 0.7 |
| 47,345 | 64 | 68 | 73 | 78 | 0.9 |
| 52,340 | 57 | 62 | 66 | 71 | 1.1 |
| 54,665 | 55 | 59 | 64 | 68 | 1.2 |
| 59,045 | 51 | 55 | 59 | 63 | 1.4 |
| 63,125 | 48 | 51 | 55 | 59 | 1.6 |
| 66,950 | 45 | 48 | 52 | 55 | 1.8 |
| 70,573 | 42.6 | 45.9 | 49.2 | 52.4 | 2 |

