



High Wall Inverter

Service Manual

New Released

Form: MHJ(K)EJMEXCORX-191203

High Wall Inverter

R-410A 60Hz

YHJE12/18/24ZJMEXCORX

YHKE12/18/24ZJMEXCORX



Issue Date
Dec 3rd, 2019

CONTENTS

<i>Part I : Installation and Maintenance</i>	<i>1</i>
1. Main Tools for Installation and Maintenance.....	1
2. Installation.....	2
2-1 Notes for Installation	2
2-2 Installation of Indoor Unit.....	3
2-3 Installation of outdoor Unit	6
2-4 Check after installation and test operation	9
3. Maintenance.....	11
3-1 Troubleshooting Guide	11
3-2 Common Parameters	33
3-3 Troubleshooting for Normal Malfunction.....	35
4. Removal Procedure.....	43
4-1 Indoor Unit	43
4-2 Outdoor Unit.....	59
Appendix.....	65
Common Sensor R-T Analysis Table.....	65

Part I : Installation and Maintenance

1. Main Tools for Installation and Maintenance

Screwdriver , Wire stripper	Tapeline , Spirit level	Allen wrench , Wrench
		
Hammer , Electric hammer	Water drill punch , Drill	Forming Drill
		
Cutting Knife	Belling Expander	Thermometer , Electro Probe
		
Pressure Gage	Pliers , Clip-on Ammeter	Vacuum Pump
		
Soldering Set	Refrigerant	Safety Belt , Safety Rope
		

2. Installation

2-1 Notes for Installation

Important Notices

- Before installation, please contact with local authorized maintenance center, if unit is not installed by the authorized maintenance center, the malfunction may not solved, due to discommodious contact.
- The air conditioner must be installed by professionals according to the national wiring rules and this manual.
- To move and install air conditioner to another place, please contact our local special service center.

Requirements For Installation Position

- Avoid places of inflammable or explosive gas leakage or where there are strongly aggressive gases.
- Avoid places subject to strong artificial electric/magnetic fields.
- Avoid places subject to noise and resonance.
- Avoid severe natural conditions (e.g. heavy lampblack, strong sandy wind, direct sunshine or high temperature heat sources).
- Avoid places within the reach of children.
- Shorten the connection between the indoor and outdoor units.
- Select where it is easy to perform service and repair and where the ventilation good.
- The outdoor unit shall not be installed in any way that could occupy an aisle, stairway, exit, fire escape, catwalk or any other public area.
- The outdoor unit shall be installed as far as possible from the doors and windows of the neighbors as well as the green plants.

Requirements for operations at raised height

- When carrying out installation at 2m or higher above the base level, safety belts must be worn and ropes of sufficient strength be securely fasten to the outdoor unit, to prevent falling that could cause personal injury or death as well as property loss.

Requirements of the mounting structure

- The mounting rack must meet the relevant national or industrial standards in terms of strength with welding and connection areas rustproofed.
- The mounting rack and its load carry surface shall be able to withstand 4 times or above the weight of the unit, or 200kg, whichever is heavier.
- The mounting rack of the outdoor unit shall be fastened with expansion bolt.
- Ensure the secure installation regardless of what type of wall on which it is installed, to prevent potential dropping that could hurt people.

Electrical Safety Requirements

- Be sure to use the rated voltage and air conditioners dedicated circuit for the power supply, and the power cord diameter must meet the national requirements.
- Be sure to use the rated voltage and air conditioners dedicated
- When the maximum current of air conditioner is $\geq 16A$, it must use the air switch or leakage protection switch equipped with protection devices.
- The normal operating range is 90%-110% of the local rated voltage.
- The minimum clearance between the air conditioner and the combustibles is 1.5

- m.
- The power cable enables communication between the indoor and outdoor units. You must first choose the right cable size before preparing it for connection.
- ✚ **Grounding Requirements**
- The air conditioner is the type I electrical appliance and must ensure a reliable grounding.
- Do not connect the grounding wire to a gas pipe, water pipe, lightning rod, telephone line, or a circuit poorly grounded to the earth.
- The grounding wire is specially designed and shall not be used for other purpose, nor shall it be fastened with a common tapping screw.
- ✚ **Others**
- The connection method of the air conditioner and the power cord and the interconnection method of each independent element shall be subject to the wiring diagram affixed to the machine.
- The model and rating value of the fuse shall be subject to the silkscreen on corresponding controller or fuse sleeve.

2-2 Installation of Indoor Unit

➤ Installation Parts-checking

Packing list of the indoor unit

NO.	Name	Quantity	Unit
1	Indoor Unit	1	Set
2	Remote Controller	1	PC
3	Batteries(7#)	2	PC
4	Instructions	1	Set
5	Drain pipe	1	PC

NOTE:

※ All accessories shall be subject to actual packaging material, and if there is any difference, please understand.

➤ Selection of Installation location

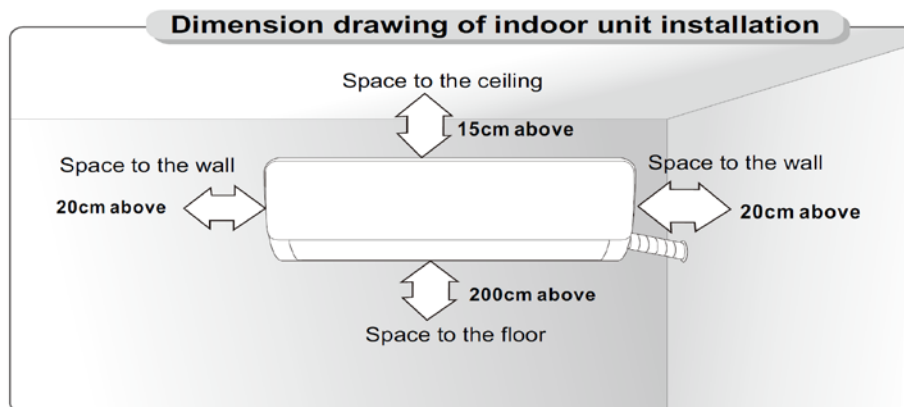

➤ Mounting plate

1. The wall for installation of the indoor unit shall be hard and firm, so as to prevent vibration.
2. Use the "+" type screw to fasten the peg board, horizontally mount the peg board on the wall, and ensure the lateral horizontal and longitudinal vertical.
3. Pull the peg board by hand after the installation, to confirm whether it is solid.

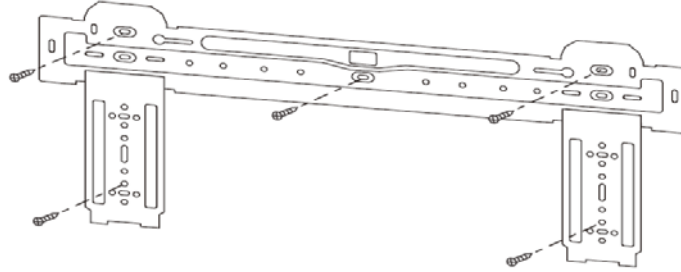

➤ Wall-through Hole

1. Make a hole with an electric hammer or a water drill at the predetermined position on the wall for piping, which shall slant outwardly by 5°-10°.
2. To protect the piping and the cables from being damaged running through the wall, and from the rodents that may inhabit in the hollow wall, a pipe protecting ring shall be installed and sealed with putty.

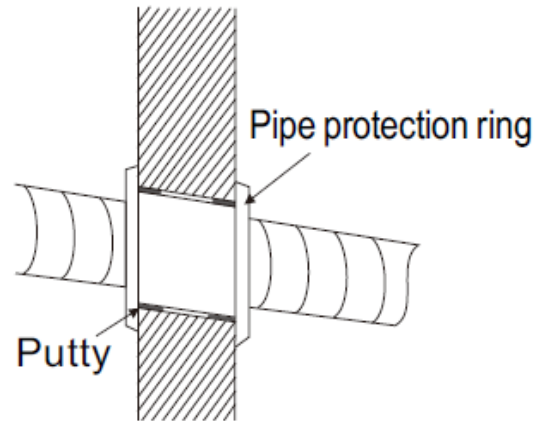

Note: Usually, the wall hole is $\Phi 60\text{mm}$ ~ $\Phi 80\text{mm}$. Avoid pre-buried power wire and hard wall when making the hole.

➤ Route of Pipeline

1. Depending on the position of the unit, the piping may be routed sideway from the left or the right (Fig 1), or vertically from the back(Fig 2)(depending on the pipe length of the indoor unit). In the case of sideway routing, cut off the outlet cutting stock of the opposite side.
2. The power cord may be routed separately from the piping. Cut off the outlet cutting stock and then run the power cord through the hole, keeping the remaining part as a protection from rodents.

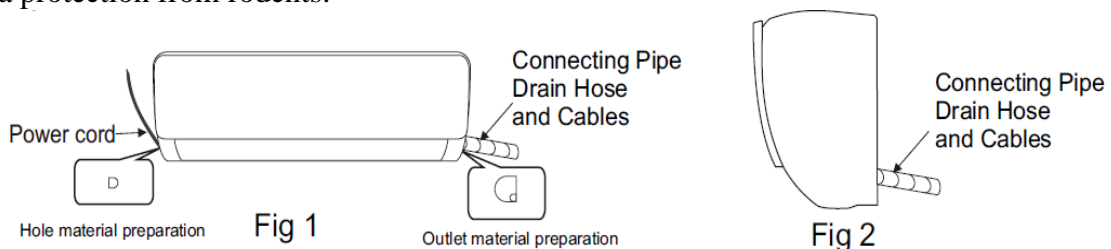

➤ Drain pipe connection

1. Remove the mountings and pull the indoor unit pipe out of the housing.

2. Connect the connecting pipe to the indoor unit:

Aim at the pipe center, tighten the Taper nut with fingers, and then tighten the T nut with a torque wrench, and the direction is shown in diagram on the right. The torque used is shown in the following table.

Tightening torque table

The size of pipe(mm)	Torque(N·m)
Φ6/Φ6.35	15 ~ 25
Φ9 /Φ9.5 2	35 ~ 40
Φ12/Φ12.7	45 ~ 60
Φ15.88	73 ~ 78
Φ19.05	75 ~ 80

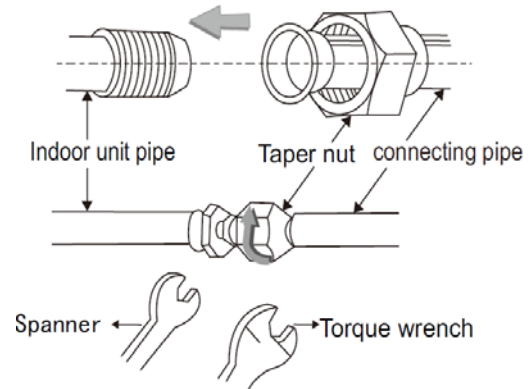

➤ **Wrap the Piping**

1. Use the insulation sleeve to wrap the joint part the indoor unit and the connection pipe, and then use insulating material to pack and seal insulation pipe, to prevent generation of condensate water on the joint part.

2. Connect the water outlet with drain pipes, and make the connection pipe, cables, and the drain hose straight.

3. Use plastic cable ties to wrap the connecting pipes, cables and drain hose. Run the pipe sloping downward.

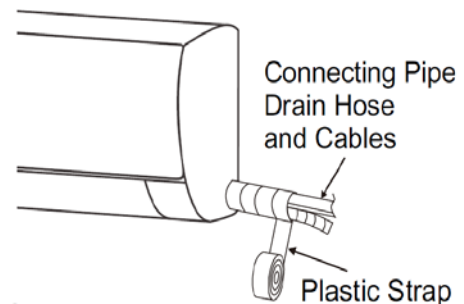

➤ **Fixing the indoor unit**

1. Hang the indoor unit on the peg board, and move the unit from left to right to ensure that the hook is properly positioned in the peg board.

2. Push toward the lower left side and the upper right side of the unit toward the peg board, until the hook is embedded in the slot and makes a "click" sound.

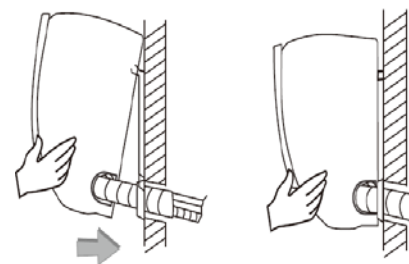

➤ **Electric Connection Requirement**

- Loosen the screws and remove from the unit.
- Connect the cables respectively to the corresponding terminals of the terminal board of the indoor unit (see the wiring diagram), and if there are signals connected to the plug, just conduct butt joint.

●Ground wire: Remove the grounding screw out of the electric bracket, cover the grounding wire end onto the grounding screw and screw it

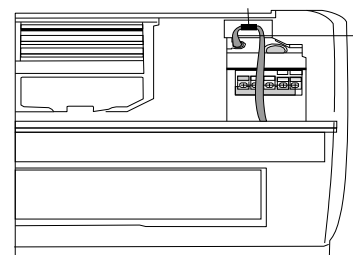

into the grounding hole.

- Fix the cable reliably with fasteners (Pressing board).
- Put the E-parts cover back in its original place and fasten it with screws.

Wiring Diagram

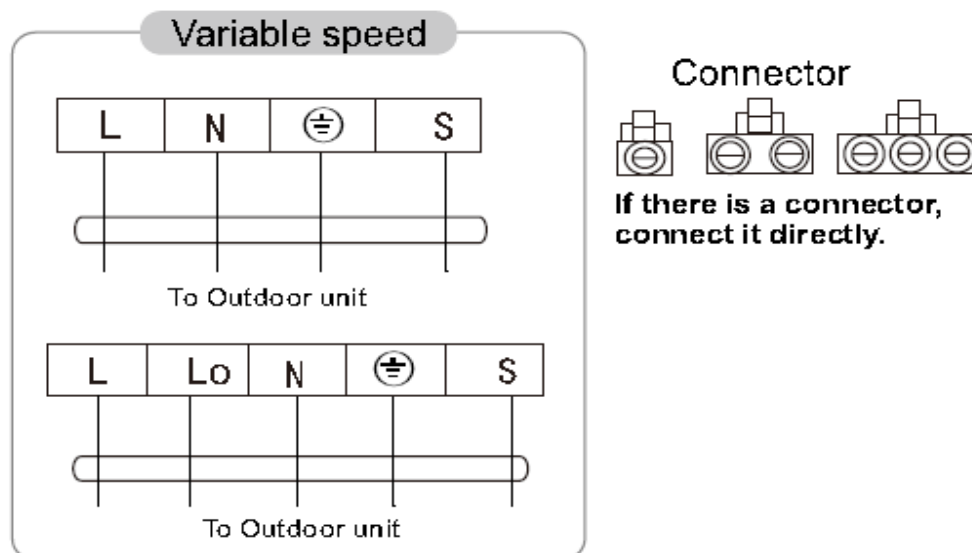

NOTE:

- ※ This manual usually includes the wiring mode for the different kind of A/C. We cannot exclude the possibility that some special type of wiring diagrams are not included.
- ※ The diagram are for reference only. If the entity is difference with this wiring diagram, please refer to the detailed wiring diagram adhered on the unit which you purchased.

2-3 Installation of outdoor Unit

➤ **Packing list of the outdoor unit**

NO.	Name	Quantity	Unit
1	Outdoor Unit	1	Set
2	Connecting pipe	2	PC
3	Plastic Strap	1	ROLL
4	Pipe Protection Ring	1	Set
5	Luting (putty)	1	PACKET

➤ **Selection of Installation location**

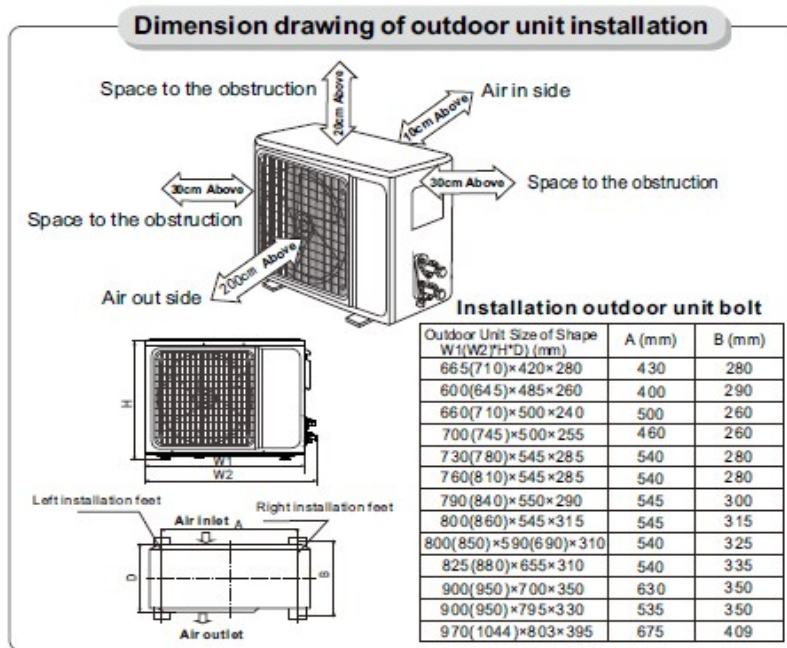

➤ **Install the connection pipe**

Connect the Outdoor Unit with Connecting Pipe: Aim the counter-bore of the connecting pipe at the stop valve, and tighten the Taper nut with fingers. Then tighten the Taper nut with a torque wrench.

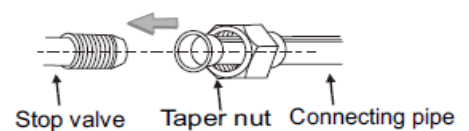

★ When prolonging the piping, extra amount of refrigerant must be added so that the operation and performance of the air conditioner will not be compromised.

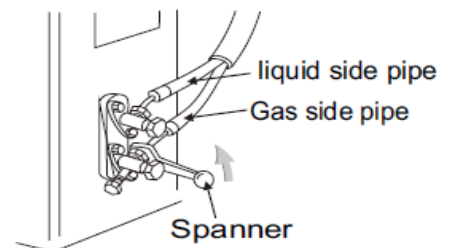

Piping length	Amount of refrigerant to be added	
≤5M	Not needed	
5- 15M	CC≤12000Btu	20g/m
	CC≥18000Btu	30g/m

Note: This table is for reference only.

➤ **Wiring Connection**

1. Loosen the screws and remove E-parts cover from the unit.
2. Connect the cables respectively to the corresponding terminals of the terminal board of the outdoor unit (see the wiring diagram), and if there are signals connected to the plug, just conduct butt joint.
3. Ground wire: Remove the grounding screw out of the electric bracket, cover the grounding wire end onto the grounding screw and screw it into the grounding hole.
4. Fix the cable reliably with fasteners (Pressing board).
5. Put the E-parts cover back in its original place and fasten it with screws.

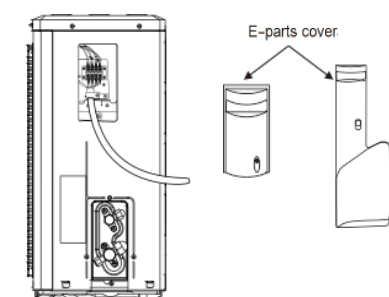

Wiring Diagram

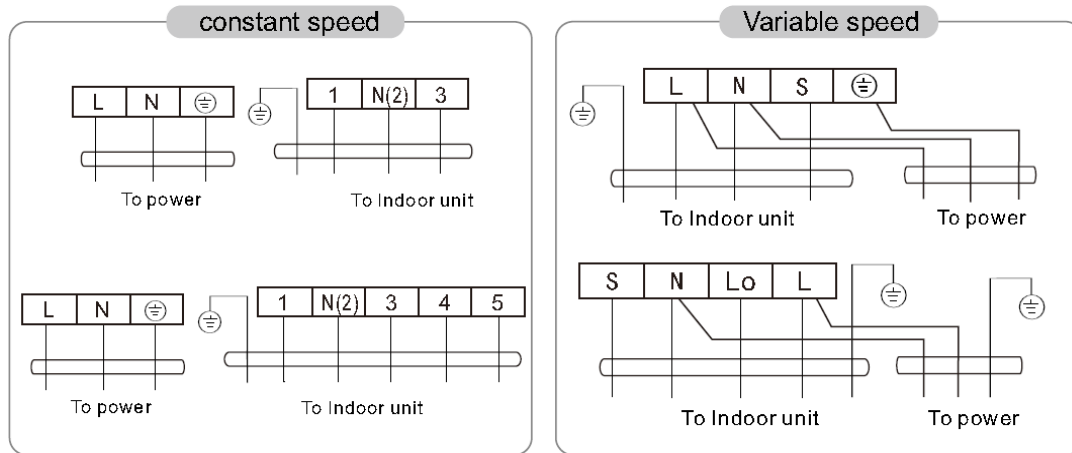

Connector



If there is a connector, connect it directly.

NOTE:

※ This manual usually includes the wiring mode for the different kind of A/C. We cannot exclude the possibility that some special type of wiring diagrams are not included.

※ The diagram are for reference only. If the entity is difference with this wiring diagram, please refer to the detailed wiring diagram adhered on the unit which you purchased.

➤ **Expelling the air**

★ **Outdoor unit refrigerant discharging method**

After the pipe side connection is complete, proceed as follows.

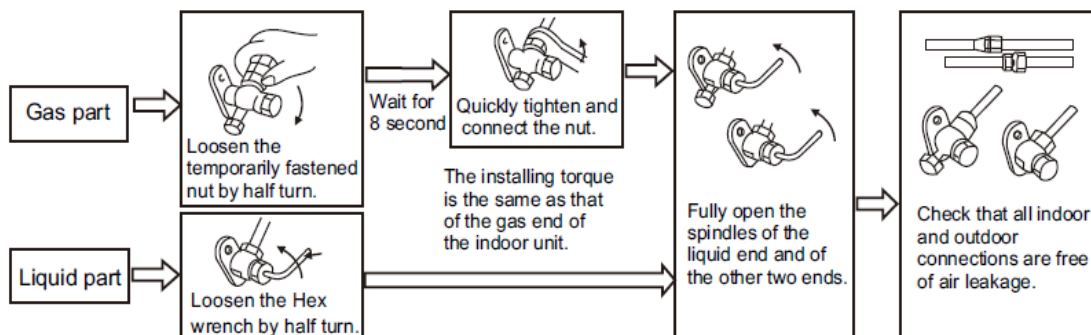

★ **Vacuum Pumping Method (R410A refrigerant evacuation must use the vacuum pumping method)**

Before working on the air conditioner, remove the cover of the stop valve(gas and liquid valves)and be sure to retighten it afterward.(to prevent the potential air leakage)

1. To prevent air leakage and spilling tighten all connecting nut of all flare tubes.
2. Connect the stop valve, charge hose, manifold valve, and vacuum pump.
3. Fully open the handle Lo of the manifold valve and apply vacuum for at least 15 minutes and check that the compound vacuum gauge reads -0.1MPa(-76cmHg).
4. After applying vacuum, fully open the stop valve with a hex wrench.
5. Check that both indoor and outdoor connections are free of air leakage.

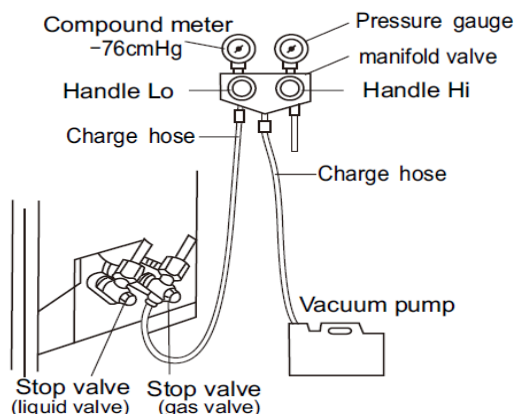

➤ **Outdoor condensation drainage(Heat pump type only)**

When the unit is heating, the condensing water and defrosting water can be out reliably through the drain house.

Installation:

Install the outdoor drain elbow in $\Phi 25$ hole on the base plate, and joint the drain hose to the elbow, so that the waste water formed in the outdoor unit can be drained out to a proper plate.

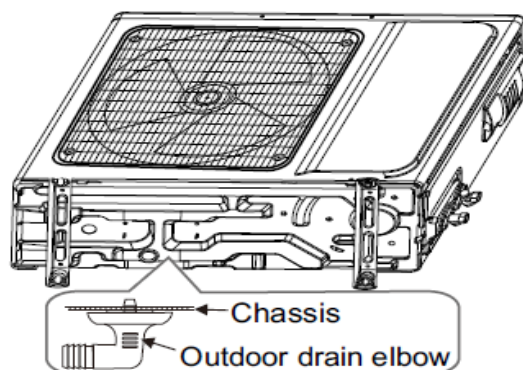

2-4 Check after installation and test operation

1. Check after installation

★ **Electrical Safety Check**

- ① If the supply voltage is as required.
- ② If there is any faulty or miss connection in each of the power, signal and grounding wires.
- ③ If the grounding wire of the air conditioner is securely grounded.

★ **Installation Safety Check**

- ① If the installation is secure.
- ② If the water drain is smooth.
- ③ If the wiring and piping are correctly installed.
- ④ Check that no foreign matter or tools are left inside the unit.

★ Leak test of the refrigerant

Depending on the installation method, the following methods may be used to check for suspect leak, on areas such as the four connections of the outdoor unit and the cores of the cut-off valves and t-valves:

- ① Bubble method: Apply of spray a uniform layer of soap water over the suspected leak spot and observe carefully for bubble.
- ② Instrument method: Checking for leak by pointing the probe of the leak detector according to the instruction to the suspect points of leak.

2. Test operation

★ Test preparation

- ※Verify that all piping and connection cables are well connected.
- ※Confirm that the valves at the gas side the liquid-side are fully open.
- ※Connect the power cord to an independent power socket.
- ※Install batteries in remote control.

★ Test Operation method

- ① Turn on the power and push the ON/OFF switch button of the remote controller to start the air conditioner.
- ② Select COOL, HEAT (not available on cool-only models), SWING and other operation modes with the remote controller and see if the operation is ok.

3. Maintenance

3-1 Troubleshooting Guide

Many error codes many appears on this air conditionor, and this troubleshooting guide is prepared for the maintenance personnel to detect the error position and the parts to be replaced during the troubleshooting process. In this Guide, the Troubleshooting Method is guided by the Error Name, and the Reference Code under the General Index is the error code of the internal unit of the mainstream model supplied by the Company.

Example: “internal coil sensor error” is coded as E3 in the error code of the internal unit, but appears as flash-out via the trouble light of the external machine. However, their troubleshooting method is the same, and use the same table as well.

General index:

No.	Error Name	Reference Code
1	Internal temperature sensor error	E1
2	External coil sensor error	E2
3	Internal coil sensor error	E3
4	Internal fan error of wall mounted air conditioner (PG motor)	E4
5	Internal fan error of wall mounted air conditioner (DC motor)	E4
6	Sliding door error of floor standing	E4
7	Internal and external communication error	E5 (5E)
8	External DC fan error (3-core terminal motor)	F0
9	Module protection error	F1
10	PFC protection error	F2
11	Compressor startup error	F3
12	Exhaust sensor error	F4
13	Pressing top head sensor error	F5
14	External temperature sensor error	F6
15	OVP or UVP error	F7
16	Main external control panel and module panel communication error	F8
17	Outdoor EE error	F9
18	Recirculated sensor error (four-way valve switch error)	FA
19	Cabinet internal fan error (see E4 for troubleshooting)	Fb
20	Function protection prompt of frequency conversion external machine	See the Error List

Example:

Explanation of error	Cause: explain the principle of the specific error. Inspection path: The basic order of troubleshooting. Related key position
Tools required for inspection	Tools that should be carried for such troubleshooting, and replacing parts that may be necessary for such error.
Frequent problematic part	Any possibly broken part related to the error may be the parts that need to be replaced.
Inspection procedure and key points	All the troubleshooting procedures for the reference of maintenance staff are prepared from simple to complex, from surface to internal, and from test to replacement. □ Although these key points do not cover all the error, and difficult or special problems are not included as well, but they can cover most of the common error.
Special attention	Here are some often-overlooked problems for the reference of the maintenance personnel.

The problems in the market are always more than we think, so it is necessary for the maintenance personnel to understand the principle of air conditioning operation, and to make a flexible judgment of the fault in combination with the actual conditions. We welcome the maintenance personnel to constantly put forward new problems in the actual work, record the solutions and enrich our troubleshooting guide list.

(1) E1- internal temperature sensor error

<p>Explanation of error</p>	<p>Cause: The detection of short circuit or open circuit of internal temperature sensor during the inspection of main control panel in the internal machine, indicated by “internal temperature sensor error”. Inspection path: Sensor→Sensor wire→Connectors→Main internal control panel</p>
<p>Tools required for inspection</p>	<p>Multimeter, 15KΩ standard sensor (25℃)</p>
<p>Frequent problematic part</p>	<p>Internal temperature sensor, main internal control panel</p>
<p>Inspection procedure and key points</p>	<ol style="list-style-type: none"> 1. Check whether there’s resistance problem, short circuit or open circuit in the sensor; the resistance value shall be within a reasonable range (15KΩ under the temperature of 25℃ for frequency conversion machine) 2. Check whether the sensor wire is broken. 3. Check whether the terminal connectors are well fixed; check whether the weld between the terminal and the main control panel is loose, and pull the terminal slightly for inspection if necessary. 4. Check whether the sensor is affected with damp. 5. In case no standard sensor is available at present, replace the internal temperature sensor by other sensor asides, and then check whether the error still exists; if the error disappears, replace the sensor; if the error still exists, check the main internal control panel and change if necessary.
<p>Special attention</p>	<p>Most internal temperature sensors of the frequency conversion machine have a resistance value of 15KΩ. Do not use improper sensor during repairing and maintenance, or it may led to the wrong temperature sensing of the machine, the start error or shutdown error. You can switch the air conditioner to the “Blowing” mode, and judge the accuracy of sensor though environmental temperature displayed on the screen. In case a sensor with the resistance value over 15KΩ is used, the detected temperature will be much lower than the actual temperature, which may lead to the shutdown error under heating mode, or the startup error under cooling mode. In case a sensor with the resistance value below 15KΩ is used, the detected temperature will be much higher than the actual temperature, which may lead to the startup error under heating mode, or the shutdown error under cooling mode.</p>

(2) E2 -external coil sensor error

Explanation of error	<p>Cause: The detection of short circuit or open circuit of external coil sensor during the inspection of main external control panel, indicated by “external coil sensor error”.</p> <p>Inspection path: Sensor→Sensor wire→Connectors→Main external control panel</p>
Tools required for inspection	Multimeter, 20KΩ standard sensor (25℃)
Frequent problematic part	External coil sensor, main external control panel
Inspection procedure and key points	<ol style="list-style-type: none">1. Check whether there’s resistance problem, short circuit or open circuit in the sensor; the resistance value shall with a reasonable range (about 20KΩ for frequency conversion machine)2. Check whether the sensor wire is broken.3. Check whether the terminal connectors are well fixed; check whether the weld between the terminal and the main control panel is loose, and pull the terminal slightly for inspection if necessary.4. Check whether the sensor is affected with damp. The coil sensor is quite easy to be affected with damp in case the lead of coil sensor is above the copper pipe.5. In case no standard sensor is available at present, replace the temperature sensor of external coil by other sensor asides, and then check whether the error still exists; if the error disappears, replace the sensor; if the error still exists, check the main internal control panel and change if necessary.
Special attention	<p>Most internal temperature sensors of the frequency conversion machine have a resistance value of 20KΩ.</p> <p>Do not use improper sensor during repairing and maintenance, or it may led to the start of protection mode due to wrong temperature sensing of the machine, or the protection error.</p> <p>In case a sensor with the resistance value over 20KΩ is used, the detected temperature will be much lower than the actual temperature, which may lead to the frequent entering of defrost mode, the illusory defrosting or the protection error during the cooling process.</p> <p>In case a sensor with the resistance value below 20KΩ is used, the detected temperature will be much higher than the actual temperature, which may lead to defrost error during the heating process, or the start of protection during the cooling process.</p>

(3) E3 -internal coil sensor error

<p>Explanation of error</p>	<p>Cause: The detection of short circuit or open circuit of internal coil sensor during the inspection of main internal control panel, indicated by “internal coil sensor error”. Inspection path: Sensor→Sensor wire→Connectors→Main internal control panel</p>
<p>Tools required for inspection</p>	<p>Multimeter,, 5KΩ or 20KΩ standard sensee (25℃)</p>
<p>Frequent problematic part</p>	<p>Internal temperature sensor, main internal control panel</p>
<p>Inspection procedure and key points</p>	<ol style="list-style-type: none"> 1. Check whether there’s resistance problem, short circuit or open circuit in the sensor; the resistance value shall with a reasonable range (about 20KΩ for frequency conversion machine) 2. Check whether the sensor wire is broken. 3. Check whether the terminal connectors are well fixed; check whether the weld between the terminal and the main control panel is loose., and pull the terminal slightly for inspection if necessary. 4. Check whether the sensor is affected with damp. The coil sensor is quite easy to be affected with damp in case the lead of coil sensor is above the copper pipe. 5. In case no standard sensor is available at present, replace the temperature sensor of internal coil by other sensor asides, and then check whether the error still exists; if the error disappears, replace the sensor; if the error still exists, check the main internal control panel and change if necessary.
<p>Special attention</p>	<p>Most internal temperature sensors of the frequency conversion machine have a resistance value of 20KΩ. Do not use improper sensor during repairing and maintenance, or it may led to the start of anti-frosting or overheat protection mode due to wrong temperature sensing of the machine. In case a sensor with the resistance value over 20KΩ is used, the detected temperature will be much lower than the actual temperature, which may lead to the high pressure of cold-blast protection system during the heating process, or the frequent start of anti-freezing protection during the cooling process. n case a sensor with the resistance value below 20KΩ is used, the detected temperature will be much higher than the actual temperature, which may lead to the frequent start of overheat protection mode during the heating or the overload protection during the cooling process.</p>

(4) E4 -Internal fan error of wall mounted air conditioner (PG motor)

<p>Explanation of error</p>	<p>Cause: PG motor is equipped with speed feedback signal line. When the feedback signal of speed is not received by the main internal control panel, it has no way to recognize the rotating speed of motor, which will be indicated as “Internal fan error”. Main causes for the disappearance of speed feedback signal are as follows: The fan is stucked; 2. The speed feedback component in the fan is broken; 3. Error of receiving circuit for the speed feedback signal from the main internal control panel.</p>
<p>Tools required for inspection</p>	<p>Multimeter, A PG motor in normal working condition</p>
<p>Frequent problematic part</p>	<p>Mechanical jam problem of internal fan, PG motor, main internal control panel</p>
<p>Inspection procedure and key points</p>	<ol style="list-style-type: none"> 1. Check whether the fan can work for a period of time before the error occurs. If yes, the reason of mechanical jam can be exclude. 2. Disconnect the power supply and move the fan blade of internal machine by hand to see if there’s any resistance. Some occasional internal fan error may relate to bearing coordination. 3. Reconnect the drive wire and speed feedback wire, thus to exclude any fan error due to connector loosening. 4. Check whether the plug-in terminal of speed feedback on the control panel is loose, and pull the terminal slightly for inspection if necessary. 5. Replace the motor in the faulted air conditioner with other PG motor (do not fix it with the fan for the time being), if the main control panel still indicates “internal fan error”, then replace the main internal control panel; if the error disappears, replace the internal fan.
<p>Special attention</p>	<p>The main internal control panel will not indicates “internal fan error” when the internal fan is still rotating; sometimes such error will not be reported when obvious fan problems exist (such as the low-speed rotation due to damaged fan capacitors, or non-uniform rotating speed due to abnormal speed feedback. Therefore, patience of the maintenance staff is required for the troubleshooting of fan error. You shall compare it with the normal condition, and detect and solve the problem in a flexible way.</p>

(5) E4- Internal fan error of wall mounted air conditioner (DC motor)

<p>Explanation of error</p>	<p>Cause: The internal fan of some highly energy efficient models is DC motor using a green plug through which the main internal control panel can drive the motor and sense the current rotational speed feedback. When the main internal control panel cannot receive the rotational speed feedback signal of the motor, it will indicate “DC motor error”. Disappearance of the rotational speed feedback signal may be caused by: 1 The motor is stuck and cannot work; 2 The speed feedback element inside the fan is destroyed; 3 There’s something wrong with the speed feedback signal receiving circuit of the main internal control panel. Inspection path: Is DC motor stuck by foreign matter→motor destroyed → Motor terminal connectors→Main internal control panel</p>
<p>Tools required for inspection</p>	<p>Multimeter, a DC motor in normal working condition</p>
<p>Frequent problematic part</p>	<p>Mechanical jam of internal fan, internal DC motor, main internal control panel</p>
<p>Inspection procedure and key points</p>	<ol style="list-style-type: none"> 1. Check whether the fan accelerates to extremely high speed before the error occurs. If it can work for a period, the reason of mechanical jam can be excluded. 2. Plug and unplug the terminal of the DC motor again to exclude any fan error due to connector loosening, and pull the terminal slightly for inspection if necessary. 3. Replace the motor in the faulted air conditioner with other DC motor to plug in the main internal control panel (do not fix it with the fan for the time being), if the main control panel still indicates “DC motor error”, then replace the main internal control panel; if the error disappears, replace the DC motor. 4. Multimeter can be used to distinguish whether it is main control panel problem or motor problem by: connect the motor with the main control panel and pay attention to the second (yellow) and fourth (black) wire from the outermost side among four lines of the terminal of the DC motor. After the air conditioner powers on in the cooling mode for a while, the voltage between the yellow and black wires should rise gradually and the motor should accelerates slowly, if the DC motor still won’t rotate, then the DC motor is destroyed.
<p>Special attention</p>	<p>Five lead wires division: Count from the outermost side of the four wires of the DC motor terminal, the first blue wire is the speed feedback wire with a voltage of 0.5-5V when the fan rotates; the second yellow wire is the motor driving wire with a voltage of 2.0-7.5V when the fan rotates; the second white wire is 15V power cord with a voltage of 15V in normal condition; the fourth black wire is 0V DC earth wire which is the benchmark of all the voltage tests; the fifth (red) wire is 310V wire which is strong with a voltage of 310V in normal condition, so be careful of electric shock.</p>

(6) E4- Sliding door error of floor standing

<p>Explanation of sliding door error</p>	<p>Cause: For the model with upper and lower sliding doors, the position of trap door is sensed via the upper and lower photoelectric switches. When the sliding door closes, it will move upward until the upper photoelectric switch senses the sliding door; when the sliding door opens, it will move downward until the lower photoelectric switch senses the sliding door. When the photoelectric switch cannot sense the position of the sliding door normally, it will indicate “sliding door error”.</p> <p>Inspection path: Mechanical jam of sliding plate → Synchronous motor → Can synchronous motor connect to 220V power → photoelectric switch connection wire → Photoelectric switch → Main internal control panel</p>
<p>Tools required for inspection</p>	<p>Multimeter, photoelectric switch in normal condition</p>
<p>Frequent problematic part</p>	<p>Mechanical jam of sliding plate, photoelectric switch, reversible synchronous motor, main internal control panel</p>
<p>Inspection procedure and key points</p>	<ol style="list-style-type: none"> 1. Power on and observe whether there is mechanical jam in the sliding plate. Note that new machines may be fixed by tapes, remove them. 2. If the sliding door slides normally when the machine powers on and off but it still indicates “sliding door error”, then there’s something wrong with the photoelectric switch. 3. If the sliding door does not slide when the machine powers on and off, check the reversible synchronous motor to see whether the motor is connected to 220V power or the motor’s wire is damaged. 4. If there is something wrong with the photoelectric switch, replace it with another one in normal condition and repeat the above procedures. If the error disappears, then it’s photoelectric problem; if not, then it’s main internal control panel problem.
<p>Special attention</p>	<ol style="list-style-type: none"> 1. Please confirm that it is a new sealed one when replacing the photoelectric switch. 2. There are two photoelectric switches, so check the upper one when the error occurs when powering off and check the lower one when the error occurs when powering on. 3. Terminals connected to upper and lower photoelectric switches should be connected accordingly because they have different colors. Otherwise, it will lead to reverse switches for the sliding plate.

(7) E5(5E) -Internal and external communication error

<p>Explanation of error</p>	<p>Cause: The frequency converter needs internal and external communication. When the communication cannot be reached, the internal and external units will indicate “internal and external communication error”. Only “main internal control panel, connecting cable and main external control panel” are related to communication; but sometimes the communication error will be indicated when the external unit has no power and the internal unit cannot connect with the external unit due to other errors, then such situation shall be distinguished from “pure communication error” and treated in a different way.</p> <p>Inspection path: Check if the external unit can power on and work (normally, the indicator light will turn off after lighting for several seconds, relay picks up, and PTC won’t heat seriously)</p> <p>1. Can power on and work: Are the internal unit and external unit matched→is the phase sequence of connecting wires of internal and external units correct (the live wire of the internal unit connects with that of the external unit, the null wire of the internal unit connects with that of the external unit)→Connecting wires touched well→Main internal control panel replacement→Main external control panel replacement</p> <p>2. Cannot power on and work: Can AC 220V be delivered to the terminal block of the external unit→Can the bridge rectifier and module panel generate DC 310V→Can the main external control panel generate a low voltage power supply of DC 5V→Does the main external control panel show the status of periodical reset.</p>
<p>Tools required for inspection</p>	<p>Multimeter, main internal control panel in normal condition</p>
<p>Frequent problematic part</p>	<p>Connecting wire phase sequence and contact, main internal control panel, main external control panel, module panel</p>
<p>Inspection procedure and key points</p>	<p>1. Firstly, the IDU and the ODU should be matched and connected properly.</p> <p>2. Observe the main external control panel, turn on the air conditioner, three lights are all lighted up then off and the relay pulls in. If not, it is power supply problem.</p> <p>3. Connect the black signal line S to terminal N of ODU. Turn on the A/C, if "E5" is still reported, the main external control panel need to be replaced. If "E5" is still reported at this time, go to step 4.</p> <p>4. Change a new main internal control panel, if the error code E5 remains, then the problem should be on the main external control panel.</p>

Special attention	When the external unit not power on: If the internal terminal board does not transmit 220V power, replace the main internal control panel; if the external terminal board has 220V power, first check if (fuse, reactor and bridge rectifier) are normal. There is still something wrong, replace the whole set of external control unit; for the control unit composed of several function boards, try disconnecting the weak-current data wires among several control boards and then power the external unit on, if the main control panel can be powered on and initialized successfully, then it's the module panel problems; if the main external control panel still cannot be powered on and initialized, replace the main external control panel.
--------------------------	---

(8) F0- External DC fan error (3-core terminal motor)

<p>Explanation of error</p>	<p>Cause: Our frequency changing external unit uses the 3-lead-wire DC motor, or “externally driven DC motor” for short, after 2012. It has no speed feedback circuit but 3 drive lead wires and its driving principle is similar to that of the compressor. The main control panel will indicate “external DC fan error” when it detects imbalanced current on the three lead wires of the driving motor. Inspection path: Is the DC fan stuck by foreign matters→Motor terminal connectors→Main external control panel→Motor</p>
<p>Tools required for inspection</p>	<p>Main external control panel in normal condition</p>
<p>Frequent problematic part</p>	<p>Mechanical jam of external fan, main external control panel, external DC motor</p>
<p>Inspection procedure and key points</p>	<ol style="list-style-type: none"> 1. First exclude the possibility of mechanical jam of external fan blades.。 2. Observe if the terminal of the fan is not connected firmly or the order of lead wires is correct. If the external fan of the newly installed air conditioner rotates reversely, first observe if the color order of the three lead wires is correct, or change the order of any two of the three lead wires of the motor to see if the fan can rotate in the forward direction. 3. The DC motor of this scheme is relatively simple and reliable, so the problem is more likely to be caused by the drive part of the fan of the main external control panel. The maintenance personnel may as well prepare matched main external control panel before maintenance. If the fan returns to normal after replacing the main control panel, then it’s the main control panel problem; if it still indicates external DC motor error, then replace the external DC motor.
<p>Special attention</p>	<p>Unlike the 5-core internal DC motor, there will be a process of fan blade position locking before the 3-core DC motor with external drive starts to rotate. The fan blades will shake mechanically for 3-5 seconds and then rotate slowly, which is normal phenomenon.</p>

(9) F1 -Module protection error

<p>Explanation of error</p>	<p>Cause: The power module is the part to directly drive the compressor to work. It can protect the machine in time when overcurrent, overvoltage or overheat occurs and stops the compressor from working. It will, at the same time, send “shutdown request” to the module panel. The error triggered by the “shutdown request” is called “module protection error”. Inspection path: Supply voltage → Compressor wire, reactor wire → System blocked → Module panel damaged → Main external control panel destroyed → Compressor destroyed</p>
------------------------------------	--

Tools required for inspection	Multimeter, pressure gauge, megameter, module panel in normal condition
Frequent problematic part	Supply voltage, compressor wire, reactor, system pressure, module panel, main external control panel, compressor
Inspection procedure and key points	<ol style="list-style-type: none"> 1. Is the order of compressor wires not correct, which makes the compressor rotate reversely? Try exchanging the compressor wires on U-V phase to see if the problem can be solved? 2. Check if the supply voltage is unstable and highly volatile, and test if the system pressure is normal. High system pressure will cause rotating problems to the compressor. 3. Is the module panel fixed to the radiator firmly? Will it cause pool cooling? Is the internal and external heat exchanger dirty, which lead to poor heat transfer and high system pressure? 4. If “module protection error” will be indicated immediately after starting up, it is almost certain that it’s substantial error, having nothing to do with supply voltage and system pressure, it is suggested to observe if there is any component destroyed by strike arc near the module panel; use the multimeter to test if the resistances between any two compressor wires are the same. The resistances between any two compressor wires in normal condition are tiny resistances at ohm level and are basically equal; then use the megameter to measure if the resistance insulation of the three compressor wires against the earth wire is good (normally at MΩ level), and check if the reactor wire is well connected or the reactor is destroyed. 5. Test if the 15V and 5V (3.3V) power supply on the module panel is stable and exclude the module panel error caused by power supply of the main external control panel. 6. Methods for judging whether the power module is damaged: use the “diode position” of the multimeter to measure the features of P of the module panel against U-V-W three phases respectively. Measure the power module P-U, P-V and P-W, there is always infinite resistance at one side and fixed on-state voltage at the other side (generally 0.5V); measure the features between N-U, N-V and N-W in the same way, if short circuit occurs during any measurement, then the module is destroyed. 7. Replace with the module panel in normal condition for test. If the test is normal after changing the module panel, then the original module panel is destroyed. 8. After excluding problems of module, connecting wires, system and power supply, distinguish by ear. If there is only electromagnetic sound and the compressor does not work; or the sound of irregular running appears after the compressor works for a while and then it shuts down and indicates error; chances are that the compressor is blocked or destroyed, consider replacing the compressor.

(10) F2- PFC protection error

Explanation of error	<p>Cause: PFC board is a component of the inverter air conditioner for power factor correction and voltage boosting. When the PFC board cannot perform power calibration as normal because of overcurrent and overvoltage, it will indicate “PFC protection error” and its function may also be integrated with the module panel or main control panel.</p> <p>Inspection path: Supply voltage→AC and DC power path→PFC board data wire→PFC board→Main control panel</p>
Tools required for inspection	Multimeter, PFC board in normal condition
Frequent problematic part	Supply voltage, reactor, PFC board, module panel, main external control panel
Inspection procedure and key points	<ol style="list-style-type: none">1. Check if the supply voltage is unstable and highly volatile or the voltage is too low (below AC 135V)2. The reactor is one of core parts of PFC. Check if the reactor itself is destroyed and the reactor connecting wire is in poor connection, which makes PFC functions not performed. Do not remove the reactor and replace with short circuit by no means.3. If “PFC protection error” will be indicated immediately after starting up, it is almost certain that it’s substantial error, having nothing to do with supply voltage, it is suggested to observe if there is any component destroyed by strike arc near the module panel4. Test if the 15V and 5V (3.3V) power supply on the PFC board is stable and exclude the PFC board error caused by power supply of the main external control panel.5. Replace with the PFC board in normal condition for test. If the test is normal after changing the PFC board, then the original PFC board is destroyed.6. The possibility that there is something wrong with 15V or 5V power of the module panel that causes the control power supply problem of the PFC board is not excluded.7. Some module panels integrate PFC function and compressor drive function in one, so just replace with an integrated module panel.8. For single-panel single-chip main control panels, if PFC protection error appears, and there is no problem in supply voltage, reactor connection or reactor, just replace the controller of the external unit.

(11) F3- Compressor out-of-step error

<p>Explanation of error</p>	<p>Cause: The module panel will constantly test the current of lead wires of the compressor and calculate the position of the rotator of the compressor when driving the compressor to work. When the compressor deviates far from the normal operating status, it will indicate “compressor out-of-step error” because the current of the compressor wires is too high or it cannot detect the position of the rotator. This error always follows “module protection error”, so they have similar inspection methods.</p> <p>Inspection path: supply voltage→Compressor wire, reactor wire→System blocked→Module panel damaged→Main external control panel destroyed→Compressor destroyed</p>
<p>Tools required for inspection</p>	<p>Multimeter, pressure gauge, module panel in normal condition</p>
<p>Frequent problematic part</p>	<p>Supply voltage, compressor wire, reactor, system pressure, module panel, main external control panel, compressor</p>
<p>Inspection procedure and key points</p>	<ol style="list-style-type: none"> 1. Is the order of compressor wires not correct, which makes the compressor rotate reversely? Try exchanging the compressor wires on U-V phase to see if the problem can be solved? 2. Check if the supply voltage is unstable and highly volatile, and test if the system pressure is normal. High system pressure will cause rotating problems to the compressor. 3. Is the module panel fixed to the radiator firmly? Will it cause pool cooling? Is the internal and external heat exchanger dirty, which lead to poor heat transfer and high system pressure? 4. If “compressor out-of-step error” will be indicated immediately after starting up, it is almost certain that it’s substantial error, having nothing to do with supply voltage and system pressure, it is suggested to observe if there is any component destroyed by strike arc near the module panel; use the multimeter to test if the resistances between any two compressor wires are the same. The resistances between any two compressor wires in normal condition are tiny resistances at ohm level and are basically equal; then use the megameter to measure if the resistance insulation of the three compressor wires against the earth wire is good (normally at MΩ level), and check if the reactor wire is well connected or the reactor is destroyed. Check if the DC voltage between P-N is too high (above 200V). 5. Test if the 15V and 5V (3.3V) power supply on the module panel is stable and exclude the module panel error caused by power supply of the main external control panel. 6. Replace with the module panel in normal condition for test. If the test is normal after changing the module panel, then the original module panel is destroyed. 7. After excluding problems of module, connecting wires, system and power supply, distinguish by ear. If there is only electromagnetic sound and the compressor does not work; or the sound of irregular running appears after the compressor works for a while and then it shuts down and indicates error; chances are that the compressor is blocked or destroyed, consider replacing the compressor.

Special attention	For the “compressor out-of-step error” and “module protection error”, the former is calculated by the main chip of the module panel and the latter is detected by the power module itself. They are abnormal operating phenomenon of the compressor essentially. If there is uncertainty about either error, analyze both together with similar method. For inverter air conditioners that are in poor electrical environment or are old, occasional occurrence of such errors is a normal protection.
--------------------------	--

(12) F4- Exhaust sensor error

Explanation of error	<p>Cause: The main external control panel will indicate “exhaust sensor error” and send it to the main internal control panel when it detects short circuit or open circuit of the exhaust sensor.</p> <p>Inspection path: Exhaust sensor→Sensor wire→Connectors→Main external control panel</p>
Tools required for inspection	Multimeter, 50KΩ standard exhaust sensor (25℃)
Frequent problematic part	Exhaust sensor, main external control panel
Inspection procedure and key points	<ol style="list-style-type: none"> 1. Check if there is any evident resistance problem in the sensor. Whether in short circuit or open circuit, the resistance should maintain in a reasonable range (about 50KΩ when the compressor is not working and between 3 KΩ and 30 KΩ after the compressor works for a while, the corresponding exhaust temperature should be 100℃ -38℃). 2. Check if the sensor wire or the sensor connecting wire is damaged. 3. Check if the connecting terminal is connected firmly, the weld between the terminal and the main control panel is loose; pull the terminal slightly for inspection if necessary. 4. Check whether the sensor is affected with damp. The coil sensor is quite easy to be affected with damp in case the lead wire of coil sensor is above the copper pipe. 5. If there is no standard sensor at hand, exchange the exhaust sensor with the one beside it to see if the error changes. If yes, there is something wrong with the sensor and it should be replaced; if it still indicates “external coil sensor error”, replace the main external control panel.
Special attention	Most exhaust sensors have a standard resistance of 50KΩ (25℃). Do not use improper sensor during maintenance, or the machine will sense the exhaust temperature mistakenly and enters the protection state frequently. For example, in the case where replace the 20KΩ coil sensor for the exhaust sensor by mistake, the exhaust temperature that the main external control panel senses will be higher than the actual exhaust temperature, which will make normal air conditioners enter the high exhaust temperature protection state frequently, and the compressor frequency threshold will rise and lead to shutdown of the compressor.

(13) F5 -Compressor top head sensor error

Explanation of error	<p>Cause: The compressor top head sensor is a compressor top head temperature protection switch most of the time. It keeps closed (short circuit) when the compressor temperature is normal and switches off (open circuit) when the temperature is too high. The main external control panel will indicate “compressor top head sensor error” when it senses disconnection of the compressor top head protection switch.</p> <p>Inspection path: Compressor top head sensor (temperature protection switch)→Sensor wire→Connectors→Main external control panel</p>
Tools required for inspection	Pressure gauge, multimeter
Frequent problematic part	System pressure, liquid deficiency, compressor top head sensor (temperature protection switch), main external control panel
Inspection procedure and key points	<ol style="list-style-type: none"> 1. First check if the compressor top head temperature is too high (above 110°C) and causes action of the compressor top head sensor (temperature protection switch); reasons why the compressor top head temperature is too high may be: the system is deficient in liquid and the compressor idles; the system is blocked and the pressure of the compressor is too high. 2. After excluding the possibility of the system problem, please note that the temperature protection switch is closed normally. Test if the terminals of the sensor are in the short-circuit condition with the multimeter. In the case of open circuit, then there is something wrong with the sensor or lead wires. 3. Check if the sensor wire or the sensor connecting wire is damaged. 4. Check if the connecting terminal is connected firmly, the weld between the terminal and the main control panel is loose; pull the terminal slightly for inspection if necessary. 5. Disconnect the power supply and short circuit a metal with the compressor top head terminal of the main external control panel. If the compressor top head sensor error disappears after start up, then replace the sensor; if the error still occurs, it’s probably the main control panel problem, replace the main external control panel.
Special attention	The compressor top head sensor is just a temperature switch which is highly reliable and is less likely to go wrong generally. Pay more attention to the system pressure and the compressor temperature.

(14) F6- external temperature sensor error

Explanation of error	<p>Cause: The detection of short circuit or open circuit of external temperature sensor during the inspection of main external control panel, indicated by "external temperature sensor error".</p> <p>Inspection path: Sensor→Sensor wire→Connectors→Main external control panel</p>
Tools required for inspection	Multimeter, 15K Ω standard sensor (25 $^{\circ}$ C)
Frequent problematic part	External temperature sensor, main external control panel.
Inspection procedure and key points	<ol style="list-style-type: none">1. Check whether there's resistance problem, short circuit or open circuit in the sensor; the resistance value shall be within a reasonable range (15KΩ under the temperature of 25$^{\circ}$C).2. Check whether the sensor wire is broken.3. Check whether the terminal connectors are well fixed; check whether the weld between the terminal and the main control panel is loose, and pull the terminal slightly for inspection if necessary.4. Check whether the sensor is affected with damp.5. In case no standard sensor is available at present, replace the external temperature sensor with the other sensor asides, and then check whether the error still exists; if the error disappears, replace the sensor; if the error still exists, it's possible that the main control panel is faulted, change the main external control panel.
Special attention	Most of the standard resistance values of the external temperature sensors are 15K Ω (hen temeprature is at 25 $^{\circ}$ C), and the higher the temeprautre is, the lower the resistance value is, and the lower the temperature is, the higher the resistance value is. Do not use improper sensor during repairing and maintenance, or it may led to the wrong temperature sensing of the machine.

(15) F7-OVP or UVP error

<p>Explanation of error</p>	<p>Cause: All the inverter air conditioners are equipped with voltage inspection circuits, but different models of machines have different locations for the voltage inspection (on the module panel or main external control panel). When the supply voltage is lower than 135V or higher than 275V, the inspection circuit would detect over or under voltage protection signal and send it to the main external control panel and the main external control panel would raise the alarm "OVP or UVP error" and indicate it through the internal motor. Inspection path: supply voltage → internal direct current voltage → reactor wiring → module panel → main external control panel.</p>
<p>Tools required for inspection</p>	<p>Multimeter</p>
<p>Frequent problematic part</p>	<p>Supply voltage, reactor, module panel and main external control panel.</p>
<p>Inspection procedure and key points</p>	<ol style="list-style-type: none"> 1. First, check the supply environment of the user, especially shall check when the compressor of the air conditioner has been running for a while. The normal supply voltage shall be between 198V and 242V and the minimum work assurance range of the air conditioner shall be within 165V and 265V and it shall be especially noted that the voltage value shall not be decreased significantly after running of the compressor (voltage decreasing by over 25V), because if the supply voltage is decreased by a lot, it means the supply line capacity is insufficient and the user is usually suggested to replace the circuit or install a specialized air conditioner supply voltage stabilizer. 2. For the external machines with PFC panels (without separate rectifier bridges), the operator shall ensure if the PFC function is on with the direct current voltage grade of the multimeter. When the compressor is running, voltage between P and N ends detected on the test module panel or main external control panel shall be over 200V and if the voltage is below that range, it is possible that the reactor is faulted or the PFC is broken. 3. When the air conditioner is switched on, if the compressor is not running but there is an alarm of "OVP or UVP error" and the power voltage detected with the multimeter is not below 150V, it's probably the voltage inspection circuit is faulted. The operator shall check and confirm the voltage inspection circuit is on which control panel first and then replace it. The regular replacement: for the external machine of single panel single chip, replace the external controller directly; and for the machine of two panels, replace the module panel.
<p>Special attention</p>	<p>For some models, OVP or UVP error signal is delivered through the connector wires between the module panel and the main external control panel, thus it is possible the voltage signal is not delivered when the communication between the module panel and the main external control panel is not good. It is possible that the error is false raised but after some minutes that the error is finally confirmed as "Main external control panel and module panel communication error", which shall be specially noted.</p>

**(16) F8-main external control panel and module panel communication error
(exclusive of external machine of single panel)**

Explanation of error	<p>Cause: Only the models with the module panels separated with the main external control panels may have this error. When the machine is running normally, the module panel and the main external control panel would coordinate with each other on the communication to work and when the communication is off, the main external control panel would raise the alarm of "main control panel and module panel communication error". Only "module panel, data line and main external control panel" are related to such communication.</p> <p>Inspection path: data line connection → module panel power →module panel →main external control panel</p>
Tools required for inspection	Multimeter and regular module panel.
Frequent problematic part	Module panel and main control data line, module panel and main external control panel.
Inspection procedure and key points	<ol style="list-style-type: none"> 1. First check if the communication connection line (mostly 4 chips) between the module panel and main control panel gets loose and if the connection is faulted. 2. Measure and check with a multimeter if the power from the main external control panel is normal and especially note that if the 5V (3.3V) power is led to the module panel. Eliminate the possibility that it's not running normally because there is no 5V (3.3V) power at the module panel. 3. The maintenance personnel shall replace the module panel of the faulted air conditioner with a regular module panel taken with him and if the communication error disappears when the external machine is switched on, it means the original module panel is faulted and if the error is still there, maybe the main external control panel shall be replaced.

(17) F9- outdoor EE error

Explanation of error	<p>Cause: Many parameters need to be preset for the running of the external unit of the air conditioner and such parameters are placed in a data storage 8-foot chip, which is called "EEPROM" or "EE" for short. The motor on the main external control panel can only work after reading the data stored in EE and if not read, the alarm "outdoor EE error" would be reported and raised in the internal machine. Reasons for data not being read are as follows:</p> <ol style="list-style-type: none"> 1. wrong EE chip data format; 2. EE chip is broken; 3. bad contact of EE or fault of EE reading circuit; 4. backward installation of EE chip. <p>Inspection path: main external control panel.</p>
Tools required for inspection	None.
Frequent problematic part	Bad contact of EE, main external control panel.

Inspection procedure and key points	1. Replace the main external control panel directly.
--	--

(18) FA- recirculated sensor error (only models of electronic expansion valves are involved)

Explanation of error	<p>Cause: The recirculated sensors are only used on machine models of electronic expansion valves and the back temperature value is considered as the basis for adjustment of the electronic expansion valve and determination if the four-way valve changes the position normally during heating. When the main control panel detects open circuit or short circuit of the recirculated sensor, it would raise an alarm of "recirculated sensor error" and send it to the main internal control panel to indicate it.</p> <p>Inspection path: four-way valve → recirculated sensor → sensor wire → connectors → main external control panel</p>
Tools required for inspection	Multimeter, pressure meter, normal 20KΩ recirculated sensor
Frequent problematic part	Four-way valve, recirculated sensor, main external control panel.
Inspection procedure and key points	<ol style="list-style-type: none"> 1. If the error appears in heating but not in cooling, first check if the four-way valve failed to change the position or there is a back flow, which can be estimated by measuring the high and low pressures with the pressure meter; for the consideration of electricity control, we can use a multimeter. During heating, check if the four-way valve terminal can switch a circuit of 220V, if yes and the four-way valve still is faulted in the position changing, the four-way valve is faulted; and if there is no circuit over 220V in heating, it means the main external control valve is faulted. 2. If it is not the four-way valve that is faulted, check on the resistance value and short circuit problems and the resistance value shall be within a proper range (around 20KΩ at temperature of 25°C). 3. Check whether the terminal connectors are well fixed; check whether the weld between the terminal and the main control panel is loose, and pull the terminal slightly for inspection if necessary. 4. Check whether the sensor is affected with damp. For the recirculated sensor, if the led is on the above and the copper pipe is below, it is possible to be damped. 5. The maintenance personnel can replace the possibly faulted recirculated sensor with a normal one and if the error disappears, it means the original recirculated sensor is faulted and needs to be replaced; and if the error is still there, consider to replace the main external control panel.

(19) Function protection prompt of frequency conversion external machine

<p>Explanation of error</p>	<p>Cause: In the regular running of the air conditioner, for some nonfaulted status, it may need the compressor to shut down or limit or lower the frequency so as to protect the normal operating of the entire cooling system (eg. defrosting, slight undercooling, over pressure, overcurrent, etc.). These problems are not considered as errors and would not be reflected in the internal machine, however as to make sure the maintenance personnel is familiar with the running status of the air conditioner, three indicator lights are used on the main external control panel for reference of the maintenance personnel.</p> <p>Including: over current protection, cooling overload protection, indoor heating high temperature protection, indoor cooling freezing protection, over pressure and under pressure protection.</p>
<p>Tools required for inspection</p>	<p>Multimeter.</p>
<p>Frequent problematic part</p>	<p>Regular protection, system blockage, power supply not as usual, resistance value of sensor drifts or is used wrong.</p>
<p>Inspection procedure and key points</p>	<ol style="list-style-type: none"> 1. Defrosting: with a defrosting signal, meaning the air conditioner is under defrosting procedure and it is normal, but if there is frequent defrosting, it shall be specifically noted if heat exchange of the external unit is faulted, if the fan revolving speed is low and if the resistance value of the coil sensor is drifted or the temperature is inaccurately measured or it is damaged. 2. Over current protection: it is more possible to appear under high temperature cooling status and the over current of compressor is usually reflected by over high load of the compressor. It is normal if such protection appears under a very high temperature cooling status but not under low temperature low load status. 3. Cooling overload protection: it is more possible when the frequency conversion machine is under a high temperature cooling status. When the outdoor coil sensor senses the temperature is too high, as to prevent the compressor from overload, it would positively lower the frequency and it is normal for the protection under the high temperature cooling status. 4. Indoor high temperature heating protection: it is more possible when the frequency conversion machine is under a high temperature heating status. When the indoor coil sensor senses the temperature is too high, as to prevent the compressor from overload, it would positively lower the frequency and it is normal for the protection in a warm room. 5. Indoor cooling freezing protection: it is more possible to appear under a low temperature cooling status. When the indoor coil sensor senses the temperature is too low, as to prevent the heat exchanger of the internal machine from frosting, it would positively lower the frequency and it is normal for the protection in a low temperature room.

	<p>6. Over or under pressure protection: this protection is a pilot protection for the "over or under pressure error". When the power pressure is too high or too low but not so high or so low to reach limit for shutting down (within 165V-265V), it would limit and lower the frequency first to reduce the air conditioner's needs for the power to keep teh air conditioner running. This protection is for the adaption to a unstable power environment and when there is such protection prompt, it usually means it is possible for "OVP and UVP error" and the maintenance personnel shall especially note.</p> <p>7. Cooling overload protection, indoor high temperature heating protection and indoor coolign freezing protection are also possible related to the drift of the resistance value of the sensor.</p>
--	--

3-2 Common Parameters

1. Display error code of indoor unit: Frequency conversion air conditioners only involve E1, E2, E3 and E4

No.	Error Code	Error Name	Probable Trouble Location
1	E1	Internal room temperature sensor error	Internal room temperature sensor, main internal control panel
2	E2	External coil sensor error	External coil sensor error, main external control panel
3	E3	Internal coil sensor error	Internal coil sensor error, main internal control panel
4	E4	Indoor fan error	Mechanical jam of internal fan blade, internal fan, main internal control panel
5	E5(5E)	Indoor and outdoor unit communication error	Bridge cable, main internal control panel, main external control panel, module panel
6	F0	Outdoor DC fan error	Mechanical jam of external fan, external DC fan, main external control panel
7	F1	Module protection error	Power voltage, compressor cable, reactor, module panel, main external control panel, compressor
8	F2	PFC protection error	Power voltage, reactor, module panel, main external control panel
9	F3	Compressor out-of-step error	System pressure, compressor cable, module panel, main external control panel, compressor
10	F4	Exhaust air sensor error	Exhaust air sensor, main external control panel
11	F5	Compressor cap sensor error	System pressure, compressor cap sensor (protection switch), main external control panel
12	F6	External room temperature sensor error	External room temperature sensor, main external control panel
13	F7	OVP or UVP error	Power voltage, reactor, module panel, main external control panel
14	F8	Main external control panel and module panel communication error	Connection wire of module and main control data, module panel, main external control panel
15	F9	Outdoor EE error	Main external control panel
16	FA	Recirculated sensor error	Recirculated sensor, four-way valve, main external control panel

2. Display error code of outdoor unit's indicator lights:

Display by the 3 LED indicator lights on the control panel of the outdoor unit:

○ for off; ● for on; ★ for flashing.

No.	LE D1	LE D2	LE D3	Error Name	Probable Trouble Location
1	○	○	○	Normal (outdoor unit standby)	Normal, all three lights off for standby status.
2	★	★	★	Normal (compressor running)	Normal, all three lights flash while compressor running.
3	●	●	●	Forced service (test mode)	Normal
4	★	★	●	Module protection error	Power voltage, compressor cable, reactor, module panel, main external control panel, compressor.
5	★	★	○	PFC protection error	Power voltage, reactor, module panel, main external control panel.
6	★	●	★	Compressor out-of-step error	Power voltage, compressor cable, module panel, main external control panel, compressor.
7	★	○	★	Exhaust air sensor error	System pressure, exhaust air sensor, main external control panel.
8	●	★	★	External coil sensor error	External coil sensor, main external control panel.
9	○	★	★	External room temperature sensor error	External room temperature sensor, main external control panel.
10	★	●	●	Indoor and outdoor unit communication error	Connection wire, main internal control panel, main external control panel, EE reverse connection, module panel.
11	★	●	○	Main external control panel and module panel communication error	Connection wire of module and main control data, module panel, main external control panel
12	★	○	●	Outdoor EE error	Main external control panel
13	★	○	○	Outdoor DC fan error	Mechanical jam of external fan, external DC fan, main external control panel.
14	●	★	●	Internal room temperature sensor error	Internal room temperature sensor, main internal control panel.

15	●	★	○	Internal coil sensor error	Internal coil sensor, main internal control panel.
16	○	★	●	Indoor fan error	Mechanical jam of fan, internal fan, main internal control panel.
17	○	★	○	Refer to tooling display for other errors	Entire set of external controller.
18	●	●	★	Compressor cap sensor error	System pressure, compressor cap sensor (protection switch), main external control panel.
19	●	○	★	Recirculated sensor error	Recirculated sensor, four-way valve switch error, main external control panel.
20	○	●	★	※ Compressor overpower protection	Power voltage, module panel, main external control panel.
21	○	○	★	※ Over current protection	Power voltage, system pressure, module panel, main external control panel.
22	●	●	○	Exhaust sensor error	System pressure, exhaust sensor, main external control panel.
23	●	○	●	※ Cooling overload protection	Condenser, external fan, capillary, external coil sensor, main external control panel.
24	○	●	●	※ Indoor high temperature heating protection	Evaporator, internal fan, thin unit connection pipe, internal coil sensor, main internal control panel.
25	●	○	○	※ Indoor cooling freezing protection	Evaporator, internal fan, capillary, internal coil sensor, main internal control panel.
26	○	●	○	Compressor shell temperature protection	Same as "18 Compressor cap sensor error".
27	○	○	●	※ OVP or UPV error	Power voltage, reactor, module panel, main external control panel.

3-3 Troubleshooting for Normal Malfunction

➤ The Foremost Inspecting Items

- ① The input voltage must be within +10% tolerance of the rated Voltage. If it is not the case, the air-conditioner will probably not work normally.
- ② Check the connecting cord between indoor unit and outdoor unit to see if it is properly connected. The connecting must be done according to the wiring diagram, please also notice that even different models may have the connecting cord of the

same specification. Please check if the marks at the connecting terminal and the marks on the cord can match, otherwise, the air-conditioner will not work normally.

③ If the following phenomena are found, the problem is not from the air-conditioner itself.

NO.	Problems	Causes
1	The motor is heard operating but the air-conditioner does not work when the indoor unit is powered on	Since the air-conditioner is powered on, it will come to working condition as long as you press the ON/OFF button of the remote control and the Signal is well received.
2	The compressor stops running but the indoor fan motor keeps working when it is at cooling mode with the indoor temperature higher than set temperature.	If you turn off the air-conditioner and restart it immediately, it will return to normal in 3 minutes, after that, the air-conditioner will automatically adjust the indoor fan speed to what you set.
3	The compressor works discontinuously at dehumidifying mode.	The air-conditioner will automatically control the working of the compressor according to the inside temperature.
4	The air-conditioner does not work while the LED display is on.	The TIMER is set with the A/C; it will be in hold on condition. If the TIMER setting is cancelled, the air-conditioner will return to normal working condition.
5	The compressor works discontinuously at cooling and dehumidifying mode, and the indoor fan motor slows down.	The compressor stops internally or the fan motor slows down to prevent the indoor heat exchanger from being frozen.

➤ **Fault Diagnosis by Symptom**

① No Power Display

(1) Items

- Check if the input voltage is correct?
- Check if the AC power supply connecting is correct?
- Check if the output voltage of the manostat L7805 (IC2) is correct?

(2) Trouble shooting procedure

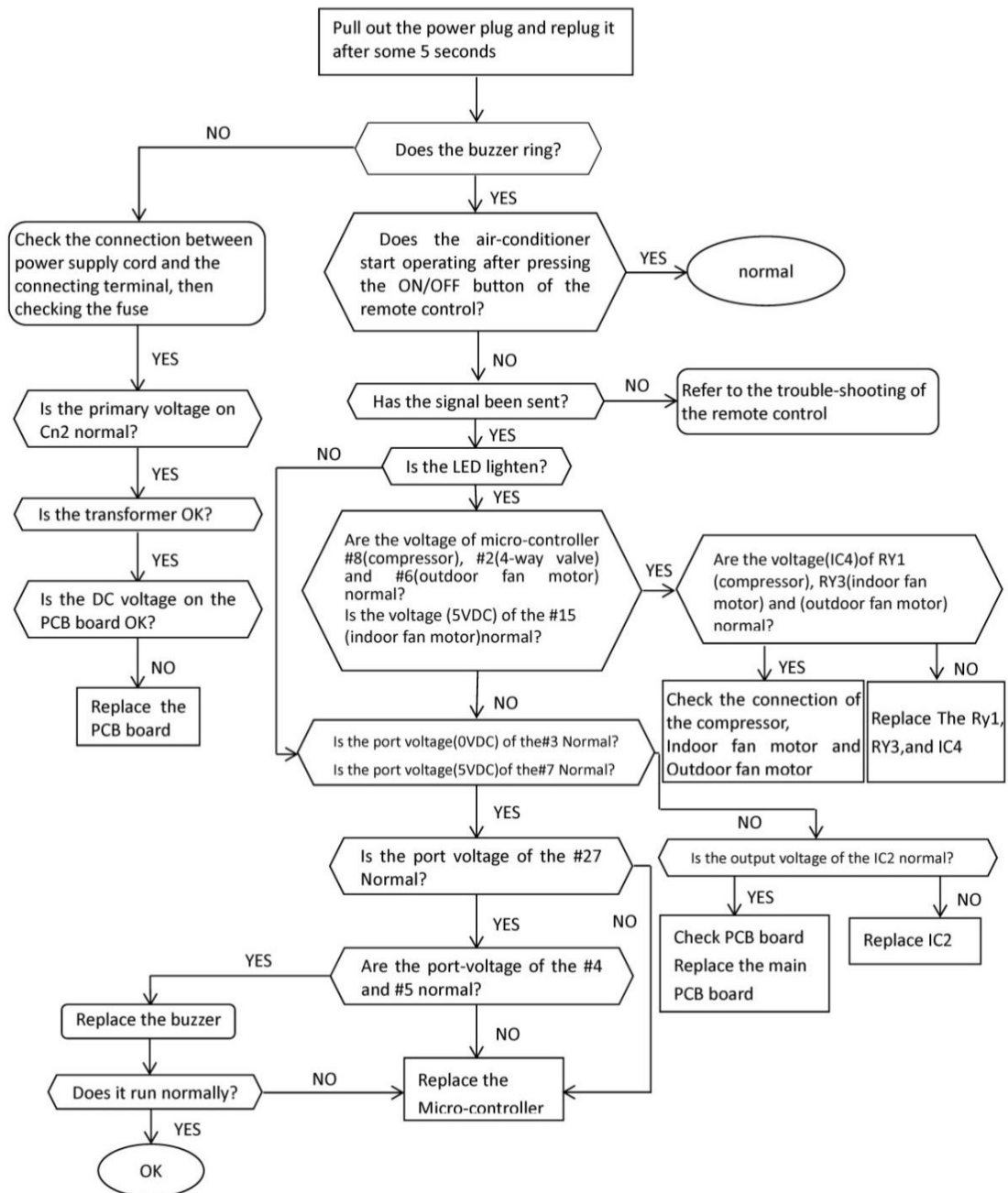

② The Indoor Fan Motor Does Not Work

(1) Items

a) Check if the indoor fan motor is connected correctly to the connector (CN8)?

b) Check if the AC input voltage is correct?

c) Check if the IC of indoor fan motor is connected correctly to the connector (CN2)?

d) Check if the capacity of indoor fan motor is connected correctly to the connector (CN8)?

(2) Trouble shooting procedure

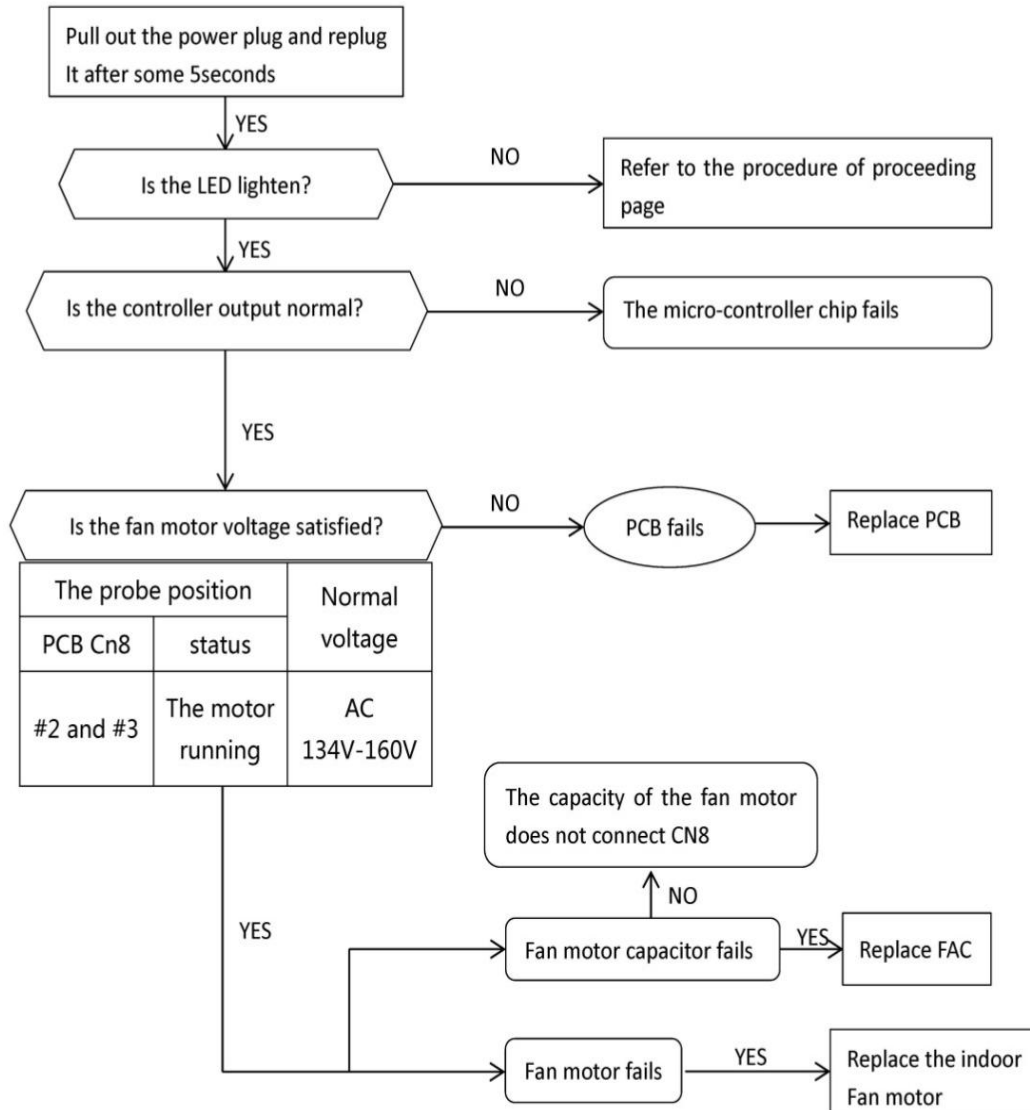

③The Outdoor Unit Does Not Work

(1) Items

- a) Check if the input voltage is correct?
- b) Check if the wire connection of the outdoor connecting terminal is correct?

(2) Trouble shooting procedure

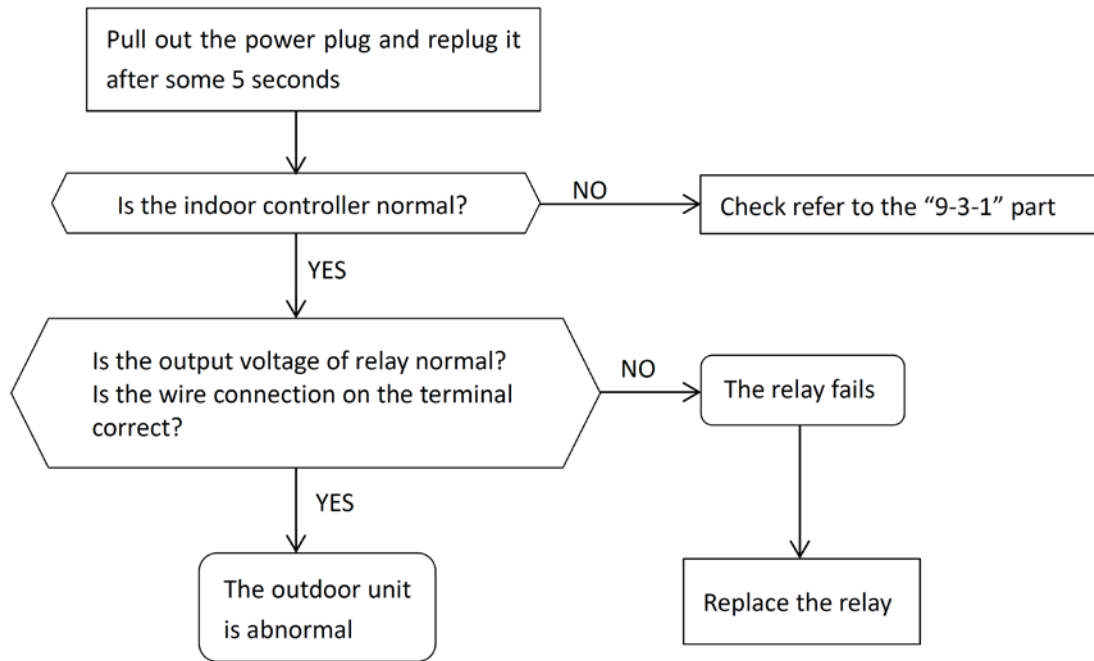

④The Step Motor Does Not Work

(1) Items

a) Check if the input voltage is correct?

b) Check if the step motor controlling the up-down movement firmly connected to Cn2?

(2) Trouble shooting procedure

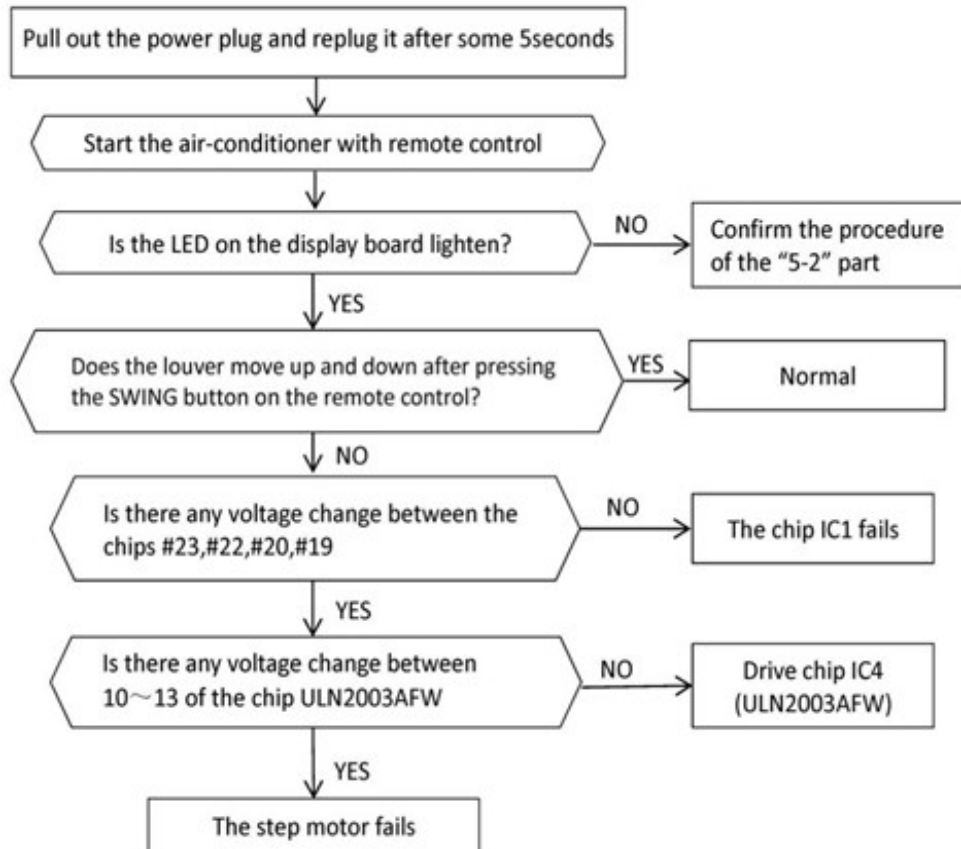

⑤ Heating Mode Can Work, But No Hot Air Blow

- (1) Check if the set temperature is lower than the indoor temperature?
- (2) Check if the indoor PCB is connected to the terminal correctly?

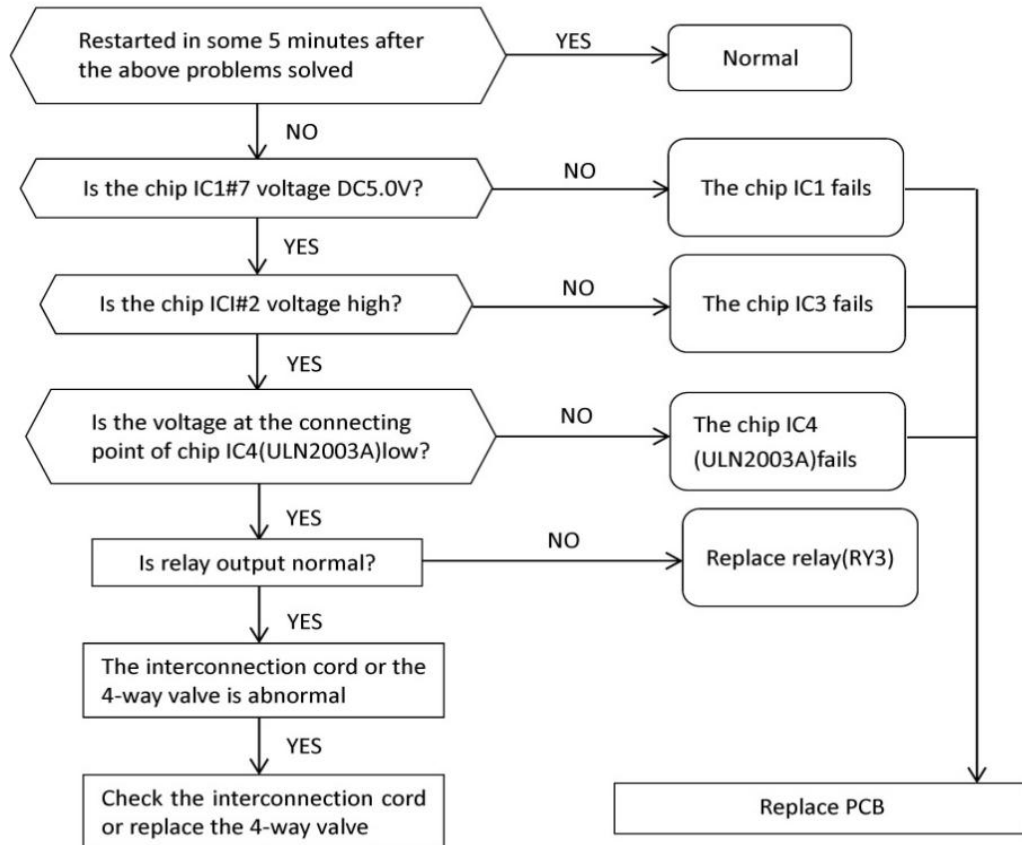

⑥ Remote Control Can Not Work

Trouble shooting procedure

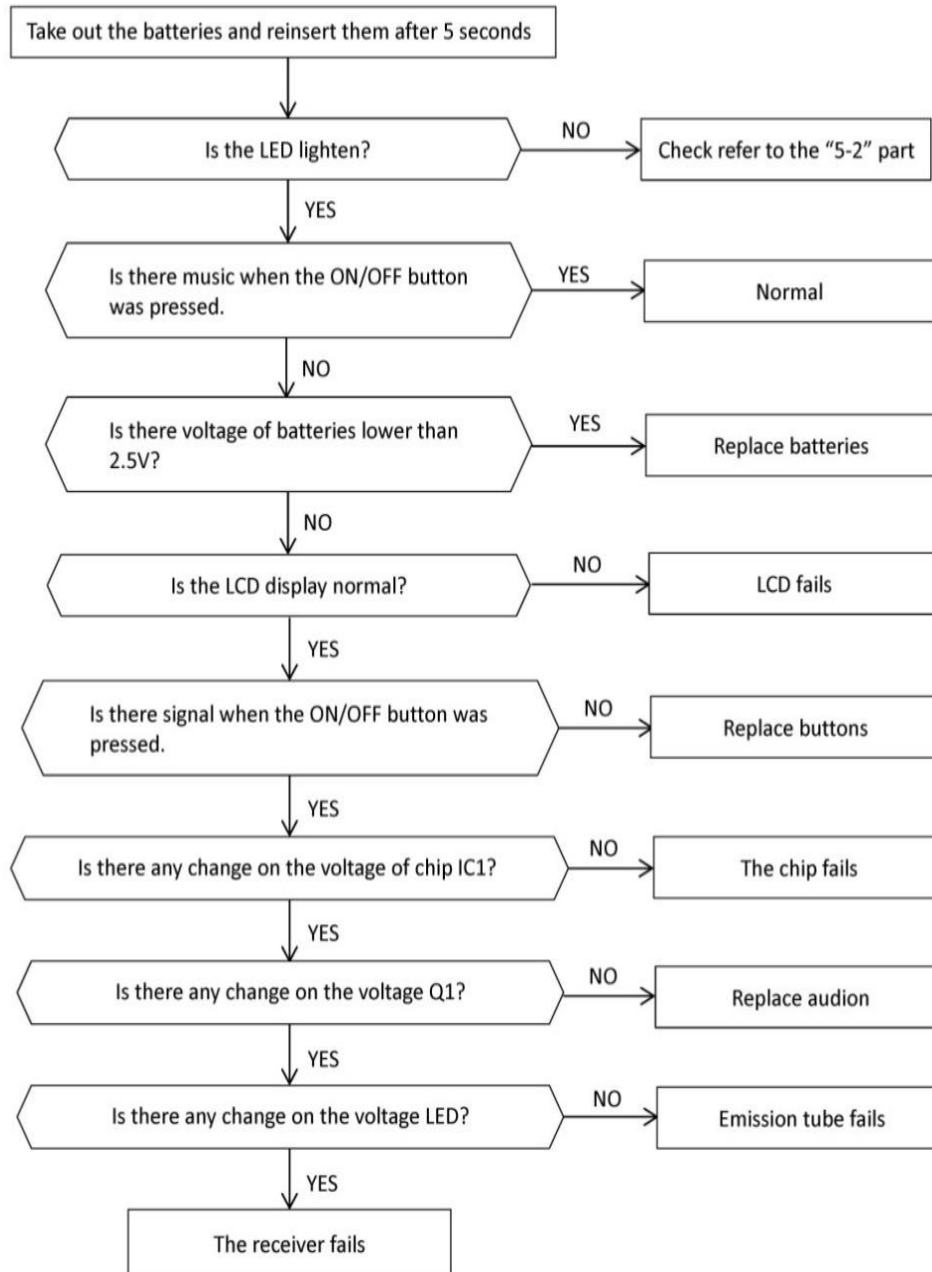



4. Removal Procedure

Stop operation of the air conditioner and remove the power cord before repairing the unit.

4-1 Indoor Unit

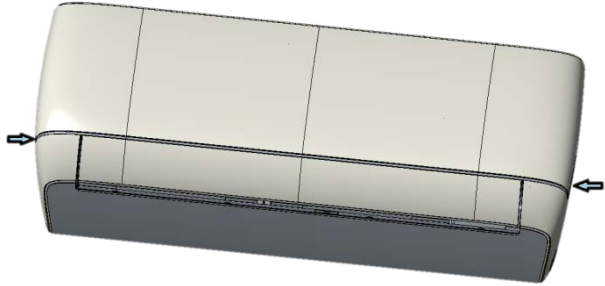
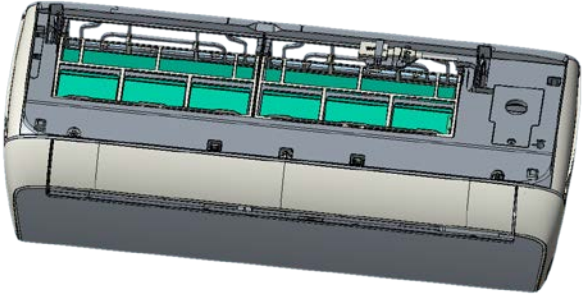
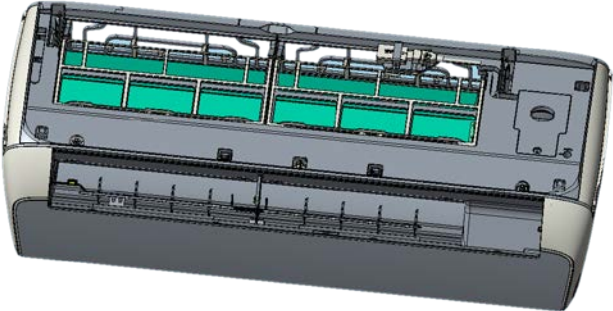
➤ 26J

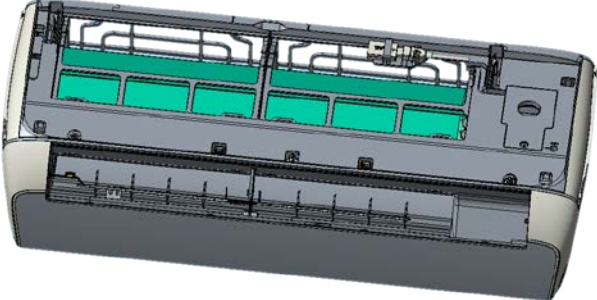
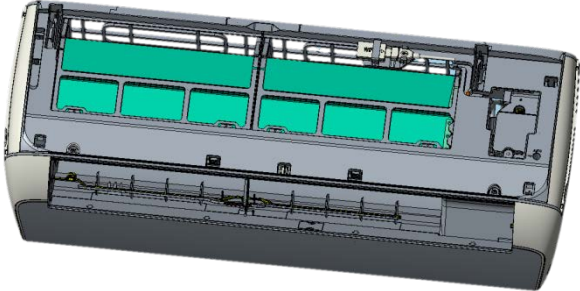
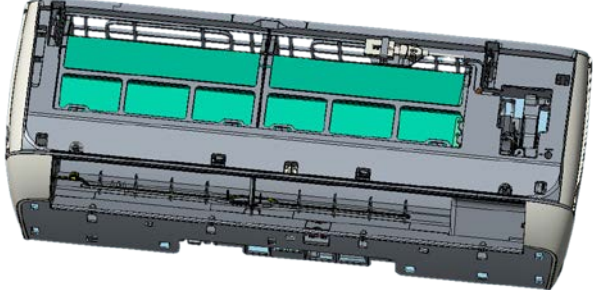

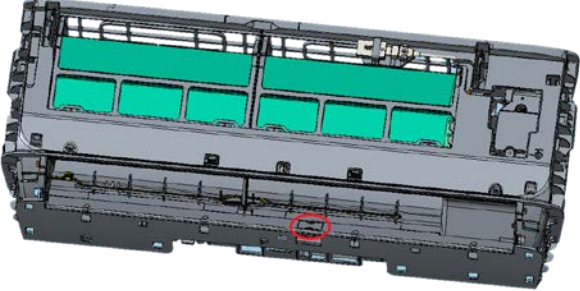
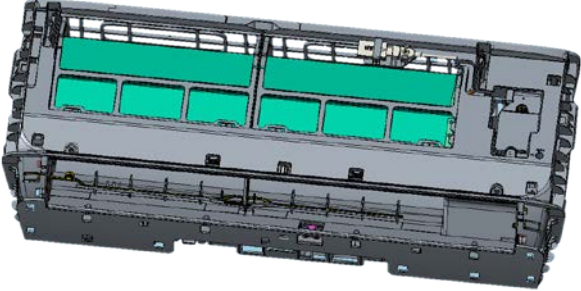
Parts	Procedure	Diagram
Front Panel	<ol style="list-style-type: none"> 1) Turn off the power, hold the middle panel with the middle finger 2) open the panel upwards, remove the panel fixing shaft, and remove the panel. 	
air louver	Remove axial sleeve of air louver, bend the louver outwards and then remove the louver.	
air filter	Loosen the clasp of filter, push the filter inward and then draw it upward to remove it.	

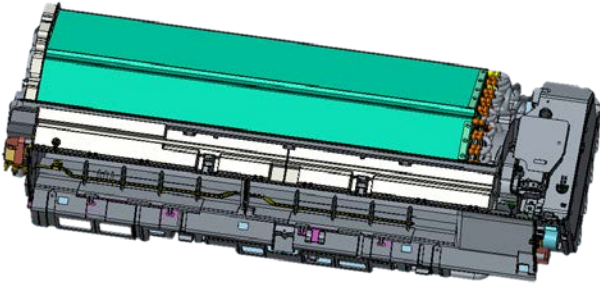
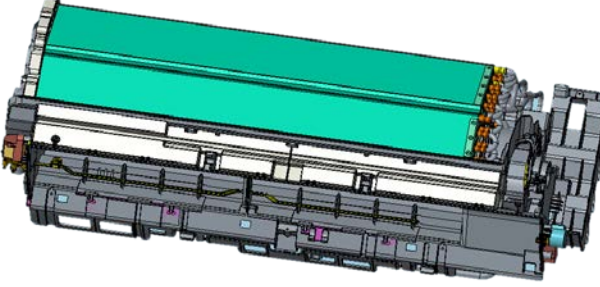
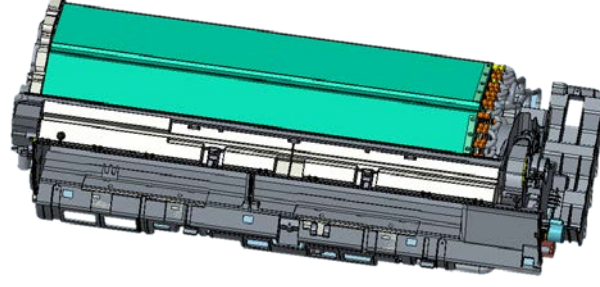
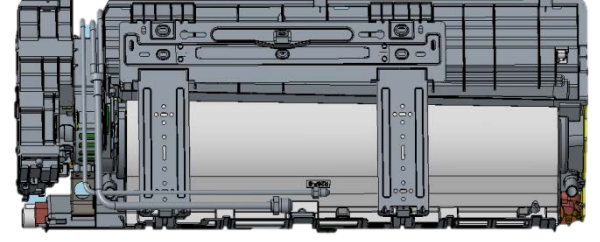
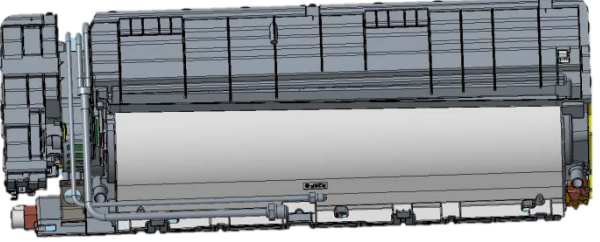

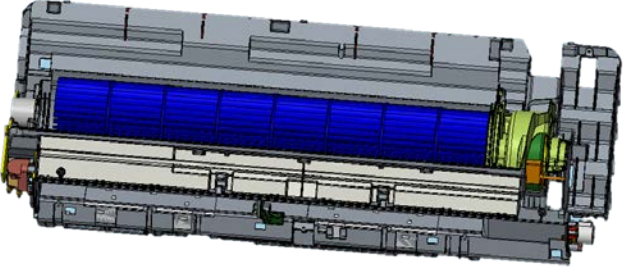
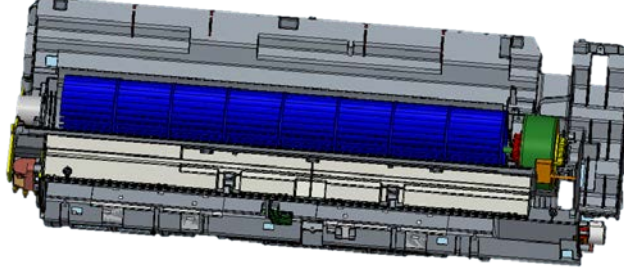
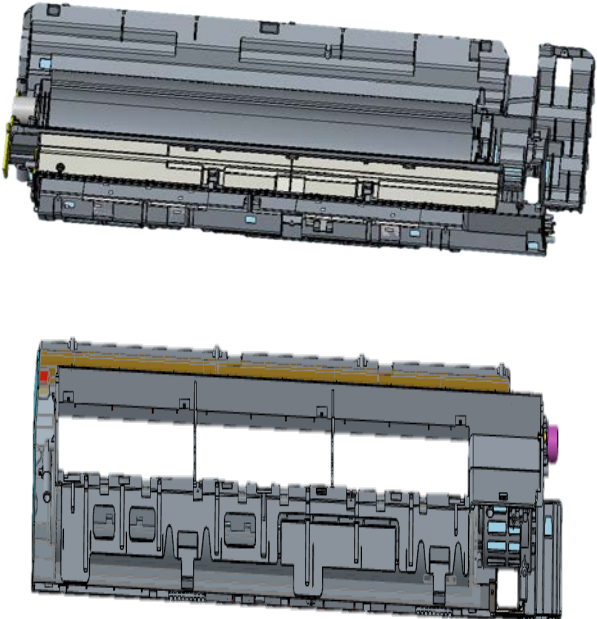
<p>Medium frame wiring cover</p>	<p>Loosen the screws of the medium frame wiring cover with screwdriver , remove the electric box cover.</p>	
<p>Decorative panel</p>	<p>Use thumb to open the middle frame and remove the decorative plate.</p>	
<p>Left and right terminal board</p>	<p>Remove left and right terminal board</p>	
<p>Screw cover</p>	<p>Press screw cover firmly on the middle frame , the  mark becomes unlocked, then remove the two screw caps .</p>	
<p>medium frame</p>	<p>Loosen the clasps of the medium frame, remove the medium frame.</p>	

<p>Electrical Parts (Main PCB)</p>	<ol style="list-style-type: none"> 1) Take all the connector of PCB upper side out.(Including Power cord) 2) Detach the outdoor unit connection wire from the terminal block. 3) If pulling the main PCB up, it will be taken out. 	
<p>air vent, louver link</p>	<p>Remove axial sleeve of louver link, bend the air vent outwards and then remove the air vent and louver link.</p>	
<p>Pipeline clamp</p>	<p>Remove the Pipeline clamp.</p>	
<p>Mounting plate</p>	<p>Remove the Mounting plate.</p>	
<p>Heat Exchanger</p>	<ol style="list-style-type: none"> 1) Loosen fixing earth screws of right side. 2) Detach the connection pipe. 3) Detach the holder pipe at the rear side. 4) Loosen fixing screws of right and left side. 5) Detach the heat exchanger from the indoor unit. 	

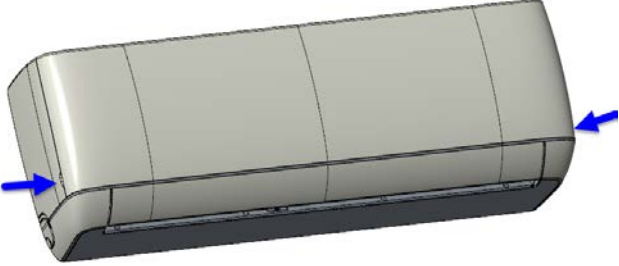
<p>Motor press plate</p>	<p>Remove the screw of the motor press plate and then remove the press plate.</p>	
<p>Fan Motor & Cross Fan</p>	<ol style="list-style-type: none"> 1) Loosen fixing screws and detach the motor holder. 2) Loosen fixing screw of fan motor. (with a M6 wrench) 3) Detach the fan motor from the fan. 4) Detach the fan from the left holder bearing. 	
<p>volute</p>	<p>Remove screws on volute and remove the volute.</p>	

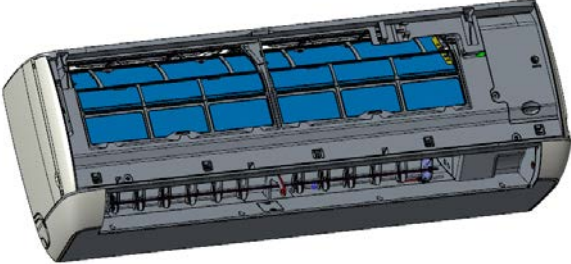
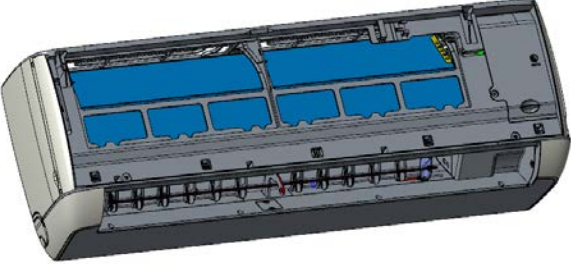
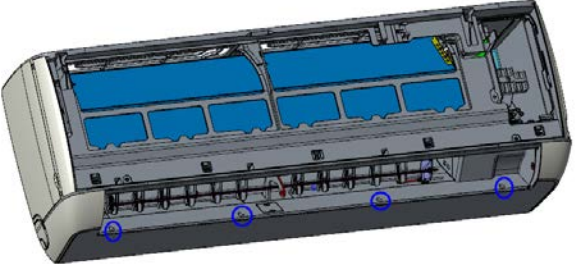
➤ 35J

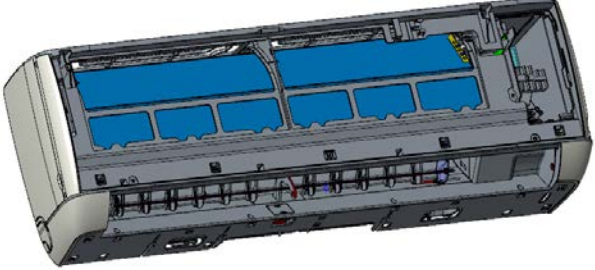
Parts	Procedure	Diagram
Front Panel	3) Turn off the power, hold the middle panel with the middle finger 4) open the panel upwards, remove the panel fixing shaft, and remove the panel.	
air louver	Remove axial sleeve of air louver, bend the louver outwards and then remove the louver.	
air filter	Loosen the clasp of filter, push the filter inward and then draw it upward to remove it.	
Medium frame wiring cover	Loosen the screws of the medium frame wiring cover with screwdriver, remove the electric box cover.	
Decorative panel	Use thumb to open the middle frame and remove the decorative plate.	

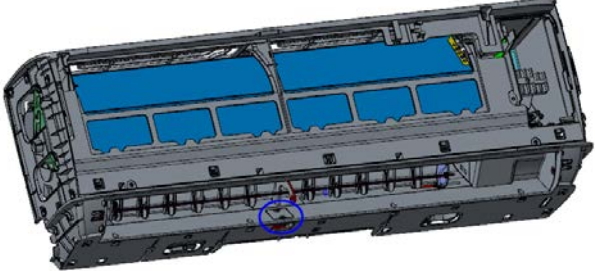
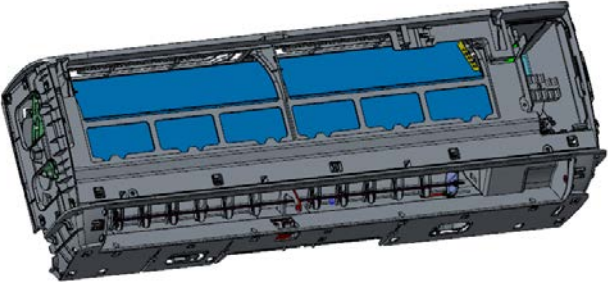
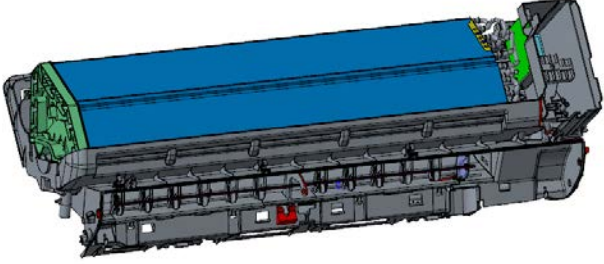
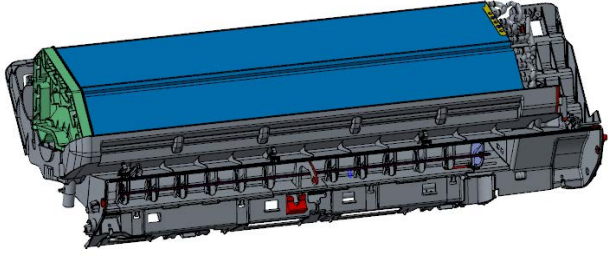
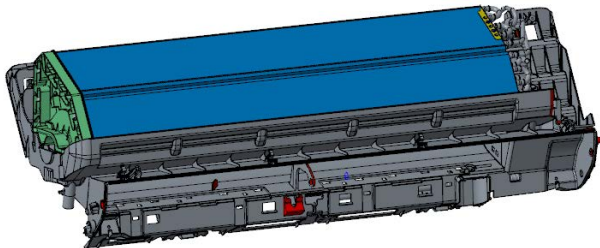

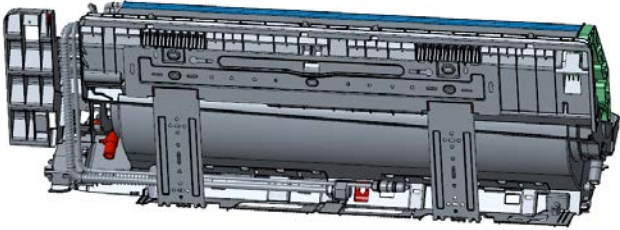
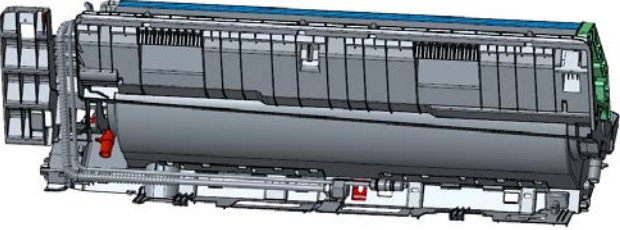
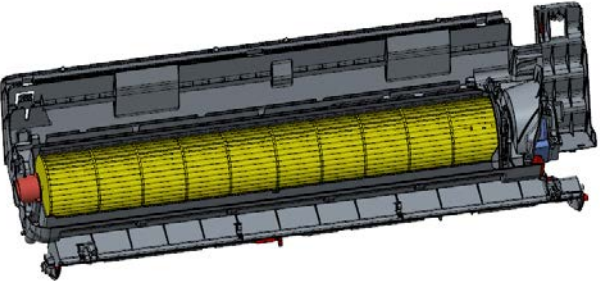
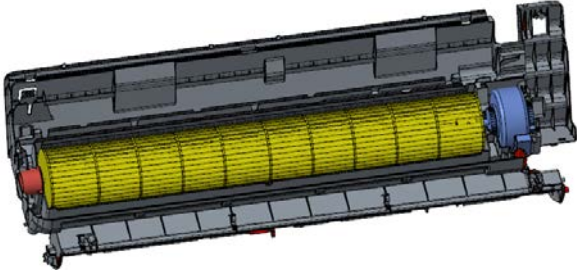
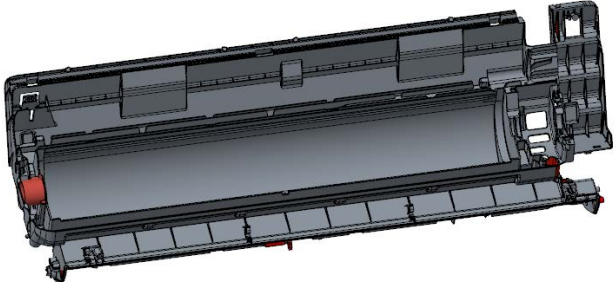
<p>Left and right terminal board</p>	<p>Remove left and right terminal board</p>	
<p>Screw cover</p>	<p>Press screw cover firmly on the middle frame , the  mark becomes unlocked, then remove the two screw caps .</p>	
<p>medium frame</p>	<p>Loosen the clasps of the medium frame, remove the medium frame.</p>	
<p>Electrical Parts (Main PCB)</p>	<p>1) Take all the connector of PCB upper side out.(Including Power cord) 2) Detach the outdoor unit connection wire from the terminal block. 3) If pulling the main PCB up, it will be taken out.</p>	
<p>air vent, louver link</p>	<p>Remove axial sleeve of louver link, bend the air vent outwards and then remove the air vent and louver link.</p>	
<p>Pipeline clamp</p>	<p>Remove the Pipeline clamp.</p>	

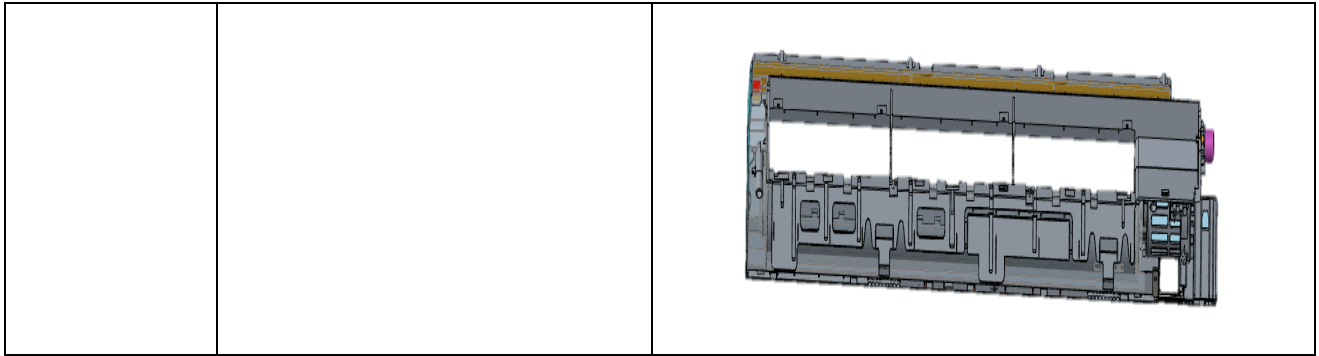
Mounting plate	Remove the Mounting plate.	
Heat Exchanger	<ol style="list-style-type: none"> 1) Loosen fixing earth screws of right side. 2) Detach the connection pipe. 3) Detach the holder pipe at the rear side. 4) Loosen fixing screws of right and left side. 5) Detach the heat exchanger from the indoor unit. 	
Motor press plate	Remove the screw of the motor press plate and then remove the press plate.	
Fan Motor & Cross Fan	<ol style="list-style-type: none"> 1) Loosen fixing screws and detach the motor holder. 2) Loosen fixing screw of fan motor. (with a M6 wrench) 3) Detach the fan motor from the fan. 4) Detach the fan from the left holder bearing. 	
volute	Remove screws on volute and remove the volute.	

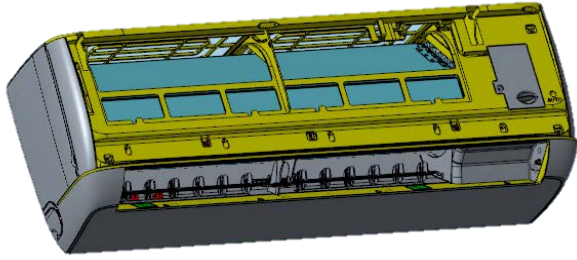
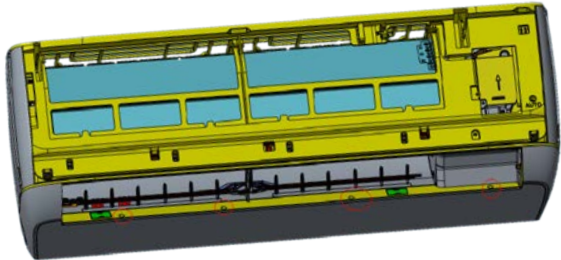
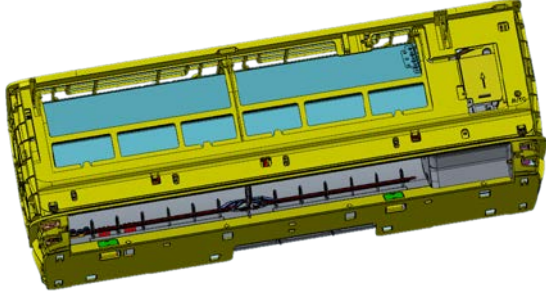

➤ 50J

Parts	Procedure	Diagram
Front Panel	5) Turn off the power, hold the middle panel with the middle finger 6) open the panel upwards, remove the panel fixing shaft, and remove the panel.	
air louver	Remove axial sleeve of air louver, bend the louver outwards and then remove the louver.	
air filter	Loosen the clasp of filter, push the filter inward and then draw it upward to remove it.	

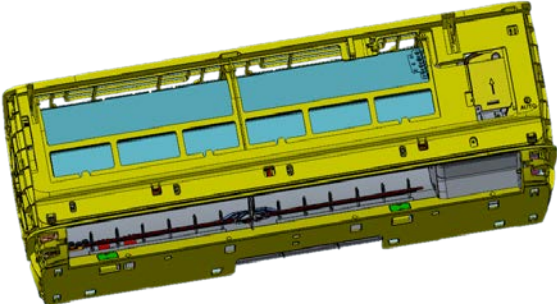
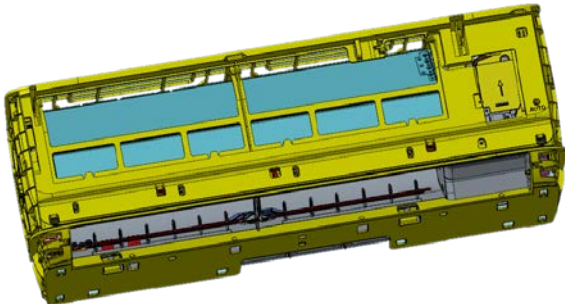
<p>Medium frame wiring cover</p>	<p>Loosen the screws of the medium frame wiring cover with screwdriver , remove the electric box cover.</p>	
<p>Decorative panel</p>	<p>Use thumb to open the middle frame and remove the decorative plate.</p>	
<p>Left and right terminal board</p>	<p>Remove left and right terminal board</p>	
<p>Screw cover</p>	<p>Press screw cover firmly on the middle frame , the  mark becomes unlocked, then remove the two screw caps .</p>	
<p>medium frame</p>	<p>Loosen the clasps of the medium frame, remove the medium frame.</p>	

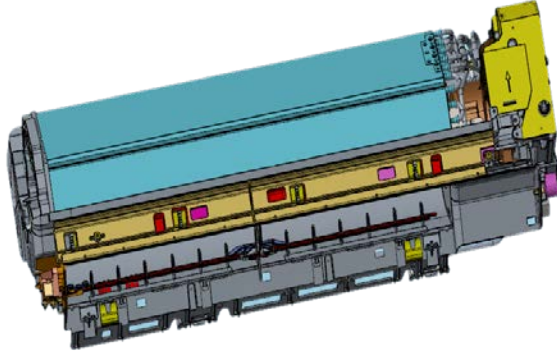
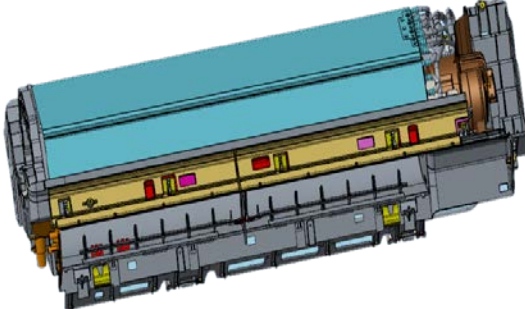
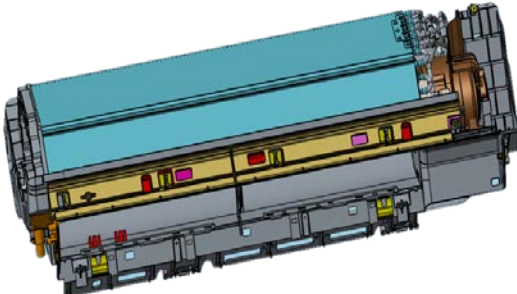
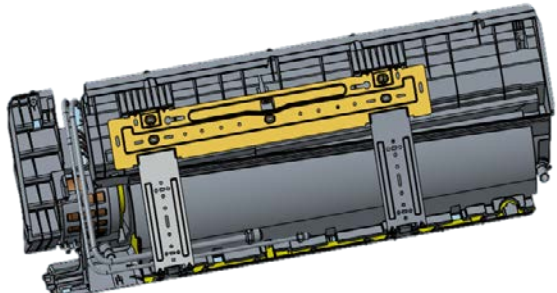
<p>Electrical Parts (Main PCB)</p>	<ol style="list-style-type: none"> 1) Take all the connector of PCB upper side out.(Including Power cord) 2) Detach the outdoor unit connection wire from the terminal block. 3) If pulling the main PCB up, it will be taken out. 	
<p>air vent, louver link</p>	<p>Remove axial sleeve of louver link, bend the air vent outwards and then remove the air vent and louver link.</p>	
<p>Pipeline clamp</p>	<p>Remove the Pipeline clamp.</p>	
<p>Mounting plate</p>	<p>Remove the Mounting plate.</p>	

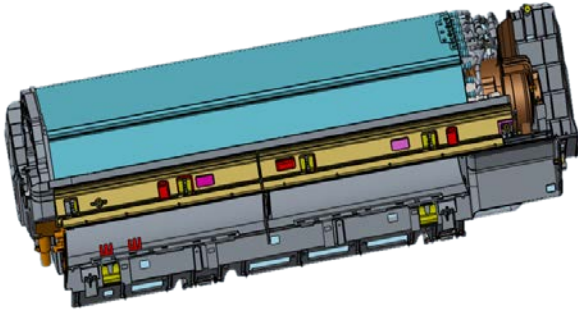
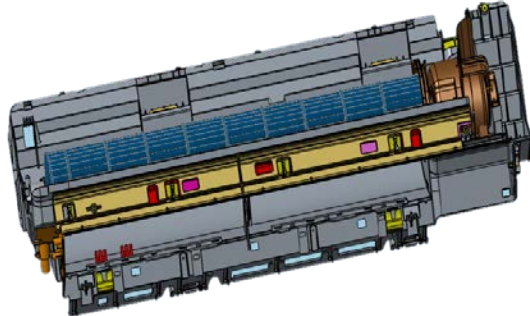
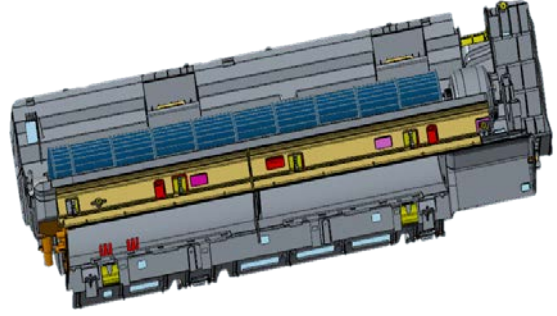
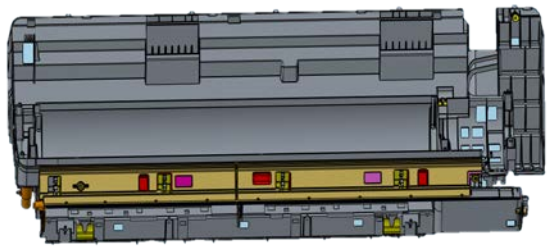
Heat Exchanger	<ol style="list-style-type: none"> 1) Loosen fixing earth screws of right side. 2) Detach the connection pipe. 3) Detach the holder pipe at the rear side. 4) Loosen fixing screws of right and left side. 5) Detach the heat exchanger from the indoor unit. 	
Motor press plate	Remove the screw of the motor press plate and then remove the press plate.	
Fan Motor & Cross Fan	<ol style="list-style-type: none"> 1) Loosen fixing screws and detach the motor holder. 2) Loosen fixing screw of fan motor. (with a M6 wrench) 3) Detach the fan motor from the fan. 4) Detach the fan from the left holder bearing. 	
volute	Remove screws on volute and remove the volute.	

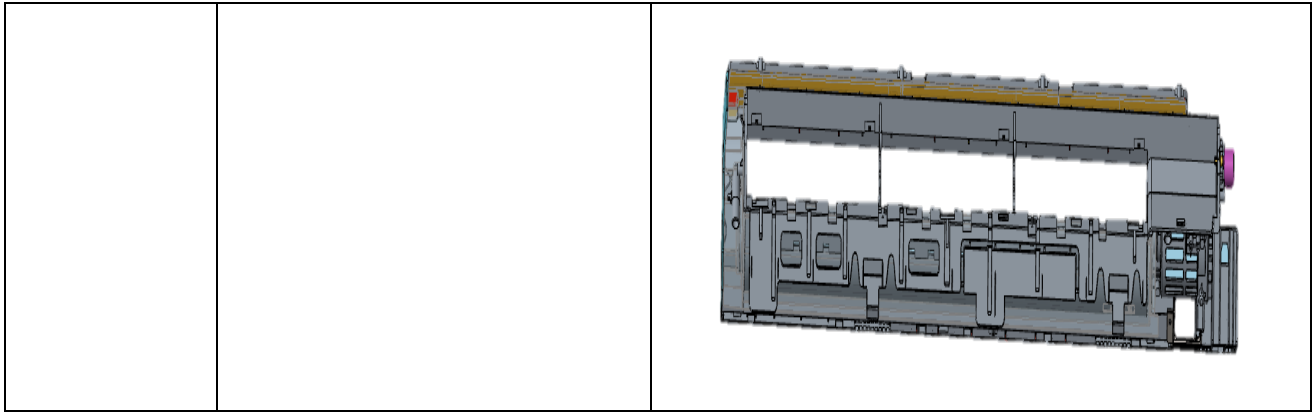

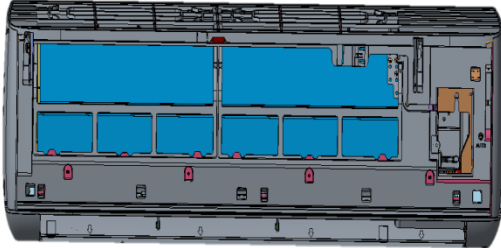
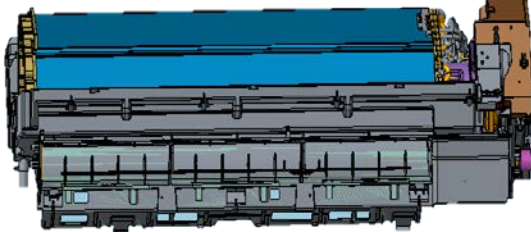
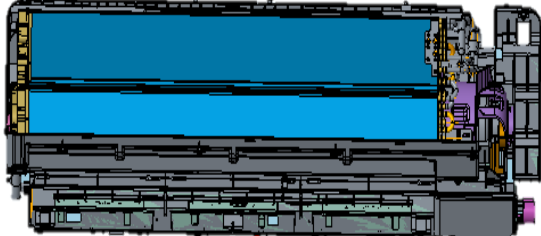
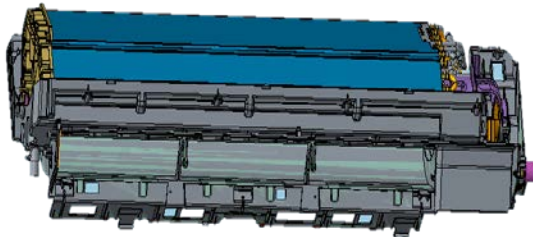
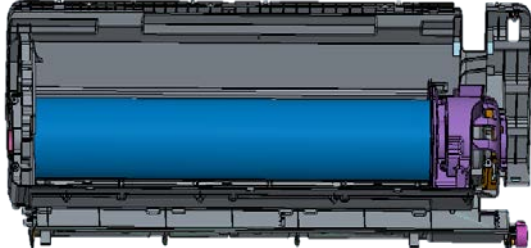

➤ **53J**

Parts	Procedure	Diagram
Front Panel	7) Turn off the power, hold the middle panel with the middle finger, 8) open the panel upwards, remove the panel fixing shaft, and remove the panel.	
air louver	Remove axial sleeve of air louver, bend the louver outwards and then remove the louver.	
air filter	Loosen the clasp of filter, push the filter inward and then draw it upward to remove it.	
Medium frame wiring cover	Loosen the screws of the medium frame wiring cover with screwdriver , remove the electric box cover.	

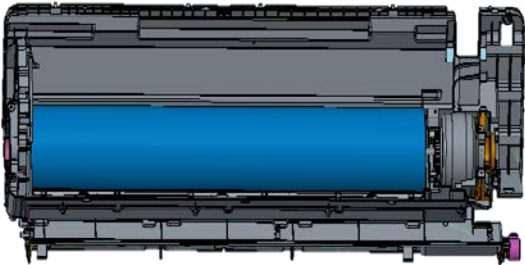
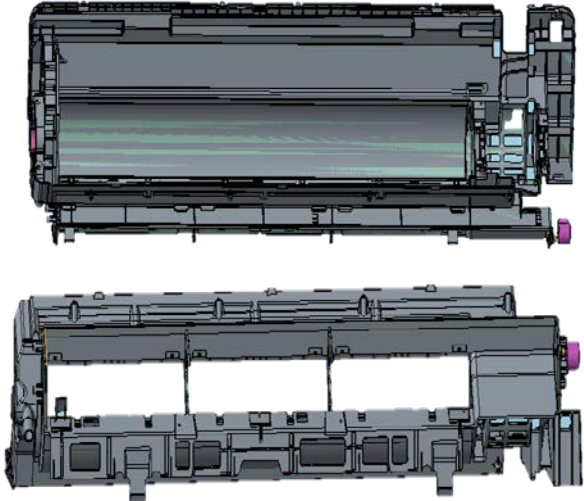
<p>medium frame</p>	<p>Loosen the clasps of the medium frame , remove the medium frame.</p>	
<p>Electrical Parts (Main PCB)</p>	<ol style="list-style-type: none"> 1) Take all the connector of PCB upper side out.(Including Power cord) 2) Detach the outdoor unit connection wire from the terminal block. 3) If pulling the main PCB up, it will be taken out. 	
<p>air vent, louver link</p>	<p>Remove axial sleeve of louver link, bend the air vent outwards and then remove the air vent and louver link.</p>	
<p>Heat Exchanger</p>	<ol style="list-style-type: none"> 1) Loosen fixing earth screws of right side. 2) Detach the connection pipe. 3) Detach the holder pipe at the rear side. 4) Loosen fixing screws of right and left side. 5) Detach the heat exchanger from the indoor unit. 	
<p>Motor press plate</p>	<p>Remove the screw of the motor press plate and then remove the press plate.</p>	

<p>Fan Motor & Cross Fan</p>	<p>1) Loosen fixing screws and detach the motor holder. 2) Loosen fixing screw of fan motor. (with a M6 wrench) 3) Detach the fan motor from the fan. 4) Detach the fan from the left holder bearing.</p>	
<p>volute</p>	<p>Remove screws on volute and remove the volute.</p>	

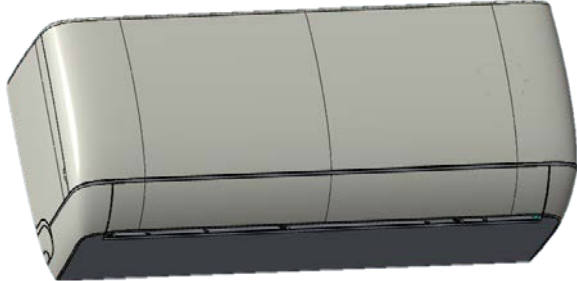

➤ **70J**

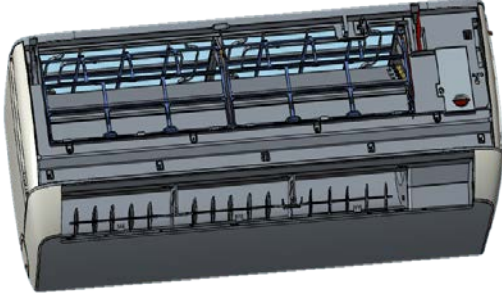
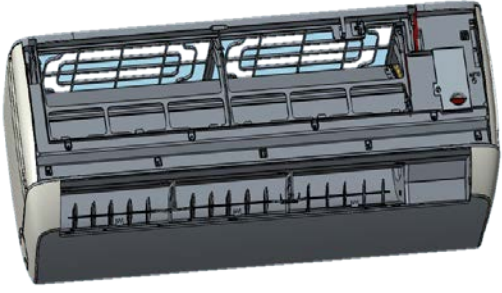
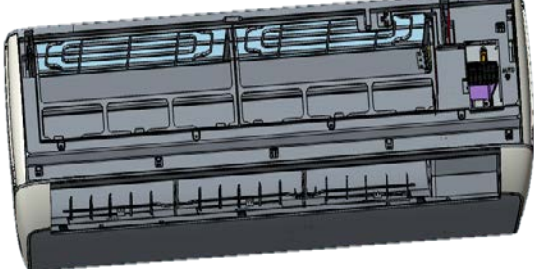
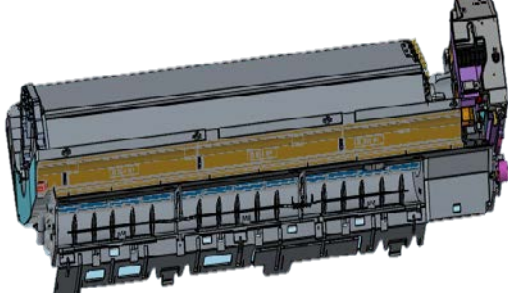
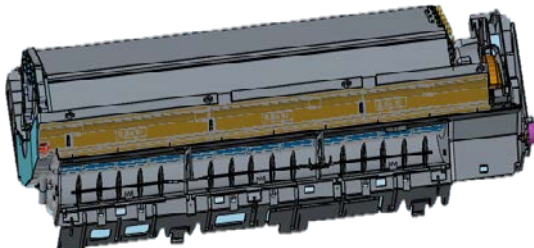
Parts	Procedure	Diagram
<p>Front Panel</p>	<p>9) Turn off the power, hold the middle panel with the middle finger, 10) open the panel upwards, remove the panel fixing shaft, and remove the panel.</p>	
<p>air louver</p>	<p>Remove axial sleeve of air louver, bend the louver outwards and then remove the louver.</p>	

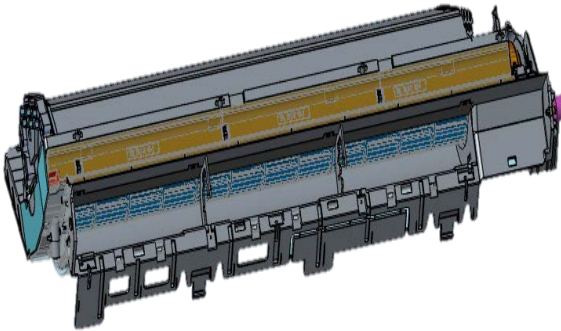
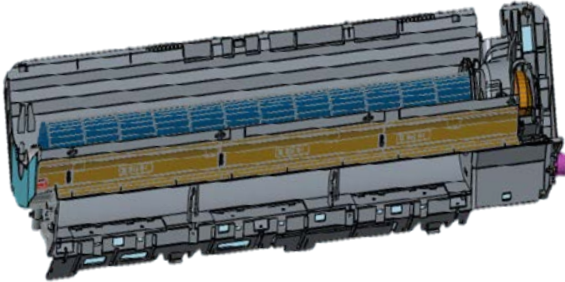
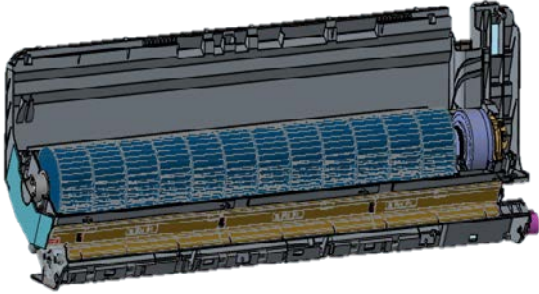
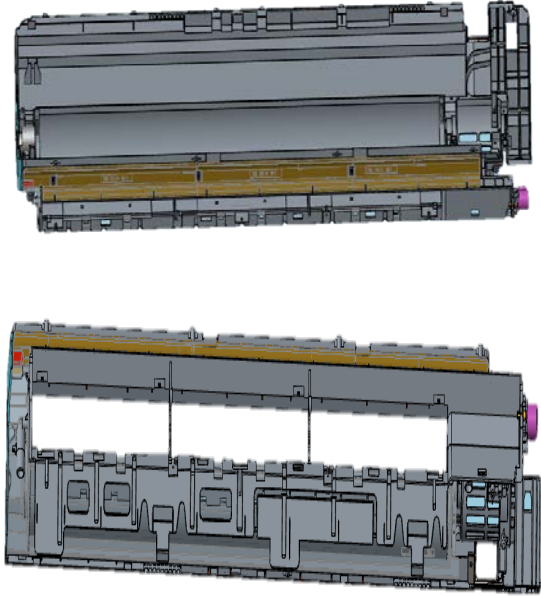
air filter	Loosen the clasp of filter, push the filter inward and then draw it upward to remove it.	
Medium frame wiring cover	Loosen the screws of the medium frame wiring cover with screwdriver , remove the electric box cover.	
medium frame	Loosen the clasps of the medium frame , remove the medium frame.	
Electrical Parts (Main PCB)	<ol style="list-style-type: none"> 1) Take all the connector of PCB upper side out.(Including Power cord) 2) Detach the outdoor unit connection wire from the terminal block. 3) If pulling the main PCB up, it will be taken out. 	
air vent, louver link	Remove axial sleeve of louver link, bend the air vent outwards and then remove the air vent and louver link.	

Heat Exchanger	<ol style="list-style-type: none"> 1) Loosen fixing earth screws of right side. 2) Detach the connection pipe. 3) Detach the holder pipe at the rear side. 4) Loosen fixing screws of right and left side. 5) Detach the heat exchanger from the indoor unit. 	
Motor press plate	Remove the screw of the motor press plate and then remove the press plate.	
Fan Motor & Cross Fan	<ol style="list-style-type: none"> 1) Loosen fixing screws and detach the motor holder. 2) Loosen fixing screw of fan motor. (with a M6 wrench) 3) Detach the fan motor from the fan. 4) Detach the fan from the left holder bearing. 	
volute	Remove screws on volute and remove the volute.	

4-2 Outdoor Unit

Part	Procedure	Diagram
top cover	Turn off the power , remove connection screws among top cover plate, front panel and right side panel, then remove the top cover.	
电控盒盖板		
panel grille	Remove connection screws between the front grille and the front panel .Then remove the front grille.	

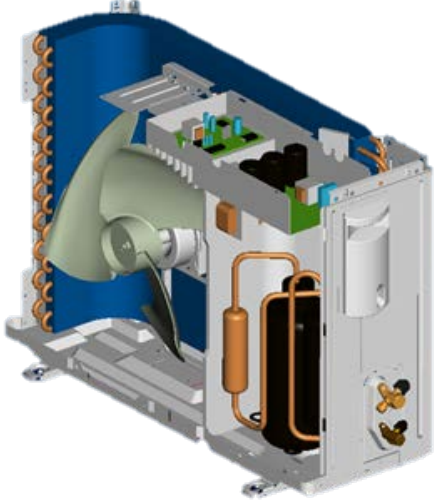
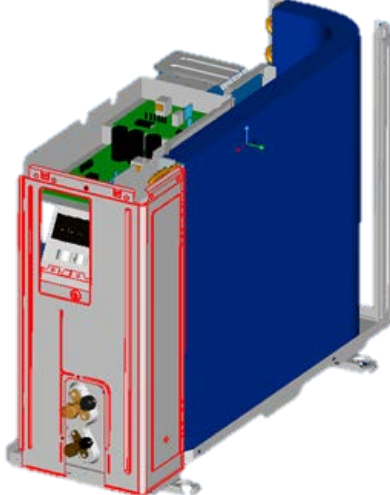
<p>Front panel</p>	<p>Remove connection screws connecting the front panel with the chassis and the motor support , and remove the front pannel.</p>	
<p>E-part cover</p>	<p>Remove connection screws Connecting the right side panel, then remove the E-part cover.</p>	
<p>Right side panel</p>	<p>Remove connection screws connecting the right side panel with the valve support and electric box, then remove the right side panel.</p>	

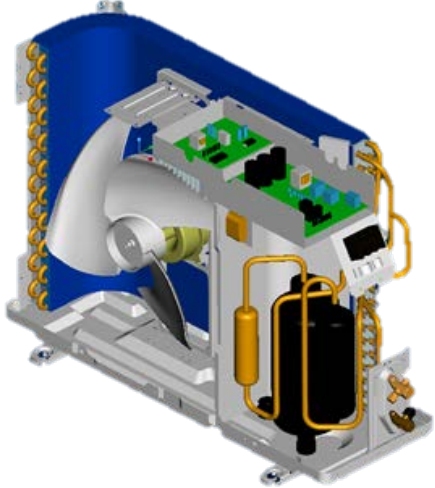
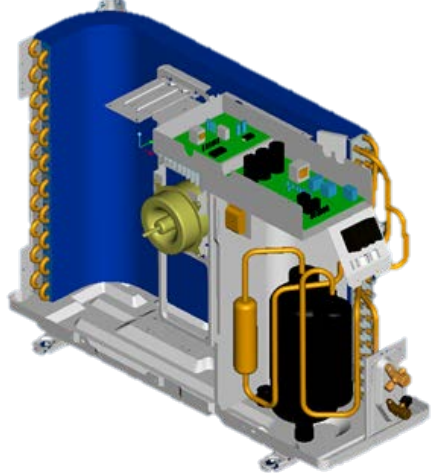
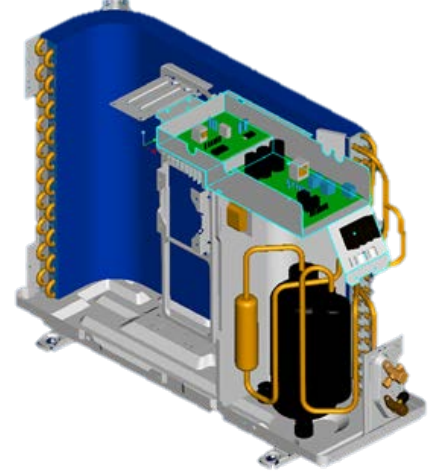
<p>Axial flow blade</p>	<p>Remove the nut fixing the blade and then remove the axial flow blade.</p>	
<p>Outer motor</p>	<p>Remove the tapping screws fixing the motor, pull out the lead-out wire and remove the motor.</p>	
<p>Electric box assy</p>	<p>Loosen the wire and disconnect the terminal. Lift to remove the electric box assy.</p>	

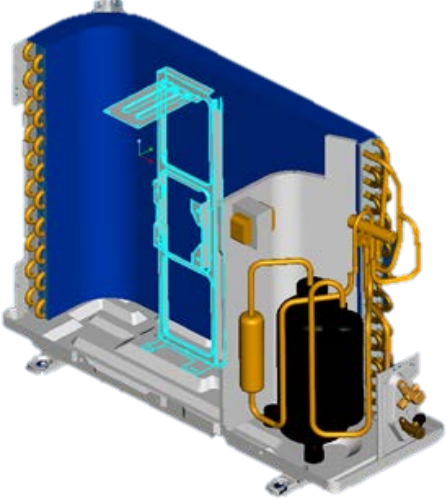
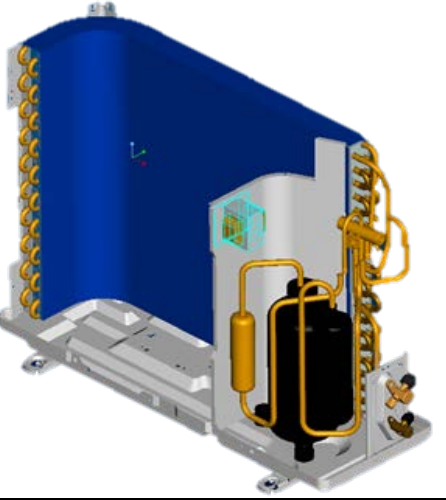
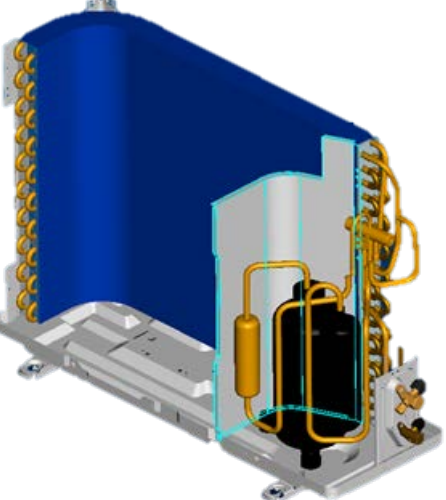
<p>Motor support</p>	<p>Remove the tapping screws fixing the motor support . Lift motor support to remove it.</p>	
<p>reactor</p>	<p>Remove 2 connection screws Connecting the partition board, remove the reactor.</p>	
<p>Partition board</p>	<p>Loosen the screws of the partition board , then lift and pull the partition board to remove .</p>	

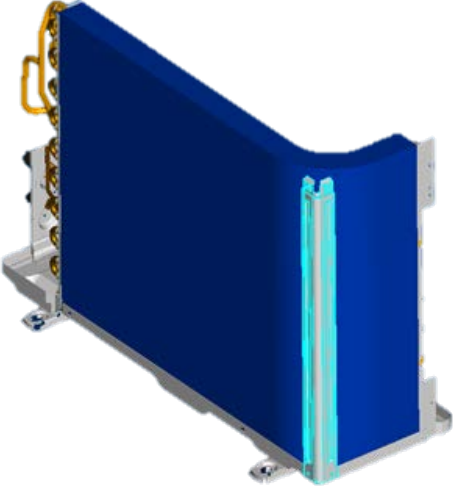
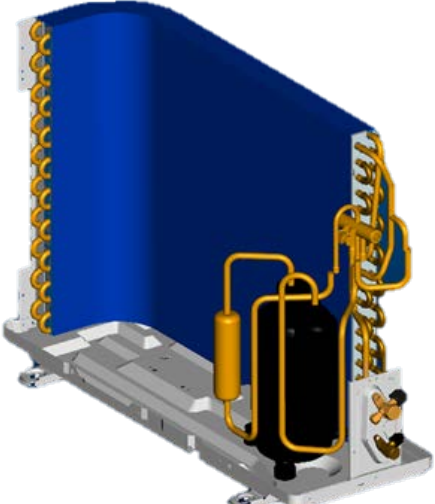
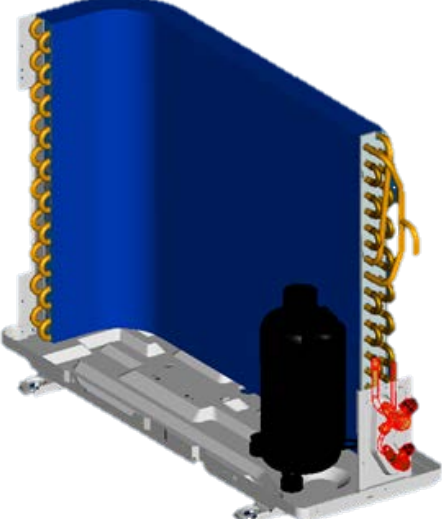
<p>left side support plate</p>	<p>Remove connection screws connecting the left side support plate with the valve support, then remove the left side support plate.</p>	
<p>Pipeline assembly</p>	<p>After the unit is discharged, Unscrew the fastening nut of the 4-way Valve Assy coil and remove the pipeline assembly.</p>	
<p>Stop valve assembly</p>	<ol style="list-style-type: none"> 1) Remove the screws fixing the gas 2) valve. Unsolder the welding spot connecting gas valve and air return pipe and remove the gas valve. 3) Remove the screws fixing liquid valve. Unsolder the welding spot connecting liquid valve and remove the liquid valve. 	

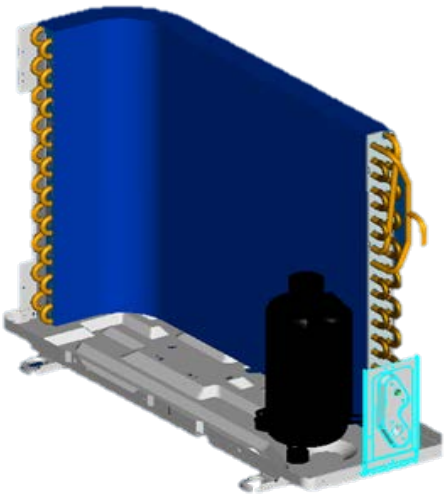
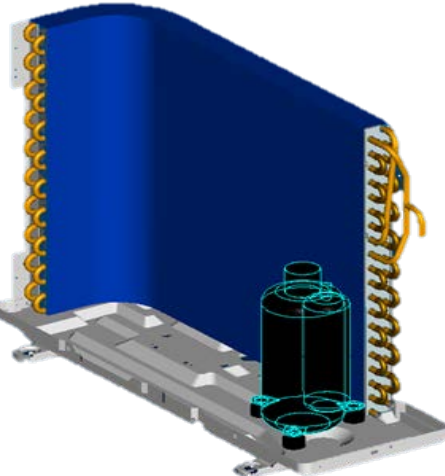
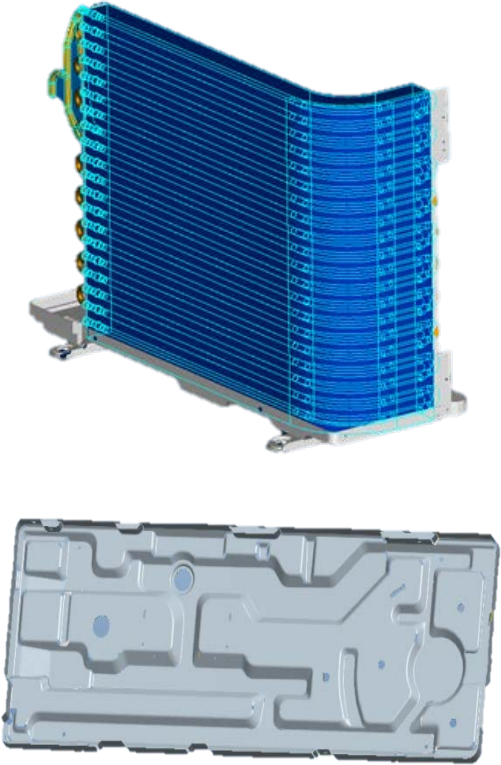
<p>Valve plate</p>	<p>Loosen 1 footing screws of valve plate, remove the valve plate.</p>	
<p>Compressor</p>	<p>Loosen 3 footing screws of compressor, Remove and remove the compressor.</p>	
<p>condenser</p>	<p>Loosen 2 fixing screws Connecting chassis, and remove the condenser. Last remaining chassis.</p>	

Appendix

Common Sensor R-T Analysis Table

Temperature sensor R-T analysis table (15K)									
Sensor standard resistance : 15K Ω \pm 3% B:B(25/50)=3950K \pm 2%Reference temperature : 25 (°C)									
MCU_A/D exchange \pm 3LSB (at10bit)									
Series (sampling) resistor : 10 (K Ω) \pm 1% (except disk sensor)									
Single chip (A/D reference voltage) supply voltage : 5V									
Temp (°C)	Resistance (K Ω)			MCU Input voltage (V)			A/D Exchange value		
	MIN	TYP	MAX	MIN	TYP	MAX	MIN	TYP	MAX
-25.0	183.4	199.1	216.0	0.219	0.239	0.261	42	49	56
-24.0	172.8	187.4	203.0	0.233	0.253	0.276	45	52	60
-23.0	162.9	176.5	190.9	0.247	0.268	0.292	47	55	63
-22.0	153.7	166.2	179.6	0.261	0.284	0.308	50	58	66
-21.0	145.0	156.7	169.1	0.277	0.300	0.326	54	61	70
-20.0	136.9	147.7	159.2	0.293	0.317	0.344	57	65	73
-19.0	129.2	139.3	150.0	0.310	0.335	0.363	60	69	77
-18.0	122.1	131.4	141.4	0.327	0.354	0.382	64	72	81
-17.0	115.4	124.1	133.3	0.346	0.373	0.402	68	76	85
-16.0	109.1	117.2	125.7	0.365	0.393	0.424	72	81	90
-15.0	103.1	110.7	118.6	0.385	0.414	0.446	76	85	94
-14.0	97.59	104.6	112.0	0.406	0.436	0.469	80	89	99
-13.0	92.37	98.88	105.8	0.428	0.459	0.493	85	94	104
-12.0	87.45	93.52	99.92	0.451	0.483	0.518	89	99	109
-11.0	82.83	88.48	94.43	0.474	0.508	0.543	94	104	114
-10.0	78.48	83.74	89.27	0.499	0.533	0.570	99	109	120
-9.0	74.39	79.29	84.43	0.525	0.560	0.598	104	115	125
-8.0	70.54	75.10	79.88	0.551	0.588	0.626	110	120	131
-7.0	66.90	71.15	75.61	0.579	0.616	0.656	116	126	137
-6.0	63.48	67.44	71.59	0.607	0.646	0.686	121	132	144
-5.0	60.25	63.95	67.80	0.637	0.676	0.718	127	138	150
-4.0	57.21	60.65	64.24	0.668	0.708	0.750	134	145	157
-3.0	54.34	57.55	60.89	0.699	0.740	0.784	140	152	163
-2.0	51.63	54.62	57.73	0.732	0.774	0.818	147	158	171
-1.0	49.07	51.86	54.76	0.766	0.808	0.853	154	166	178
0.0	46.65	49.25	51.95	0.800	0.844	0.890	161	173	185
1.0	44.37	46.79	49.31	0.836	0.880	0.927	168	180	193
2.0	42.21	44.47	46.81	0.873	0.918	0.965	176	188	201
3.0	40.17	42.28	44.46	0.911	0.956	1.005	183	196	209
4.0	38.24	40.20	42.24	0.949	0.996	1.045	191	204	217
5.0	36.41	38.25	40.14	0.989	1.036	1.086	200	212	225
6.0	34.68	36.39	38.16	1.030	1.078	1.128	208	221	234
7.0	33.05	34.64	36.29	1.072	1.120	1.170	216	229	243

8.0	31.50	32.99	34.52	1.114	1.163	1.214	225	238	252
9.0	30.03	31.42	32.84	1.158	1.207	1.258	234	247	261
10.0	28.64	29.94	31.26	1.203	1.252	1.304	243	256	270
11.0	27.32	28.53	29.77	1.248	1.298	1.350	253	266	279
12.0	26.07	27.20	28.35	1.294	1.344	1.396	262	275	289
13.0	24.89	25.94	27.01	1.341	1.391	1.443	272	285	299
14.0	23.76	24.74	25.74	1.389	1.439	1.491	281	295	308
15.0	22.69	23.61	24.54	1.437	1.488	1.540	291	305	318
16.0	21.68	22.53	23.40	1.486	1.537	1.589	301	315	328
17.0	20.72	21.51	22.32	1.536	1.587	1.639	312	325	339
18.0	19.80	20.55	21.30	1.587	1.637	1.689	322	335	349
19.0	18.94	19.63	20.33	1.637	1.687	1.739	332	346	359
20.0	18.11	18.75	19.40	1.689	1.739	1.790	343	356	370
21.0	17.33	17.93	18.53	1.741	1.790	1.841	354	367	380
22.0	16.58	17.14	17.70	1.793	1.842	1.893	364	377	391
23.0	15.87	16.39	16.91	1.846	1.895	1.945	375	388	401
24.0	15.19	15.68	16.16	1.899	1.947	1.997	386	399	412
25.0	14.55	15.00	15.45	1.953	2.000	2.049	397	410	423
26.0	13.91	14.36	14.80	2.004	2.053	2.103	407	420	434
27.0	13.31	13.74	14.18	2.056	2.106	2.157	418	431	445
28.0	12.73	13.16	13.59	2.107	2.159	2.212	429	442	456
29.0	12.18	12.60	13.03	2.159	2.212	2.267	439	453	467
30.0	11.66	12.08	12.49	2.211	2.264	2.321	450	464	478
31.0	11.17	11.57	11.98	2.262	2.318	2.374	460	475	489
32.0	10.69	11.09	11.49	2.314	2.371	2.429	471	486	500
33.0	10.24	10.63	11.03	2.365	2.424	2.483	481	496	511
34.0	9.816	10.20	10.59	2.416	2.475	2.536	492	507	522
35.0	9.408	9.782	10.16	2.468	2.528	2.589	502	518	533
36.0	9.019	9.385	9.758	2.518	2.579	2.641	513	528	544
37.0	8.648	9.007	9.372	2.568	2.631	2.694	523	539	555
38.0	8.294	8.645	9.003	2.619	2.682	2.745	533	549	565
39.0	7.957	8.300	8.651	2.668	2.732	2.797	543	560	576
40.0	7.635	7.971	8.315	2.718	2.782	2.847	554	570	586
41.0	7.328	7.657	7.993	2.766	2.832	2.898	564	580	596
42.0	7.034	7.356	7.686	2.815	2.881	2.947	573	590	607
43.0	6.755	7.069	7.391	2.863	2.929	2.996	583	600	617
44.0	6.487	6.795	7.110	2.910	2.977	3.045	593	610	627
45.0	6.232	6.532	6.841	2.957	3.024	3.092	603	619	636
46.0	5.988	6.282	6.584	3.003	3.071	3.139	612	629	646
47.0	5.755	6.042	6.337	3.049	3.117	3.185	621	638	655
48.0	5.532	5.812	6.101	3.094	3.162	3.231	631	648	665
49.0	5.319	5.593	5.875	3.138	3.207	3.275	640	657	674
50.0	5.115	5.382	5.659	3.181	3.251	3.319	649	666	683
51.0	4.919	5.180	5.450	3.225	3.294	3.362	657	675	692
52.0	4.732	4.987	5.251	3.267	3.336	3.405	666	683	700

53.0	4.553	4.802	5.060	3.309	3.378	3.446	675	692	709
54.0	4.382	4.625	4.877	3.350	3.419	3.487	683	700	717
55.0	4.219	4.457	4.703	3.390	3.459	3.527	691	708	725
56.0	4.061	4.293	4.534	3.429	3.498	3.566	699	716	733
57.0	3.911	4.137	4.373	3.468	3.537	3.604	707	724	741
58.0	3.767	3.988	4.218	3.506	3.574	3.642	715	732	749
59.0	3.630	3.845	4.070	3.543	3.611	3.678	723	740	756
60.0	3.498	3.708	3.927	3.580	3.648	3.714	730	747	764
61.0	3.371	3.577	3.791	3.616	3.683	3.749	737	754	771
62.0	3.250	3.450	3.660	3.650	3.717	3.783	745	761	778
63.0	3.134	3.329	3.534	3.685	3.751	3.816	752	768	785
64.0	3.022	3.213	3.413	3.718	3.784	3.848	758	775	791
65.0	2.915	3.102	3.297	3.751	3.816	3.880	765	782	798
66.0	2.813	2.995	3.185	3.783	3.848	3.911	772	788	804
67.0	2.714	2.892	3.078	3.814	3.878	3.941	778	794	810
68.0	2.620	2.793	2.975	3.845	3.908	3.970	784	800	816
69.0	2.529	2.698	2.876	3.874	3.938	3.999	790	806	822
70.0	2.442	2.607	2.781	3.903	3.966	4.026	796	812	828
71.0	2.358	2.519	2.689	3.932	3.994	4.054	802	818	833
72.0	2.278	2.435	2.601	3.960	4.021	4.080	808	823	839
73.0	2.200	2.354	2.516	3.987	4.047	4.106	813	829	844
74.0	2.126	2.276	2.435	4.013	4.073	4.131	819	834	849
75.0	2.055	2.201	2.356	4.039	4.098	4.155	824	839	854
76.0	1.986	2.129	2.280	4.064	4.122	4.178	829	844	859
77.0	1.920	2.060	2.208	4.088	4.146	4.201	834	849	863
78.0	1.857	1.993	2.138	4.112	4.169	4.223	839	854	868
79.0	1.796	1.929	2.070	4.135	4.191	4.245	844	858	872
80.0	1.737	1.867	2.005	4.158	4.213	4.266	849	863	877
81.0	1.681	1.808	1.942	4.180	4.234	4.287	853	867	881
82.0	1.626	1.750	1.882	4.201	4.255	4.307	857	871	885
83.0	1.574	1.695	1.824	4.222	4.275	4.326	862	876	889
84.0	1.524	1.642	1.767	4.243	4.295	4.344	866	880	893
85.0	1.475	1.590	1.713	4.262	4.314	4.363	870	884	897
86.0	1.428	1.541	1.661	4.282	4.332	4.381	874	887	900
87.0	1.383	1.493	1.611	4.300	4.350	4.398	878	891	904
88.0	1.340	1.447	1.562	4.319	4.368	4.414	881	895	907
89.0	1.298	1.403	1.515	4.336	4.385	4.431	885	898	910
90.0	1.258	1.360	1.470	4.354	4.401	4.446	889	901	914
91.0	1.219	1.319	1.426	4.370	4.417	4.462	892	905	917
92.0	1.181	1.279	1.384	4.387	4.433	4.477	895	908	920
93.0	1.145	1.241	1.343	4.403	4.448	4.491	899	911	923
94.0	1.110	1.204	1.304	4.418	4.463	4.505	902	914	926
95.0	1.077	1.168	1.266	4.433	4.477	4.518	905	917	928
96.0	1.044	1.134	1.229	4.448	4.491	4.532	908	920	931
97.0	1.013	1.100	1.194	4.462	4.505	4.544	911	923	934

98.0	0.9826	1.068	1.160	4.476	4.518	4.557	914	925	936
99.0	0.9535	1.037	1.127	4.489	4.530	4.569	916	928	939
100.0	0.9252	1.007	1.095	4.502	4.543	4.580	919	930	941
101.0	0.8981	0.9778	1.064	4.515	4.555	4.592	922	933	943
102.0	0.8717	0.9497	1.034	4.527	4.566	4.603	924	935	946
103.0	0.8463	0.9225	1.005	4.539	4.578	4.613	927	938	948
104.0	0.8218	0.8963	0.9767	4.551	4.589	4.624	929	940	950
105.0	0.7981	0.8710	0.9497	4.562	4.599	4.634	931	942	952

Temperature sensor R-T analysis table (20K)

Sensor standard resistance : 20K Ω \pm 3% B:B(25/50)=3950K \pm 2% reference temperature : 25 ($^{\circ}$ C)

MCU_A/D exchange \pm 3LSB (at10bit)

Series (sampling) resistor : 10 (K Ω) \pm 1%

Single chip (A/D reference voltage) supply voltage : 5V

Temp ($^{\circ}$ C)	Resistance (K Ω)			MCU Input voltage (V)			A/D Exchange value		
	MIN	TYP	MAX	MIN	TYP	MAX	MIN	TYP	MAX
-30	318.3	347.0	377.6	0.128	0.140	0.154	23	29	34
-29	299.6	326.2	354.6	0.136	0.149	0.163	25	30	36
-28	282.2	306.9	333.4	0.144	0.158	0.173	27	32	38
-27	265.9	289.0	313.5	0.153	0.167	0.183	28	34	40
-26	250.8	272.2	295.1	0.162	0.177	0.194	30	36	43
-25	236.6	256.5	277.9	0.172	0.188	0.205	32	38	45
-24	223.3	241.9	261.8	0.182	0.198	0.216	34	41	47
-23	210.9	228.2	246.7	0.193	0.210	0.229	37	43	50
-22	199.2	215.3	232.6	0.204	0.222	0.241	39	45	52
-21	188.3	203.3	219.4	0.216	0.234	0.255	41	48	55
-20	178.0	192.0	207.0	0.228	0.248	0.268	44	51	58
-19	168.3	181.4	195.4	0.241	0.261	0.283	46	54	61
-18	159.2	171.4	184.4	0.255	0.276	0.298	49	56	64
-17	150.7	162.0	174.2	0.269	0.291	0.314	52	60	67
-16	142.6	153.2	164.6	0.284	0.306	0.331	55	63	71
-15	135.0	144.9	155.5	0.299	0.323	0.348	58	66	74
-14	127.9	137.1	147.0	0.315	0.340	0.366	62	70	78
-13	121.2	129.8	138.9	0.333	0.358	0.385	65	73	82
-12	114.9	122.9	131.4	0.350	0.376	0.404	69	77	86
-11	108.9	116.4	124.3	0.369	0.396	0.424	73	81	90
-10	103.3	110.3	117.7	0.388	0.416	0.445	76	85	94
-9	98.00	104.5	111.4	0.408	0.437	0.467	81	89	99
-8	93.01	99.10	105.6	0.429	0.458	0.490	85	94	103
-7	88.29	93.98	100.0	0.450	0.481	0.513	89	98	108
-6	83.84	89.15	94.78	0.473	0.504	0.538	94	103	113
-5	79.63	84.60	89.85	0.496	0.529	0.563	99	108	118
-4	75.67	80.30	85.12	0.521	0.554	0.589	104	113	124
-3	71.91	76.24	80.75	0.546	0.580	0.616	109	119	129
-2	68.37	72.41	76.62	0.572	0.607	0.644	114	124	135
-1	65.02	68.79	72.72	0.599	0.635	0.672	120	130	141
0	61.85	65.37	69.04	0.627	0.663	0.702	125	136	147
1	58.85	62.14	65.56	0.656	0.693	0.732	131	142	153
2	56.01	59.08	62.28	0.686	0.724	0.764	137	148	159
3	53.33	56.20	59.18	0.717	0.755	0.796	144	155	166
4	50.79	53.46	56.25	0.748	0.788	0.829	150	161	173
5	48.38	50.88	53.43	0.782	0.821	0.864	157	168	180
6	46.10	48.43	50.81	0.815	0.856	0.899	164	175	187
7	43.94	46.12	48.34	0.850	0.891	0.934	171	182	194
8	41.90	43.92	45.99	0.886	0.927	0.971	178	190	202
9	39.95	41.85	43.78	0.922	0.964	1.009	186	198	210

10	38.11	39.88	41.68	0.960	1.002	1.047	194	205	218
11	36.37	38.02	39.69	0.998	1.041	1.087	201	213	226
12	34.71	36.25	37.81	1.038	1.081	1.127	209	221	234
13	33.14	34.57	36.03	1.078	1.122	1.168	218	230	242
14	31.65	32.98	34.34	1.119	1.163	1.210	226	238	251
15	30.23	31.47	32.74	1.161	1.206	1.252	235	247	259
16	28.88	30.04	31.22	1.204	1.249	1.295	244	256	268
17	27.61	28.69	29.78	1.248	1.292	1.339	252	265	277
18	26.39	27.40	28.41	1.292	1.337	1.384	262	274	286
19	25.24	26.17	27.12	1.337	1.382	1.429	271	283	296
20	24.14	25.01	25.89	1.383	1.428	1.475	280	293	305
21	23.09	23.90	24.72	1.430	1.475	1.521	290	302	315
22	22.10	22.85	23.61	1.477	1.522	1.568	300	312	324
23	21.16	21.85	22.55	1.525	1.570	1.616	309	321	334
24	20.26	20.90	21.55	1.574	1.618	1.664	319	331	344
25	19.40	20.00	20.60	1.623	1.667	1.712	329	341	354
26	18.55	19.14	19.73	1.670	1.716	1.763	339	351	364
27	17.74	18.32	18.91	1.718	1.765	1.814	349	362	375
28	16.97	17.55	18.12	1.766	1.815	1.866	359	372	385
29	16.24	16.80	17.37	1.815	1.865	1.917	369	382	396
30	15.54	16.10	16.66	1.864	1.916	1.970	379	392	406
31	14.88	15.43	15.98	1.913	1.966	2.022	389	403	417
32	14.25	14.79	15.33	1.962	2.017	2.074	399	413	428
33	13.65	14.18	14.71	2.011	2.068	2.127	409	424	439
34	13.08	13.59	14.12	2.061	2.119	2.179	419	434	449
35	12.53	13.04	13.55	2.111	2.170	2.231	429	444	460
36	12.01	12.51	13.01	2.160	2.221	2.284	439	455	471
37	11.52	12.00	12.50	2.210	2.272	2.336	450	465	481
38	11.05	11.52	12.01	2.260	2.323	2.388	460	476	492
39	10.60	11.06	11.54	2.309	2.374	2.440	470	486	503
40	10.17	10.62	11.09	2.358	2.425	2.492	480	497	513
41	9.757	10.20	10.66	2.408	2.475	2.543	490	507	524
42	9.367	9.803	10.25	2.457	2.525	2.594	500	517	534
43	8.994	9.420	9.856	2.506	2.575	2.645	510	527	545
44	8.638	9.054	9.480	2.554	2.624	2.695	520	537	555
45	8.298	8.705	9.121	2.602	2.673	2.745	530	547	565
46	7.973	8.371	8.778	2.650	2.722	2.794	540	557	575
47	7.663	8.051	8.449	2.698	2.770	2.843	549	567	585
48	7.367	7.745	8.134	2.745	2.818	2.891	559	577	595
49	7.083	7.453	7.832	2.792	2.865	2.939	569	587	605
50	6.812	7.176	7.543	2.838	2.911	2.986	578	596	615
51	6.553	6.905	7.267	2.883	2.958	3.032	588	606	624
52	6.305	6.649	7.002	2.929	3.003	3.078	597	615	633
53	6.068	6.403	6.747	2.974	3.048	3.123	606	624	643
54	5.841	6.168	6.504	3.018	3.093	3.168	615	633	652
55	5.623	5.942	6.270	3.061	3.136	3.212	624	642	661
56	5.415	5.726	6.046	3.104	3.179	3.255	633	651	670
57	5.216	5.519	5.831	3.147	3.222	3.297	641	660	678

58	5.025	5.321	5.625	3.188	3.263	3.339	650	668	687
59	4.842	5.131	5.428	3.229	3.304	3.380	658	677	695
60	4.667	4.948	5.238	3.270	3.345	3.420	667	685	703
61	4.499	4.773	5.055	3.310	3.385	3.459	675	693	711
62	4.338	4.605	4.880	3.349	3.423	3.498	683	701	719
63	4.183	4.444	4.712	3.388	3.462	3.536	691	709	727
64	4.035	4.289	4.551	3.425	3.499	3.573	699	717	735
65	3.893	4.140	4.396	3.463	3.536	3.609	706	724	742
66	3.756	3.998	4.247	3.499	3.572	3.645	714	732	749
67	3.625	3.861	4.103	3.535	3.607	3.679	721	739	757
68	3.500	3.729	3.966	3.570	3.642	3.713	728	746	763
69	3.379	3.603	3.833	3.604	3.676	3.747	735	753	770
70	3.263	3.481	3.706	3.638	3.709	3.779	742	760	777
71	3.152	3.364	3.583	3.671	3.741	3.811	749	766	783
72	3.045	3.252	3.466	3.703	3.773	3.842	755	773	790
73	2.942	3.144	3.352	3.735	3.804	3.872	762	779	796
74	2.843	3.040	3.243	3.766	3.834	3.902	768	785	802
75	2.748	2.940	3.138	3.797	3.864	3.931	775	791	808
76	2.657	2.844	3.037	3.826	3.893	3.959	781	797	814
77	2.569	2.751	2.940	3.855	3.921	3.986	787	803	819
78	2.485	2.662	2.846	3.884	3.949	4.013	792	809	825
79	2.403	2.577	2.756	3.911	3.976	4.039	798	814	830
80	2.325	2.494	2.669	3.938	4.002	4.064	804	820	835
81	2.250	2.415	2.585	3.965	4.027	4.089	809	825	840
82	2.178	2.338	2.504	3.991	4.053	4.113	814	830	845
83	2.108	2.264	2.426	4.016	4.077	4.137	819	835	850
84	2.041	2.193	2.351	4.040	4.101	4.159	824	840	855
85	1.976	2.125	2.279	4.064	4.124	4.182	829	845	859
86	1.914	2.059	2.209	4.088	4.146	4.203	834	849	864
87	1.854	1.995	2.142	4.111	4.168	4.225	839	854	868
88	1.796	1.934	2.077	4.133	4.190	4.245	843	858	872
89	1.740	1.875	2.014	4.155	4.211	4.265	848	862	877
90	1.687	1.818	1.954	4.176	4.231	4.284	852	866	880
91	1.635	1.763	1.895	4.197	4.251	4.303	856	871	884
92	1.585	1.710	1.839	4.217	4.270	4.322	861	874	888
93	1.537	1.659	1.785	4.236	4.289	4.340	865	878	892
94	1.490	1.609	1.732	4.256	4.307	4.357	869	882	895
95	1.446	1.561	1.681	4.274	4.325	4.374	872	886	899
96	1.402	1.515	1.632	4.292	4.342	4.391	876	889	902
97	1.360	1.471	1.585	4.310	4.359	4.407	880	893	905
98	1.320	1.428	1.539	4.327	4.375	4.422	883	896	909
99	1.281	1.386	1.495	4.344	4.391	4.437	887	899	912
100	1.243	1.346	1.452	4.360	4.407	4.452	890	903	915
101	1.207	1.307	1.411	4.376	4.422	4.466	893	906	918
102	1.172	1.270	1.371	4.392	4.437	4.480	896	909	921
103	1.137	1.233	1.332	4.407	4.451	4.494	900	912	923
104	1.104	1.198	1.295	4.422	4.465	4.507	903	914	926
105	1.070	1.164	1.258	4.436	4.479	4.521	906	917	929

Temperature sensor R-T analysis table (50K)

Sensor standard resistance : 50K Ω \pm 2% B:B(25/50)=3950K \pm 2% reference temperature : 25 ($^{\circ}$ C)

MCU_A/D exchange \pm 2LSB (at8bit)

Series (sampling) resistor : 5.1 (K Ω) \pm 1%

Single chip (A/D reference voltage) supply voltage : 5V

Temp ($^{\circ}$ C)	Resistance (K Ω)			MCU Input voltage (V)			A/D Exchange value		
	MIN	TYP	MAX	MIN	TYP	MAX	MIN	TYP	MAX
-20	465.7	486.2	507.3	0.049	0.052	0.055	1	3	5
-19	439.7	458.7	478.3	0.052	0.055	0.058	1	3	5
-18	415.2	432.9	451.2	0.055	0.058	0.061	1	3	5
-17	392.2	408.8	425.8	0.059	0.062	0.065	1	3	5
-16	370.7	386.1	402	0.062	0.065	0.069	1	3	6
-15	350.5	364.8	379.6	0.066	0.069	0.072	1	4	6
-14	331.5	344.9	358.6	0.069	0.073	0.077	2	4	6
-13	313.7	326.2	339	0.073	0.077	0.081	2	4	6
-12	296.9	308.6	320.5	0.078	0.081	0.085	2	4	6
-11	281.2	292	303.2	0.082	0.086	0.090	2	4	7
-10	266.4	276.5	286.9	0.086	0.091	0.095	2	5	7
-9	252.4	261.8	271.5	0.091	0.096	0.100	3	5	7
-8	239.3	248.1	257.1	0.096	0.101	0.105	3	5	7
-7	226.9	235.1	243.6	0.102	0.106	0.111	3	5	8
-6	215.2	222.9	230.8	0.107	0.112	0.117	3	6	8
-5	204.3	211.5	218.8	0.113	0.118	0.123	4	6	8
-4	193.9	200.6	207.5	0.119	0.124	0.129	4	6	9
-3	184.1	190.4	196.8	0.125	0.130	0.136	4	7	9
-2	174.9	180.8	186.8	0.132	0.137	0.143	5	7	9
-1	166.2	171.7	177.3	0.138	0.144	0.150	5	7	10
0	158	163.1	168.4	0.146	0.152	0.158	5	8	10
1	150.2	155	159.9	0.153	0.159	0.166	6	8	10
2	142.9	147.4	152	0.161	0.167	0.174	6	9	11
3	136	140.2	144.5	0.169	0.175	0.182	7	9	11
4	129.4	133.3	137.4	0.177	0.184	0.191	7	9	12
5	123.2	126.9	130.6	0.186	0.193	0.201	8	10	12
6	117.3	120.8	124.3	0.195	0.203	0.210	8	10	13
7	111.8	115	118.3	0.205	0.212	0.220	8	11	13
8	106.5	109.6	112.6	0.215	0.222	0.231	9	11	14
9	101.5	104.4	107.2	0.225	0.233	0.241	10	12	14
10	96.82	99.47	102.2	0.235	0.244	0.253	10	12	15
11	92.34	94.83	97.35	0.247	0.255	0.264	11	13	16
12	88.1	90.43	92.79	0.258	0.267	0.276	11	14	16
13	84.08	86.26	88.47	0.270	0.279	0.289	12	14	17
14	80.26	82.31	84.37	0.282	0.292	0.302	12	15	17
15	76.64	78.55	80.49	0.295	0.305	0.315	13	16	18
16	73.2	74.99	76.8	0.308	0.318	0.329	14	16	19
17	69.93	71.62	73.31	0.322	0.332	0.343	14	17	20
18	66.83	68.41	69.99	0.336	0.347	0.358	15	18	20

19	63.88	65.36	66.85	0.351	0.362	0.373	16	19	21
20	61.08	62.47	63.86	0.366	0.377	0.389	17	19	22
21	58.42	59.72	61.02	0.382	0.393	0.405	18	20	23
22	55.88	57.1	58.32	0.398	0.410	0.422	18	21	24
23	53.47	54.61	55.76	0.415	0.427	0.439	19	22	24
24	51.18	52.25	53.32	0.433	0.445	0.457	20	23	25
25	49	50	51	0.450	0.463	0.476	21	24	26
26	46.88	47.86	48.84	0.468	0.481	0.495	22	25	27
27	44.87	45.82	46.78	0.487	0.501	0.515	23	26	28
28	42.95	43.88	44.82	0.506	0.521	0.535	24	27	29
29	41.12	42.03	42.95	0.526	0.541	0.557	25	28	30
30	39.38	40.27	41.17	0.546	0.562	0.578	26	29	32
31	37.73	38.59	39.47	0.567	0.584	0.601	27	30	33
32	36.15	37	37.85	0.588	0.606	0.624	28	31	34
33	34.64	35.47	36.3	0.611	0.629	0.647	29	32	35
34	33.21	34.02	34.83	0.633	0.652	0.671	30	33	36
35	31.84	32.63	33.42	0.656	0.676	0.696	32	35	38
36	30.54	31.31	32.08	0.680	0.700	0.722	33	36	39
37	29.29	30.04	30.8	0.704	0.726	0.748	34	37	40
38	28.11	28.84	29.58	0.729	0.751	0.774	35	38	42
39	26.97	27.69	28.41	0.755	0.778	0.802	37	40	43
40	25.89	26.59	27.29	0.781	0.805	0.830	38	41	44
41	24.86	25.54	26.22	0.807	0.832	0.858	39	43	46
42	23.87	24.53	25.2	0.835	0.861	0.887	41	44	47
43	22.93	23.57	24.23	0.862	0.889	0.917	42	46	49
44	22.03	22.66	23.29	0.891	0.919	0.948	44	47	51
45	21.17	21.78	22.4	0.920	0.949	0.978	45	49	52
46	20.34	20.94	21.54	0.949	0.979	1.010	47	50	54
47	19.56	20.14	20.73	0.979	1.010	1.042	48	52	55
48	18.8	19.37	19.94	1.010	1.042	1.075	50	53	57
49	18.08	18.63	19.2	1.041	1.075	1.109	51	55	59
50	17.39	17.93	18.48	1.073	1.107	1.143	53	57	61
51	16.73	17.26	17.79	1.105	1.140	1.177	55	58	62
52	16.1	16.61	17.13	1.138	1.175	1.212	56	60	64
53	15.5	15.99	16.5	1.172	1.209	1.247	58	62	66
54	14.92	15.4	15.9	1.205	1.244	1.283	60	64	68
55	14.36	14.83	15.32	1.239	1.279	1.320	61	66	70
56	13.83	14.29	14.76	1.274	1.315	1.357	63	67	71
57	13.32	13.77	14.23	1.309	1.351	1.394	65	69	73
58	12.83	13.27	13.71	1.346	1.388	1.432	67	71	75
59	12.36	12.79	13.22	1.382	1.425	1.471	69	73	77
60	11.91	12.33	12.75	1.418	1.463	1.510	71	75	79
61	11.48	11.89	12.3	1.455	1.501	1.549	73	77	81
62	11.07	11.46	11.87	1.492	1.540	1.588	74	79	83
63	10.67	11.06	11.45	1.530	1.578	1.628	76	81	85
64	10.29	10.67	11.05	1.568	1.617	1.668	78	83	87
65	9.927	10.29	10.66	1.607	1.657	1.708	80	85	89
66	9.577	9.931	10.29	1.646	1.696	1.749	82	87	92

67	9.24	9.585	9.94	1.684	1.736	1.790	84	89	94
68	8.916	9.253	9.599	1.723	1.777	1.831	86	91	96
69	8.605	8.934	9.271	1.763	1.817	1.872	88	93	98
70	8.307	8.627	8.955	1.803	1.858	1.914	90	95	100
71	8.02	8.331	8.652	1.843	1.899	1.955	92	97	102
72	7.744	8.048	8.36	1.883	1.939	1.997	94	99	104
73	7.479	7.775	8.079	1.923	1.981	2.039	96	101	106
74	7.224	7.512	7.809	1.963	2.022	2.081	99	104	109
75	6.979	7.26	7.549	2.004	2.063	2.123	101	106	111
76	6.743	7.017	7.299	2.044	2.104	2.165	103	108	113
77	6.516	6.783	7.059	2.085	2.146	2.208	105	110	115
78	6.298	6.558	6.827	2.126	2.187	2.250	107	112	117
79	6.088	6.342	6.603	2.167	2.229	2.292	109	114	119
80	5.886	6.133	6.388	2.207	2.270	2.334	111	116	121
81	5.691	5.932	6.181	2.248	2.311	2.375	113	118	124
82	5.504	5.739	5.982	2.289	2.353	2.417	115	120	126
83	5.323	5.552	5.789	2.329	2.394	2.459	117	123	128
84	5.149	5.373	5.604	2.370	2.435	2.500	119	125	130
85	4.982	5.2	5.425	2.410	2.476	2.542	121	127	132
86	4.82	5.033	5.253	2.450	2.517	2.583	123	129	134
87	4.665	4.872	5.087	2.491	2.557	2.624	126	131	136
88	4.515	4.717	4.927	2.531	2.598	2.664	128	133	138
89	4.371	4.568	4.772	2.571	2.638	2.705	130	135	140
90	4.232	4.424	4.623	2.610	2.677	2.745	132	137	143
91	4.097	4.285	4.479	2.650	2.717	2.785	134	139	145
92	3.968	4.151	4.341	2.688	2.756	2.824	136	141	147
93	3.843	4.021	4.207	2.727	2.796	2.864	138	143	149
94	3.722	3.897	4.077	2.766	2.834	2.903	140	145	151
95	3.606	3.776	3.952	2.805	2.873	2.941	142	147	153
96	3.494	3.66	3.832	2.843	2.911	2.979	144	149	155
97	3.386	3.548	3.716	2.880	2.949	3.017	145	151	156
98	3.281	3.439	3.603	2.918	2.986	3.054	147	153	158
99	3.181	3.335	3.495	2.955	3.023	3.091	149	155	160
100	3.083	3.233	3.39	2.991	3.060	3.128	151	157	162
101	2.989	3.136	3.288	3.028	3.096	3.164	153	159	164
102	2.898	3.041	3.19	3.064	3.132	3.200	155	160	166
103	2.811	2.95	3.096	3.099	3.168	3.235	157	162	168
104	2.726	2.862	3.004	3.135	3.203	3.270	159	164	169
105	2.644	2.777	2.916	3.169	3.237	3.304	160	166	171
106	2.565	2.695	2.83	3.204	3.271	3.338	162	167	173
107	2.488	2.615	2.748	3.238	3.305	3.372	164	169	175
108	2.415	2.538	2.667	3.272	3.339	3.404	166	171	176
109	2.343	2.464	2.59	3.305	3.371	3.437	167	173	178
110	2.274	2.392	2.515	3.338	3.404	3.469	169	174	180
111	2.207	2.323	2.443	3.370	3.435	3.500	171	176	181
112	2.143	2.255	2.373	3.401	3.467	3.531	172	178	183
113	2.08	2.19	2.305	3.433	3.498	3.562	174	179	184
114	2.02	2.127	2.239	3.464	3.528	3.592	175	181	186

115	1.961	2.066	2.176	3.494	3.558	3.621	177	182	187
116	1.905	2.007	2.114	3.524	3.588	3.650	178	184	189
117	1.85	1.95	2.055	3.554	3.617	3.679	180	185	190
118	1.797	1.895	1.997	3.583	3.645	3.707	181	187	192
119	1.746	1.841	1.941	3.612	3.674	3.734	183	188	193
120	1.696	1.789	1.887	3.640	3.702	3.762	184	190	195
121	1.648	1.739	1.834	3.668	3.729	3.788	186	191	196
122	1.602	1.69	1.784	3.695	3.756	3.814	187	192	197
123	1.556	1.643	1.734	3.722	3.782	3.840	189	194	199
124	1.513	1.598	1.687	3.748	3.807	3.865	190	195	200
125	1.471	1.554	1.641	3.774	3.832	3.889	191	196	201
126	1.43	1.511	1.596	3.799	3.857	3.914	193	197	202
127	1.39	1.469	1.552	3.824	3.882	3.937	194	199	204
128	1.351	1.429	1.51	3.849	3.906	3.961	195	200	205
129	1.314	1.39	1.469	3.873	3.929	3.984	196	201	206
130	1.278	1.352	1.43	3.896	3.952	4.006	197	202	207
131	1.243	1.315	1.391	3.920	3.975	4.028	199	204	208
132	1.209	1.28	1.354	3.943	3.997	4.050	200	205	209
133	1.176	1.245	1.318	3.965	4.019	4.071	201	206	210
134	1.144	1.212	1.283	3.987	4.040	4.091	202	207	211
135	1.113	1.179	1.249	4.008	4.061	4.112	203	208	213
136	1.083	1.148	1.216	4.030	4.081	4.131	204	209	214
137	1.054	1.117	1.184	4.050	4.102	4.151	205	210	215
138	1.026	1.088	1.153	4.070	4.121	4.169	206	211	215
139	0.9986	1.059	1.123	4.090	4.140	4.188	207	212	216
140	0.9721	1.031	1.093	4.110	4.159	4.206	208	213	217
141	0.9463	1.004	1.065	4.129	4.178	4.224	209	214	218
142	0.9213	0.9778	1.037	4.148	4.196	4.241	210	215	219
143	0.897	0.9523	1.011	4.166	4.213	4.258	211	216	220
144	0.8734	0.9275	0.9845	4.184	4.231	4.275	212	217	221
145	0.8505	0.9034	0.9593	4.202	4.248	4.291	213	217	222
146	0.8283	0.8801	0.9347	4.219	4.264	4.307	214	218	223
147	0.8068	0.8574	0.9108	4.236	4.280	4.323	215	219	223
148	0.7858	0.8354	0.8877	4.252	4.296	4.338	216	220	224
149	0.7655	0.814	0.8652	4.269	4.312	4.353	217	221	225
150	0.7458	0.7932	0.8433	4.284	4.327	4.368	217	222	226

